

ABOUT US



SINCE 1978 CAMERON ENTERPRISES, LTD has built a reputation for excellence in products and service, with a constant focus on helping your business grow in a constantly changing market. Our business was created to help businesses like yours focus on your field of expertise- we take the guess work out of sourcing quality materials. With years of experience in the field and proven results we strive to exceed your expectations.

The principles of our business have remained steadfast through the years- quality, consistency, and dependability.

WE'LL SOURCE QUALITY MATERIALS TIME AND TIME AGAIN: Your results are too important to trust to amateur, pop-up web shops or inconsistent logistic companies. We deliver every time and we stand by our products.

WE KNOW THE INS AND OUTS OF OUR FIELD: The difference, in one word, is experience. From sourcing material to making deadlines our warehouse personnel, sales team, and management have it in spades.

WE'RE NOT JUST A VENDOR, WE'RE YOUR PARTNER : Supply needs to fluctuate, grow, and evolve in ways you might be able to anticipate. We can help create not just a solution, but a consistent supply strategy to help take your business to the next level.

Thank you for your interest. We understand that you have a choice in suppliers and we want to make sure that our company is high on your list. We look forward to working with you,

CAMERON ENTERPRISES LTD.



TABLE OF CONTENTS

HARDWARE - GATE

HINGES	1-4
ROLLERS	5
WHEEL BOXES	5
BOLTS AND LATCHES	6
WHEELS AND TRACK WHEELS	7-9
FASTENERS	10-11

METAL STAMPINGS

WELD TABS	12-13
BASE PLATES	14
STEEL DISCS	15
HANDRAIL BRACKETS	16
METAL RINGS	17
SPHERES	18
PRESSED STEEL POST CAPS	18

FITTINGS

PIPE FITTINGS	19
PIPE FLANGE	19

PLASTIC

PLASTIC POST CAPS	20
PLASTIC SPEARS	20

HARDWARE - DOOR

LOCK SETS - MORTISE	21-22
LOCK SETS - SLIMLINE MORTISE	22-23
LOCK SETS - EZSET	24-25
LOCK SETS - CEL	24-26
LOCK SETS - SNAP-IN DEADBOLT	26
LOCK SETS - HOOK LOCKS	27
LOCK SETS - DIGITAL PUSH BUTTON LOCKS	27
LOCK BOXES	28-29
MAIL SLOTS	30
DOOR CLOSERS	30-31
WINDOW RELEASE	32
TUBE BENDER	32

TABLE OF CONTENTS

CAST IRON

CAST IRON SPEARS	33-37
CAST IRON DRIVE-INS	38
CAST IRON CAPS	39
CAST IRON COLLARS	40
CAST IRON SHOES	41-42
CAST IRON ROSETTES, RINGS, SPHERES	43
CAST IRON RAILENDS	44-45
CAST IRON HANDRAIL BRACKETS	45
CAST IRON ORNAMENTAL CASTINGS	46-50
CAST IRON LATERALS AND CHANNELS	50
CAST IRON POSTS	51

ALUMINUM

ALUMINUM PICKETS	52-54
ALUMINUM ROSE DESIGN	55-56
ALUMINUM BIRDS OF PARADISE DESIGN	56
ALUMINUM OAK DESIGN	57-58
ALUMINUM GRAPE DESIGN	58-59
ALUMINUM LION DESIGN	59
ALUMINUM PALM TREE/EAGLE/HORSE DESIGN	60-61
ALUMINUM PONTALBA DESIGN	62
ALUMINUM CONTEMPORARY DESIGN	63
ALUMINUM IVY DESIGN	63
ALUMINUM STORM DOOR CASTINGS	64-65
ALUMINUM HANDRAIL BRACKETS	66
ALUMINUM SPEARS, CAPS, SHOES	67--68

DUCTILE IRON

DUCTILE IRON BALLS	69
DUCTILE IRON HANDRAIL BRACKETS	69
DUCTILE IRON BALUSTER	70-71
DUCTILE IRON PANELS	71
DUCTILE IRON SHOES	72
DUCTILE IRON RAILENDS	73-74

STEEL FORGINGS

BALUSTERS TWISTED DESIGN	75-77
BALUSTERS STAIR AND RAIL DESIGN	78-83
BALUSTERS ROUND DESIGN	84
STEEL TUBE COMPONENTS	85
FORGED NEWEL POSTS	86
BALCONY ELEMENTS	87

TABLE OF CONTENTS

TUBING SCROLLS

FISHTAIL STYLE SCROLLS	88
SCRIL STYLE SCROLLS	89

SCROLL FORGINGS

SCROLLS - SNAP ON DESIGN	90
SCROLLS - FISH TAIL DESIGN	91-92
SCROLLS - LEAF DESIGNS	93
SCROLLS - TIGHT CURL HAMMERED DESIGN	94
SCROLLS - TIGHT CURL EDGE-GROOVED DESIGN	95
SCROLLS - LEAF DESIGN EDGE-GROOVED	96
SCROLLS - ROUND BAR DESIGN	97-98

DECORATIVE PANEL

DECORATIVE PANEL - ROSETTE DESIGN	99
DECORATIVE PANEL - PONTALBA DESIGN	100
DECORATIVE PANEL - HEART AND FLORAL DESIGN	101
DECORATIVE PANEL - SCROLL DESIGN	102-104

FORGINGS

FORGINGS – FLORAL ELEMENTS	105-107
FORGINGS - GRAPES	108

CAST STEEL ELEMENTS

CAST STEEL - SPEARS	109
CAST STEEL – FLORAL ELEMENTS	110-111

STAMPINGS

STAMPINGS – FLORAL ELEMENTS	112-113
PRESSED SHEET METAL – FLORAL ELEMENTS	114-117

SPHERES & BASKETS

SPHERES	118
BASKETS	118

DECORATIVE BAR

DECORATIVE FLAT BAR	119
DECORATIVE ROUND BAR	120
END PIECES FOR HANDRAILS	121

TERMS AND CONDITIONS

- TERMS OF PAYMENT:** NET 30 days with approved credit. 1-1/2% per month interest charge on past due balances. A \$25.00 service fee will be charged for each returned check.
- NEW ACCOUNTS:** New accounts will be shipped under C.O.D terms until credit application has been submitted and approved.
- PRICING:** All prices are subject to change without notice.
- FREIGHT:** Prices are F.O.B. Arcadia, California.
- LIMITED WARRANTY:** All our products are guaranteed against faulty workmanship and/or defective materials. Defective products will be replaced free of charge. Our liability and responsibility are limited to replacement of parts only. A high quality clear protective coating is applied to the exterior surface of our brass products. However, if exposed to corrosive vapors, humid climates, sea air or salt spray, this protective coating can be damaged rapidly. Therefore, finishes on metal surfaces will not be included in our limited warranty.
- RETURN POLICY:** The following is regarding all returned items to our warehouse.
- No returns will be accepted unless authorized by a representative of Cameron Enterprises Ltd. prior to return. Credit will be issued upon inspection of goods.
- We must be notified of a return within 15 days of purchase.
 - A restocking fee of 15% will apply on all returns.
 - No returns will be accepted after 30 days.
 - Must have an authorization number.
 - Must have packing list or invoice from original purchase
 - Must be in original packaging
 - Must use credit within 90 days.
- LOSS AND DAMAGES:** Any claim for loss or damage in transit must be made against the carrier that delivered upon receipt of orders. Damages or shortages must be reported within 2 working days of receipt.
- DISCLAIMER NOTICE:** Cameron Enterprises, Ltd. reserves the right to revise this catalog, its listings, descriptions, and illustrations as market conditions, company policy, or other conditions may require without additional notice.

HARDWARE - HINGES



WELDABLE BUTT HINGE (TIGHT PIN/BRIGHT STEEL)

Item#	Size	Gauge	PCS./Bx	Swaged	Cap.	Wgt.
HD-HSD22	2"x2"	14	400	Yes		53 lbs.
HD-HSD33	3"x3"	13	200	Yes		59 lbs.
HD-HSD3134	3"x1-3/4"	12	200	Yes		64 lbs.
HD-HSD35225	3-1/2"x2-1/4"	12	200	Yes		64 lbs.
HD-HSD3535	3-1/2"x3-1/2"	12	100	Yes		45 lbs.
HD-HSD44	4"x4"	12	100	Yes		58 lbs.

Non-removable pin



BARREL HINGE

Item	Size	Barrel Dia.	Pin	Bearing	Plate	PCS./Bx	Wgt.
HD-HB2	2"	5/8"	Steel	No	No	400	62 lbs.
HD-HB3	3"	3/4"	Steel	No	No	200	74 lbs.
HD-HB5*	5"	1"	S/S	Ball	Yes	40	54 lbs.
HD-HB5NS	5"	1"	Steel	Ball	Yes	40	51 lbs.
HD-HB5NSNP	5"	1"	Steel	Ball	No	40	46 lbs.
HD-HB7*	7"	1-1/4"	S/S	Ball	Yes	16	51 lbs.
HD-HB7NS	7"	1-1/4"	Steel	Ball	Yes	16	51 lbs.
HD-HB7NSNP	7"	1-1/4"	Steel	Ball	No	16	46 lbs.
HD-HB9*	9"	2"	S/S	Ball	Yes	6	62 lbs.
HD-HB9NP*	9"	2"	S/S	Ball	No	8	63 lbs.

*S/S denotes Stainless Steel Pin



HEAVY DUTY BUTT HINGE (NON-SWAGED)

Item#	Size	Gauge	PCS./Bx	Capacity	Wgt.
HD-HHD33	3"x3"	0.125"	100	No	44 lbs.
HD-HHD44	4"x4"	0.178"	50	No	55 lbs.
HD-HHD55	5"x5"	0.198"	40	No	66 lbs.
HD-HHD66	6"x6"	0.198"	20	No	53 lbs.

Non-removable pin



WELD-ON TEARDROP HINGE (STEEL)

Item#	Height	Width	PCS./Bx	Finish	Wgt.
HD-HT3	4-3/4"	3/4"	100	Mill	38 lbs.
HD-HT5	5"	3/4"	50	Mill	40 lbs.
HD-HT7	7-7/8"	1-1/8"	30	Mill	44 lbs.

HARDWARE - HINGES

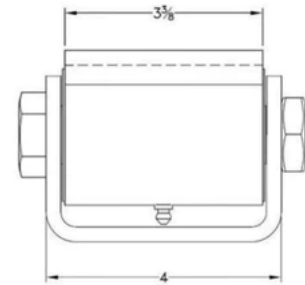
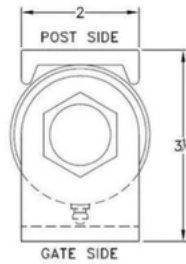

Roller Cage Bearings

Dependable Roller Cage Bearing Design

Even Weight Distribution

Largest Weld Surface in the Industry

Easy to Fully Lubricate

HEAVY DUTY ROLLER CAGE BEARING HINGE

Item	Size (in.)	H	W	Cap.	Wgt	Pk
HD-HBX35	3-1/2"	3.5"	2"	3,000 lbs/pr	57 lbs.	8/bx
HD-HBX4	4"	4"	2"	3,500 lbs/pr	65lbs.	8/bx

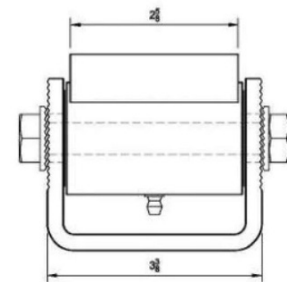
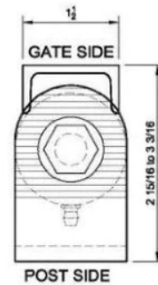

ADJUSTABLE ROLLER CAGE BEARING HINGE

Item	Size (in.)	H	W	Cap	Wgt	Pk
HD-HBX35ADJ	3-1/2"	3-1/2"	2-15/16 to 3-3/16"	1,000 lbs/pr	57 lbs.	12/bx

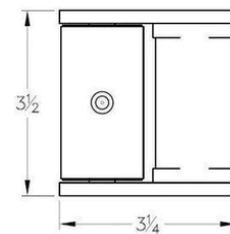
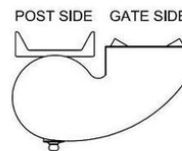

TAMPER PROOF ROLLER CAGE BEARING HINGE

Item	Size (in.)	H	W	Cap	Wgt	Pk
HD-HBX35T	3-1/2"	3-1/2"	3-1/4"	1,000 lbs/pr	57 lbs.	12/bx

HARDWARE - HINGES

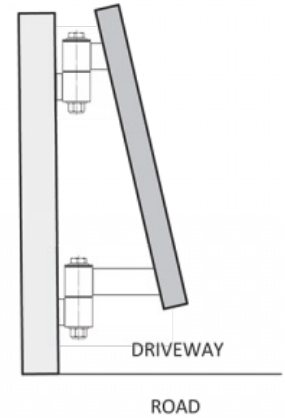
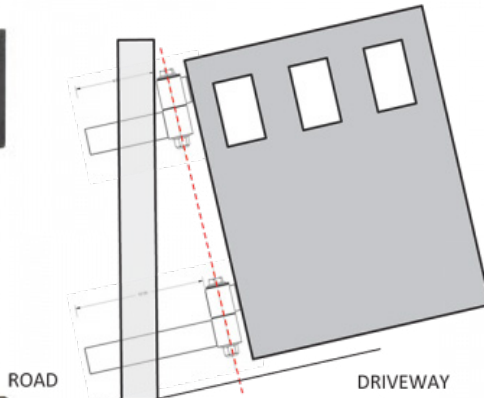
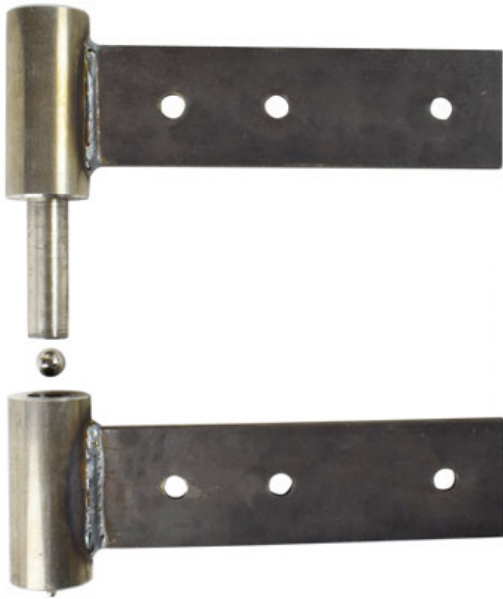

Uphill Swing Hinge

Weld-on or bolt-on option

Convenient grease fitting

Maximum Gate Weight: HD-HU7: 800 lbs. HD-HU9: 1,000 lbs.

Ideal for flat post installation

UPHILL SWING HINGE

Item	Size (in.)	H	L	W	Wgt	Pk
HD-HU7	7"	7"	10"	5/8"	37 lbs.	6/bx
HD-HU9	9"	9"	10"	5/8"	53 lbs.	4/bx



BATWING - FEMALE

Item	Size (in.)	H	L	W	Wgt	Pk
HD-BWF12	1/2"	1-1/16"	1-1/2"	1"	57 lbs.	500/bx
HD-BWF58	5/8"	1-1/4"	1-5/8"	1-1/8"	40 lbs.	300/bx
HD-BWF34	3/4"	1-5/16"	1-5/8"	1-1/4"	46 lbs.	300/bx



BATWING - MALE (ROD HEIGHT 1")

Item	Size (in.)	H	L	W	Wgt	Pk
HD-BWM12	1/2"	1-1/16"	1-1/2"	1"	86 lbs.	500/bx
HD-BWM58	5/8"	1-1/4"	1-5/8"	1-1/8"	54 lbs.	200/bx
HD-BWM34	3/4"	1-5/16"	1-5/8"	1-1/4"	55 lbs.	200/bx

HARDWARE - HINGES



DECORATIVE H-HINGE W/BRASS BUSHINGS

Item#	Finish	Size	Hole Dia.	PCS./Bx	Wgt.
HD-HHB	P.C. Black	2-5/8"X7"	1/4"	100	60 lbs.
HD-HHSP	Smooth	2-5/8"X7"	1/4"	100	60 lbs.
HD-HHW	P.C. White	2-5/8"X7"	1/4"	100	60 lbs.
HD-HHZ	Zinc Plated	2-5/8"X7"	1/4"	100	60 lbs.
HD-HHP	Plain	2-5/8"X7"	1/4"	100	60 lbs.

H-Hinges feature weldable steel and tight pin construction



ADJUSTABLE BARREL HINGE

Item#	Size	J-Bolt	Wgt.	PCS./box
HD-HB5ADJ	5/8"	4-3/8"	53 lbs.	40/box
HD-HB7ADJ	3/4"	6-3/4"	52 lbs.	16/box



SINGLE ACTION SPRING HINGE

Item#	Finish	Size	Pin	Wgt.	PCS./box
HD-HSP312B	Black	3-1/2"x3-1/2"	3/16"	39 lbs.	50/box
HD-HSP312M	Mill	3-1/2"x3-1/2"	3/16"	39 lbs.	50/box
HD-HSP4B	Black	4"x4"	3/8"	46 lbs.	50/box
HD-HSP4M	Mill	4"x4"	3/8"	46 lbs.	50/box
HD-HSP412M	Mill	4-1/2"x4-1/2"	3/8"	35 lbs.	30/box

HSP412 not available in Black



RECTANGULAR BLOCK HINGE

Item#	W	L	H	Wgt.	PCS./box
HD-HB5REC	1"	1-1/4"	5"	70 lbs.	40/box
HD-HB7REC	1-3/4"	1-1/4"	7"	36 lbs.	16/box

HARDWARE - GATE

RUBBER ROLLERS - WELDED

Item	Size	Pk	Wgt (lbs.)
HD-RR3	3"	40	44 lbs.
HD-RR6	6"	20	53 lbs.
HD-RR12	12"	10	42 lbs.
HD-RR3D	3"	40	47 lbs.
HD-RR6D	6"	20	56 lbs.
HD-RR12D	12"	10	43 lbs.

**"D" denotes disassemblable
Roller only available in: 3", 6", and 12"

HD PLASTIC ROLLERS - NON MARRING

Item	Size	Pk	Wgt (lbs.)
HD-NR3	3"	40	44 lbs.
HD-NR6	6"	20	36 lbs.
HD-NR12	12"	10	42 lbs.

GATE SPRING ROLLER

Item	HD-WSLG
Wheel Size	3" Swivel
Capacity (lbs.)	100 lbs.
Finish	Mill
Height (in.)	16-3/4"
Per/box	10
Weight	32 lbs.

ADJUSTABLE DOOR SPRING W/SCREWS

Item	Length	Pk	Wgt
HD-DS9	9"	80	53 lbs.
HD-DS12	12"	50	59 lbs.

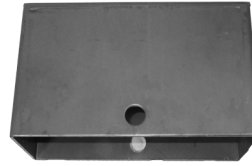

V-GROOVE WHEELBOXES

Item	L	W	H	Hole	Pk	Wgt
HD-BVG3	3-3/4"	2-1/8"	2-5/8"	1/2"	50	50 lbs.
HD-BVG4	4-1/2"	2-1/4"	3-1/2"	1/2"	24	35 lbs.
HD-BVG6	7"	2-3/4"	4-1/16"	3/4"	20	54 lbs.
HD-BVGSP6	7"	2-1/4"	4"	9/16"	20	50 lbs.

Constructed with 10 gauge steel



Locking

Heavy Duty

Standard

CANE BOLT

Item	Length	Bolt Dia.	Finish	Pk	Wgt
HD-BC1212	12" Cane Bolt	1/2"	Zinc	50	50 lbs.
HD-BC1812	18" Cane Bolt	1/2"	Zinc	40	54 lbs.
HD-BC2458	24" Cane Bolt	5/8"	Zinc	30	61 lbs.
HD-BCL12	22" Locking Cane Bolt	1/2"	Mill	25	45 lbs.
HD-BXC20	20" Heavy Duty Cane Bolt	3/4"	Black	10	52 lbs.

Cane bolt bracket available for individual purchase: HD-BCBRK

HARDWARE - GATE

GATE HANGER BOLT (GALVANIZED)

Item	Size	Pcs./ Bx	Weight (Box)
HD-BGHJZ (Zinc Plated)	1/2" x 4-1/2"	150	56 lbs.
HD-BGHJ (Galvanized)	1/2" x 4-1/2"	150	57 lbs.
HD-BGHJ58	5/8" x 4-1/2"	100	35 lbs.
HD-BGHJ34	3/4" x 7"	50	29 lbs.



Fancy Gate Latch



No Hole Gate Latch



Universal Gate Latch



XL Gate Latch

GATE LATCHES

Item	Desc.	Bar	Base	Plating	Pcs./Bx	Weight (Box)
HD-LFG	Fancy Gate Latch	9"	N/A	Mill	50	64 lbs.
HD-LNHG	No Hole Gate Latch	3-7/8"	1"	Mill	100	37.5 lbs.
HD-LUGGZ	Universal Gate Latch (w/Screw Holes)	5"	1-3/8"	Zinc	100	41 lbs.
HD-LUGGBXL	Extra Large Gate Latch	12"	2-1/8"	Black	30	58.5 lbs.

Latch bar available for individual purchase: HD-LBAR

SLIDE BOLT (WELDABLE)

Item	Size (in.)	Bolt Dia. (in.)	Pk	Wgt(lbs.)
HD-BHDS12	5-1/2"	1/2"	60	41 lbs.
HD-BXHDS34	9-1/2"	3/4"	20	52 lbs.



1/2" Slidebolt



3/4" Slidebolt

HARDWARE - ROLLING



Cast Iron



Nylon



Steel



Steel 3" w/ Bracket

Two sets of wheels are recommended for spanning lengths of 15 feet.

V-GROOVE CAST IRON / STEEL WHEELS

Item#	Material	Size (in.)	Width	Axle Dia. (in.)	Cap. per Pair (lbs.)	Finish	Pk	Wgt
HD-WVG3	Cast Iron	3"	1-1/2"	3/8"	600 lbs.	Black	30/box	49 lbs
HD-WVGB4*	Cast Iron	4"	1-1/2"	1/2"	1,000 lbs.	Black	20/box	57 lbs
HD-WVG6	Cast Iron	6"	2"	1/2"	1,200 lbs.	Black	10/box	70 lbs
HD-WVGSP3 w/ Bracket	Steel	3"	1-3/4"	3/8"	600 lbs.	Galv. Gold	24/box	69 lbs
HD-WVGSP4	Steel	4"	1-3/4"	1/2"	1,200 lbs.	Zinc	8/box	40 lbs
HD-WVGSP6	Steel	6"	1-3/4"	1/2"	2,000 lbs.	Chrome	4/box	46 lbs
HD-WVG4N	Nylon	4"	1-3/4"	5/8"	250 lbs.	Black	48/box	68 lbs

*HD-WVGB4 utilizes sealed bearings

HD-SBWVG4

**4" Cast Iron Single Bearing Wheel Premounted
4" V-groove box
Powder-coated black**

- Convenient preassembled package for rapid assembly
- Maintenance-free sealed bearing
- Fully lubricated
- Rated 3,000 lbs per pair.
- Excellent corrosion resistance

Packed 10 pcs/box
Weight 43 lbs/box



HARDWARE - ROLLING



2-Wheel Overhead Track Wheels



4-Wheel Overhead Track Wheels



HD Overhead Track Wheels

OVERHEAD TRACK WHEEL

Item#	Wheels	Dia.	Bolt Length	O.W.	I.W.	Wgt.	Pk
HD-OTC	2-Wheel OT	1-5/8"	4-1/4"	1-5/8"	15/16"	47 lbs.	60/box
HD-OTC4	4-Wheel OT	2-1/8"	4-7/8"	1-1/2"	15/16"	67 lbs.	60/box
HD-OTCH	4-Wheel HD OT	1-7/8"	6-1/4"	1-1/2"	1"	40 lbs.	20/box

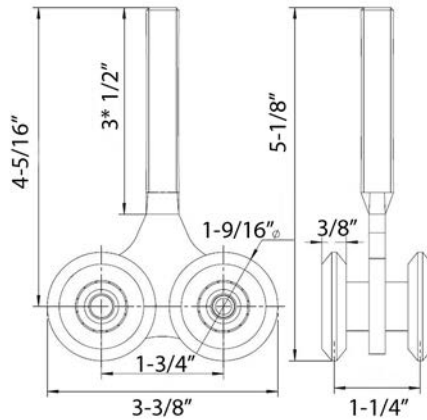

HD-OTCHX

Precision Bearing Overhead Track Carrier

Available for 1" and 1-1/4" Overhead rail

HD-OTCHX

HD-OTCHX114

- Steel bearings provide smooth action
- High strength cast-steel body
- Rated 450 lbs each

Packed 40 sets/box

Weight 60 lbs/box

HARDWARE - ROLLING



Polyurethane wheels offer great floor protection, water tolerance, and chemical/oil resistance.

CAST IRON POLYURETHANE CASTERS

Item#	Style	Size (in.)	Width	Plate Sz.	Cap. per Pair (lbs.)	Fork Mat.	Pk	Wgt
HD-WC4B	Brake	4"	2"	4"x4-1/2"	600 lbs.	1/8"	10/box	56 lbs
HD-WC4R	Rigid	4"	2"	4"x4-1/2"	600 lbs.	1/8"	14/box	56 lbs
HD-WC4S	Swivel	4"	2"	4"x4-1/2"	600 lbs.	1/8"	18/box	55 lbs
HD-WC5B	Brake	5"	2"	4"x4-1/2"	900 lbs.	1/8"	8/box	52 lbs
HD-WC5R	Rigid	5"	2"	4"x4-1/2"	900 lbs.	1/8"	8/box	50 lbs
HD-WC5S	Swivel	5"	2"	4"x4-1/2"	900 lbs.	1/8"	8/box	53 lbs
HD-WC6B	Brake	6"	2"	4"x4-1/2"	1,000 lbs.	1/8"	8/box	56 lbs
HD-WC6R	Rigid	6"	2"	4"x4-1/2"	1,000 lbs.	1/8"	8/box	50 lbs
HD-WC6S	Swivel	6"	2"	4"x4-1/2"	1,000 lbs.	1/8"	8/box	51 lbs



Rubber wheels are floor protective, quiet, and resist debris.

LIGHT DUTY RUBBER CASTERS

Item#	Style	Size (in.)	Width	Plate Sz.	Cap. per Pair (lbs.)	Hole Dia.	Pk	Wgt
HD-WR50B	Brake	2"	3/4"	2"x1-7/8"	55 lbs.	1/4"	200/box	44 lbs
HD-WR50R	Rigid	2"	3/4"	2-1/4"x2-3/4"	55 lbs.	1/4"	200/box	40 lbs
HD-WR50S	Swivel	2"	3/4"	2-1/4"x2-3/4"	55 lbs.	1/4"	200/box	40 lbs
HD-WR65B	Brake	2.5"	1"	2-1/4"x2-3/4"	65 lbs.	3/8"	100/box	54 lbs
HD-WR65R	Rigid	2.5"	1"	2-1/4"x2-3/4"	65 lbs.	3/8"	100/box	50 lbs
HD-WR65S	Swivel	2.5"	1"	2-1/4"x2-3/4"	65 lbs.	3/8"	100/box	50 lbs
HD-WR75B	Brake	3"	1"	2-1/4"x2-3/4"	75 lbs.	3/8"	80/box	56 lbs
HD-WR75R	Rigid	3"	1"	2-1/4"x2-3/4"	75 lbs.	3/8"	80/box	50 lbs
HD-WR75S	Swivel	3"	1"	2-1/4"x2-3/4"	75 lbs.	3/8"	80/box	50 lbs

HARDWARE - FASTENER

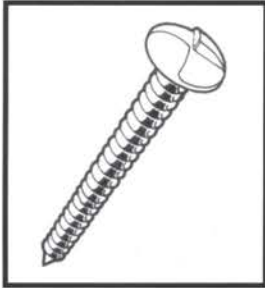

Black Oxide
Heat-Treated
Threaded Full Length
Truss Head

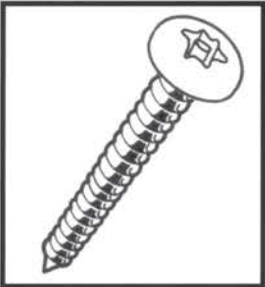

1018 Black Oxide Steel
Heat Treated
Threaded Full Length

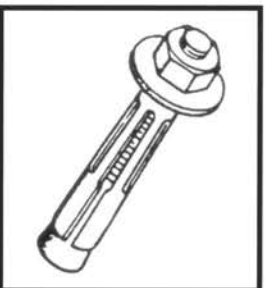

ONE WAY SCREW

Item	Size	Pk/box	Wgt/box
HD-SOWL11	1/4" x 1"	3500	48 lbs.
HD-SOWL115	1/4" x 1-1/2"	4,000	69 lbs.
HD-SOWL12	1/4" x 2"	2,000	43 lbs.
HD-SOWL125	1/4" x 2-1/2"	1,200	32 lbs.
HD-SOWL13	1/4" x 3"	1,000	31 lbs.
HD-SOWL515	5/16" x 1-1/2"	2,000	48 lbs.
HD-SOWL52	5/16" x 2"	1,000	34 lbs.
HD-SOWL53	5/16" x 3"	800	39 lbs.
HD-SOWL54	5/16" x 4"	500	32 lbs.
HD-SOWL55	5/16" x 5"	500	36 lbs.
HD-SOWL56	5/16" x 6"	400	35 lbs.

TORX TAMPER RESISTANT SCREW

Item	Size	Pk/box	Wgt/box
HD-ST14112	1/4" x 1-1/2"	2,000	43 lbs.
HD-ST142	1/4" x 2"	2,000	38 lbs.
HD-ST143	1/4" x 3"	1,000	55 lbs.

LAG SHIELD

Item	Size	Pk/box	Wgt/box
HD-LS516S	5/16" x 1-1/4"	1,000	43 lbs.
HD-LS516L	5/16" x 1-3/4"	1,000	38 lbs.
HD-LS38S	3/8" x 1-3/4"	1,000	55 lbs.
HD-LS38L	3/8" x 2-1/2"	500	57 lbs.

SLEEVE ANCHOR

Item	Size	Pk/box	Wgt/box
HD-SA516112	5/16" x 1-1/2"	1,000	41 lbs.
HD-SA516212	5/16" x 2-1/2"	1,000	57 lbs.
HD-SA38178	3/8" x 1-7/8"	700	56 lbs.
HD-SA383	3/8" x 3"	600	58 lbs.
HD-SA123	1/2" x 3"	250	48 lbs.

HARDWARE - FASTENER

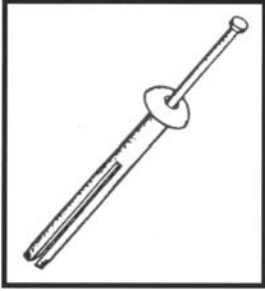

DRIVE-IN ANCHOR

Item	Size	Pk/box	Wgt/box
HD-ANI11	1/4" x 1"	2,500	50 lbs.
HD-ANI114	1/4" x 1-1/4"	2,000	44 lbs.
HD-ANI112	1/4" x 1-1/2"	2,000	50 lbs.
HD-ANI12	1/4" x 2"	1,250	40 lbs.



HEX HEAD LAG SCREW

Item	Size	Pk/box	Wgt/box
HD-SHX1	1/4" x 1"	3500	46 lbs.
HD-SHX115	1/4" x 1-1/2"	2500	50 lbs.
HD-SHX12	1/4" x 2"	2,000	48 lbs.
HD-SHX13	1/4" x 3"	1,500	32 lbs.
HD-SHX51	5/16" x 1"	2,000	48 lbs.
HD-SHX52	5/16" x 2"	1,000	40 lbs.
HD-SHX53	5/16" x 3"	800	45 lbs.
HD-SHX54	5/16" x 4"	600	46 lbs.
HD-SHX32	3/8" x 2"	800	36 lbs.
HD-SHX33	3/8" x 3"	600	49 lbs.
HD-SHX34	3/8" x 4"	400	43 lbs.

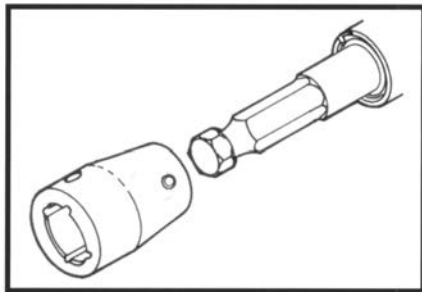

ONE-WAY ADAPTER

HD-TADPT

Adapter for 5/16" Tool
Packed 10 pcs/box

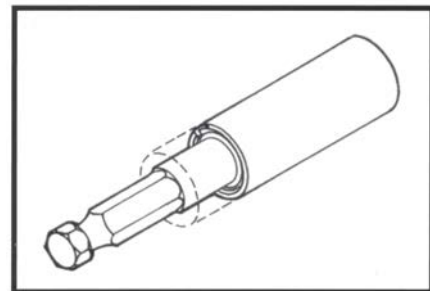

ONE-WAY DRIVER

HD-TOWD516

One Way Driver 5/16"
Packed 10 pcs/box

METAL STAMPING



WELD TAB 101		
Item	HD-WT101	HD-WT101XL
H	1-1/2"	1-1/2"
W	1"	1-1/2"
Thickness	1/8"	3/16"
Hole Dia.	3/8"	3/8"
Pk	1,000	200
Wgt	46 lbs.	22 lbs.



WELD TAB 105	
Item	HD-WT105
H	2-3/4"
W	2-5/8"
Base	7/8"
Thickness	1/8"
Hole Dia.	3/8"
Pk	500
Wgt	50 lbs.



WELD TAB 102		
Item	HD-WT102	HD-WT102XL
H	2-3/8"	2-3/8"
W	1"	1-1/2"
Thickness	1/8"	3/16"
Hole Dia.	3/8"	3/8"
Pk	1,000	250
Wgt	62 lbs.	34 lbs.



WELD TAB 106	
Item	HD-WT106
H	3-3/8"
W	2"
Thickness	1/8"
Hole Dia.	3/8"
Pk	500
Wgt	56 lbs.



WELD TAB 103	
Item	HD-WT103
H	2-1/2"
W	2"
Base	1"
Thickness	1/8"
Hole Dia.	3/8"
Pk	500
Wgt	46 lbs.



WELD TAB 107	
Item	HD-WT107
H	3-1/2"
W	1-1/2"
Thickness	3/16"
Hole Dia.	3/8"
Pk	250
Wgt	58 lbs.



HD-WT104



HD-WT104S

WELD TAB 104 "L BRACKET"			
Item	HD-WT104	HD-WT104XL	HD-WT104S
H	1-3/4"	1-3/4"	1-1/2"
W	1"	1-1/2"	1-1/2"
Length	3-1/2"	4"	1-1/2"
Thickness	3/16"	3/16"	3/16"
Hole Dia.	3/8"	3/8"	3/8"
Pk	250	150	250
Wgt	59 lbs.	60 lbs.	45 lbs.

METAL STAMPING



WELD TAB 108	
Item	HD-WT108
H	3-1/4"
W	1"
Thickness	1/8"
Hole Dia.	3/8"
Pk	500
Wgt	48 lbs.



WELD TAB 202	
Item	HD-WT202
L	4"
W	2"
Thickness	3/16"
Hole Dia.	3/8"
Pk	100
Wgt	38 lbs.



WELD TAB 109	
Item	HD-WT109
H	4"
W	1-1/2"
Thickness	3/16"
Hole Dia.	3/8"
Pk	200
Wgt	55 lbs.



WELD TAB 209	
Item	HD-WT209
L	5"
W	2"
Thickness	3/16"
Hole Dia.	3/8"
Pk	100
Wgt	41 lbs.



WELD TAB 204 WIDE "L BRACKET"		
Item	HD-WT204S	HD-WT204XL
H	2"	2"
W	2"	2"
Length	2"	4"
Thickness	3/16"	3/16"
Hole Dia.	3/8"	3/8"
Pk	150	100
Wgt	44 lbs.	53 lbs.

"We stand by our products with excellent customer service and consistent quality you can rely on."

METAL STAMPING



FENCE MOUNTING BRACKET (MILL FINISH)

Item#	Size	Hole	Thickness	Wgt.	Pk
HD-WT110*	1"	3/8"	3/16"	28 lbs.	100/box
HD-WT124	1-1/4"	3/8"	3/16"	30 lbs.	100/box
HD-WT125	1-1/2"	3/8"	3/16"	32 lbs.	100/box
HD-WT220	2"	3/8"	3/16"	55 lbs.	80/box

*HD-WT110 finished in powder-coated black.



BASE PLATE

Item#	Size	Hole Dia.	Thickness	Wgt.	Pk
HD-WT113	3"x3"	3/8"	5/32"	35 lbs.	100/box
HD-WT114	4"x4"	3/8"	5/32"	53 lbs.	80/box
HD-WT115	5"x5"	7/16"	1/4"	64 lbs.	40/box
HD-WT116	6"x6"	7/16"	1/4"	60 lbs.	25/box
HD-WT118	8"x8"	7/16"	1/4"	64 lbs.	16/box
HD-WT210	10"x10"	1/2"	5/16"	77 lbs.	8/box



BEVELED SQUARE BASE PLATE

Item#	Size	Hole Dia.	Thickness	Wgt.	Pk
HD-WT303B	3"	1/2"	3/16"	28 lbs.	60/box
HD-WT304B	4"	1/2"	3/16"	37 lbs.	45/box
HD-WT305B	5"	1/2"	3/16"	26 lbs.	20/box
HD-WT306B	6"	5/8"	3/16"	28 lbs.	15/box
HD-WT308B	8"	5/8"	1/4"	21 lbs.	5/box
HD-WT310B	10"	5/8"	1/4"	26 lbs.	4/box



BEVELED ROUND BASE PLATE

Item#	Size	Hole Dia.	Thickness	Wgt.	Pk
HD-WT5RB	4-3/4"	7/16"	3/16"	24 lbs.	25/box
HD-WT6RB	5-3/4"	7/16"	3/16"	27 lbs.	20/box
HD-WT7RB	6-3/4"	9/16"	1/4"	24 lbs.	10/box
HD-WT8RB	7-3/4"	9/16"	1/4"	15 lbs.	4/box

METAL STAMPING



90 DEGREE MOUNTING BRACKET

Item#	Size	Hole Dia.	Thickness	Wgt.	Pk
HD-MB3	2-5/16"	5/16"	3/16"	36 lbs.	40/box
HD-MB4	3-5/16"	5/16"	3/16"	22 lbs.	30/box
HD-MB6	5-7/8"	3/8"	1/4"	41 lbs.	20/box
HD-MB8	7-7/8"	3/8"	1/4"	52 lbs.	20/box



RAISED BASE PLATE

Item#	Size	Hole Dia.	Thickness	Wgt.	Pk
HD-FSH41	4"x4"x1"	7/16"	1/8"	56 lbs.	100/box
HD-FSH4112	4"x4"x1"-1/2"	7/16"	1/8"	52 lbs.	100/box
HD-FSH4114	4"x4"x1-1/4"	7/16"	1/8"	54 lbs.	100/box
HD-FSH42	5-1/4"x5-1/4"x2"	7/16"	1/8"	60 lbs.	50/box



STEEL DISC

Item#	Size (Dia.)	Thickness	Wgt	Pk
HD-SD112	1-1/2"	3.5 mm	35 lbs.	500/box
HD-SD158	1-5/8"	3.5 mm	41 lbs.	500/box
HD-SD178	1-7/8"	3.5 mm	48 lbs.	500/box
HD-SD335	3"	3.5 mm	55 lbs.	200/box
HD-SD36	3"	6.0 mm	48 lbs.	100/box

METAL STAMPING

STAIR & RAIL BRACKETS



HANDRAIL BRACKET

Item	HD-BH302	HD-BH250R	HD-BH250
Fit	Flat	Round	Flat
H	3-1/4"	3"	3"
W	2"	2"	2"
Gauge	10	10	10
Clearance	3"	2-1/2"	2-1/2"
Pk	100	100	100
Wgt	34 lbs.	34 lbs.	34 lbs.



HANDRAIL BRACKET

Item	HD-BH300	HD-BH300R
Fit	Flat	Round
H	3-1/4"	3-1/4"
W	2-3/4"	2-3/4"
Gauge	8	8
Clearance	3"	3"
Pk	100	100
Wgt	52 lbs.	52 lbs.



HANDRAIL BRACKET

Item	HD-BH212	HD-BH212R
Fit	Flat	Round
H	3-1/4"	3-1/4"
W	2-3/4"	2-3/4"
Gauge	8	8
Clearance	2-1/2"	2-1/2"
Pk	100	100
Wgt	52 lbs.	52 lbs.

METAL RINGS



STEEL TUBING RING - 1/2" SQUARE TUBING

Item#	Size (dia.)	Gauge	Wgt	Pk
HD-TR314	3-1/4"	18	20 lbs.	100/box
HD-TR315	3-1/2"	18	22 lbs.	100/box
HD-TR4	4"	18	24 lbs.	100/box
HD-TR414	4-1/4"	18	25 lbs.	80/box
HD-TR412	4-1/2"	18	22 lbs.	80/box
HD-TR5	5"	18	26 lbs.	80/box
HD-TR514	5-1/4"	18	17 lbs.	50/box
HD-TR512	5-1/2"	18	18 lbs.	50/box
HD-TR6	6"	18	20 lbs.	50/box
HD-TR7	7"	18	15 lbs.	30/box
HD-TR8	8"	18	17 lbs.	30/box
HD-TR10	10"	18	14 lbs.	20/box

STEEL TUBING RING - 1/2" ROUND TUBING

Item#	Size (dia.)	Wgt	Gauge	Pk
HD-TRR312	3-1/2"	17 lbs.	16	100/box
HD-TRR4	4"	20 lbs.	16	100/box



STEEL TAILED RING

Item#	Size	Mtl.	Wgt	Pk
IND-63102	3-15/16"	1/2"x1/4"	44 lbs.	80pc
IND-63104	4-11/16"	1/2"x1/4"	55 lbs.	100pc



SCROLLED STEEL RING

Item#	Size	Mtl.	Wgt.	Pk
IND-63001	4"	1/2"x1/4"	40 lbs.	120/box
IND-63006	4-1/2"	1/2"x1/4"	36 lbs.	90/box
IND-63008	5"	1/2"x1/4"	32 lbs.	70/box
IND-63201	4"	1/2"x1/2"	55 lbs.	100/box

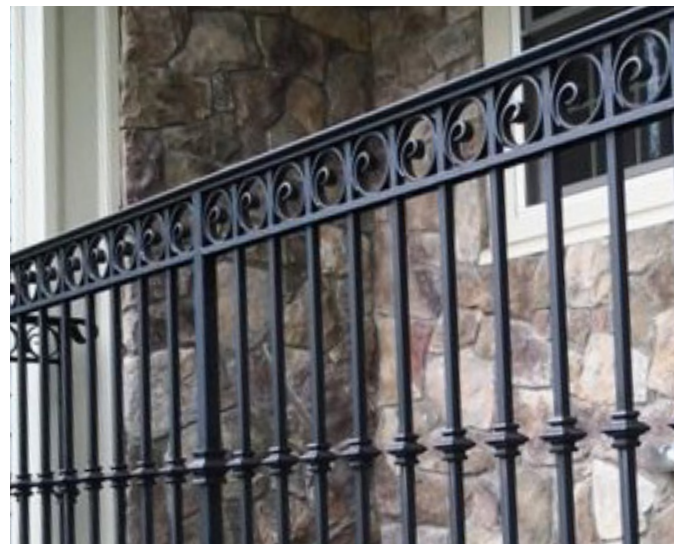

63102 depicted

PRESSED STEEL CAPS & SPHERES



STEEL HALF SPHERE - 16 GAUGE

Item	Size	Wgt	Pk
HD-BSH112	1-1/2"	12 lbs.	200/box
HD-BSH2	2"	19 lbs.	100/box
HD-BSH212	2-1/2"	17 lbs.	50/box
HD-BSH3	3"	11 lbs.	40/box
HD-BSH4	4"	12 lbs.	24/box
HD-BSH5	5"	15 lbs.	12/box
HD-BSH6	6"	13 lbs.	12/box
HD-BSH8	8"	16 lbs.	8/box
HD-BSH12	12"	18 lbs.	6/box



HOLLOW STEEL BALL - 16 GAUGE

Item	Size	Wgt	Pk
HD-BS112	1-1/2"	11 lbs.	100/box
HD-BS2	2"	12 lbs.	50/box
HD-BS212	2-1/2"	19 lbs.	50/box
HD-BS3	3"	11 lbs.	20/box
HD-BS4	4"	12 lbs.	12/box
HD-BS5	5"	10 lbs.	6/box
HD-BS6	6"	13 lbs.	6/box
HD-BS8	8"	16 lbs.	4/box
HD-BS12	12"	18 lbs.	2/box



PRESSED STEEL POST CAP

Item	Size	Wgt	Pk
HD-CS34	3/4"	10 lbs.	500/box
HD-CS1	1"	16 lbs.	500/box
HD-CS114	1-1/4"	22 lbs.	500/box
HD-CS112	1-1/2"	25 lbs.	400/box
HD-CS2	2"	40 lbs.	400/box
HD-CS212	2-1/2"	35 lbs.	200/box
HD-CS3	3"	43 lbs.	200/box
HD-CS312	3-1/2"	27 lbs.	150/box
HD-CS4	4"	33 lbs.	100/box
HD-CS5	5"	45 lbs.	100/box
HD-CS6	6"	33 lbs.	50/box
HD-CS8	8"	9 lbs.	6/box

WELD ON FITTINGS



90 DEGREE STEEL WELD-ON PIPE ELBOWS (SCH 40)

Item#	Size (IDia.)	Inside Radius	Wgt	Pk
FIT-E9010	1"	0.8"	34 lbs.	100/box
FIT-E9014	1-1/4"	1.10"	28 lbs.	50/box
FIT-E9012	1-1/2"	1.35"	31 lbs.	40/box
FIT-E9020	2"	1.80"	28 lbs.	20/box
FIT-E9030	3"	2.75"	46 lbs.	10/box
FIT-E9040	4"	3.75"	35 lbs.	4/box



45 DEGREE STEEL WELD-ON PIPE ELBOWS (SCH 40)

Item#	Size (Dia.)	Inside Radius	Wgt	Pk
FIT-E4514	1-1/4"	1.10"	15 lbs.	50/box
FIT-E4512	1-1/2"	1.35"	15 lbs.	40/box
FIT-E4520	2"	1.80"	13 lbs.	20/box
FIT-E4530	3"	2.75"	2.5 lbs.	Each
FIT-E4540	4"	3.75"	4.0 lbs.	Each



STEEL WELD-ON PIPE END-CAPS (SCH 40)

Item#	Size (Dia.)	Wgt	Pk
FIT-EC10	1"	12 lbs.	100/box
FIT-EC114	1-1/4"	13 lbs.	50/box
FIT-EC112	1-1/2"	14 lbs.	50/box
FIT-EC20	2"	17 lbs.	40/box
FIT-EC30	3"	12 lbs.	10/box
FIT-EC40	4"	12 lbs.	6/box

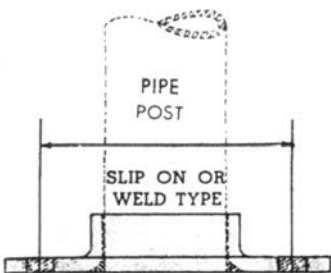

RAISED STEEL PIPE FLANGE - NO HOLE (SCH 40)

Item#	Fit	I.D.	O.D.	Flange Dia.	Wgt	Pk
HD-FRH114NH	1-1/4"	1-5/8"	1-7/8"	3-3/4"	40 lbs.	100/box
HD-FRH112NH	1-1/2"	1-7/8"	2-1/8"	4-1/4"	50 lbs.	100/box
HD-FRH200NH	2"	2-3/8"	2-9/16"	4-3/4"	31 lbs.	50/box



RAISED STEEL PIPE FLANGE W/ HOLES (SCH 40)

Item#	Fit	I.D.	O.D.	Flange Dia.	Wgt	Pk
HD-FRH114	1-1/4"	1-5/8"	1-7/8"	3-3/4"	40 lbs.	100/box
HD-FRH112	1-1/2"	1-7/8"	2-1/8"	4-1/4"	50 lbs.	100/box
HD-FRH200	2"	2-3/8"	2-9/16"	4-3/4"	31 lbs.	50/box

PLASTIC CAPS



SQUARE PLASTIC CAPS (BLACK/WHITE)

Item	Size	Pc/Box	Weight
PLS-CAP12	1/2" x 1/2"	5000	10 lbs.
PLS-CAP58	5/8" x 5/8"	5000	18 lbs.
PLS-CAP34	3/4" x 3/4"	3000	14 lbs.
PLS-CAP1	1" x 1"	1000	10 lbs.
PLS-CAP114	1-1/4" x 1-1/4"	1000	11 lbs.
PLS-CAP112	1-1/2" x 1-1/2"	1000	15 lbs.
PLS-CAP2	2" x 2"	400	10 lbs.
PLS-CAP3	3" x 3"	200	12 lbs.
PLS-CAP34X112	3/4" x 1-1/2"	1000	11 lbs.
PLS-CAP1X112	1" x 1-1/2"	1000	12 lbs.
PLS-CAP1X2	1" x 2"	1000	14 lbs.



ROUND PLASTIC CAPS (BLACK/WHITE)

Item	Size (Dia.)	Pk	Wgt
PLS-CAPR12	1/2"	5000	10 lbs.
PLS-CAPR58	5/8"	5000	18 lbs.
PLS-CAPR34	3/4"	3000	14 lbs.
PLS-CAPR1	1"	1000	10 lbs.
PLS-CAPR114	1-1/4"	1000	11 lbs.
PLS-CAPR112	1-1/2"	1000	15 lbs.
PLS-CAPR2	2"	400	10 lbs.
PLS-CAPR3	3"	200	12 lbs.

PLASTIC SPEAR



PLS-P217B

Available in 1/2" 5/8", 3/4"
Packed 400 pcs/box
H: 4" W: 1"

Weight: 16 lbs
* Black finish only



PLASTIC SPEAR

PLS-P227B

Available in 1/2" 5/8", 3/4"
Packed 400 pcs/box
Weight: 16 lbs
H: 4" W: 2-1/2"
* Black finish only



PLASTIC SPEAR

PLS-P215

Available in 1/2" 5/8", 3/4"
Packed 400 pcs/box
Weight: 16 lbs
H: 4" W: 2-1/4"
* Black finish only

HARDWARE - LOCKSETS

MORTISE LOCKSET w/ LEVER

Packed 12 pcs/box 60 lbs./box

- Solid Brass Decorative Trim
- Solid Brass Decorative Lever w/Rosette
- Mortise Lock w/ 1" Deadbolt
- Double solid Brass Cylinders
- Kwikset Keyway **Keyed Alike 6**
- Night Latch

LCK-MLH113 (Polished Brass)

LCK-MLH115 (Antique Brass)

LCK-MLH1126D (Satin Chrome)

LCK-MLH111P (Oil Rubbed Bronze)



MORTISE LOCKSET w/ KNOB

Packed 12 pcs/box 53 lbs./box

- Solid Brass Decorative Trim
- Brass Decorative Round Knob w/Rosette
- Mortise Lock w/ 1" Deadbolt
- Double solid Brass Cylinders
- Kwikset Keyway **Keyed Alike 6**
- Night Latch

LCK-MLK403 (Polished Brass)

LCK-MLK405 (Antique Brass)

LCK-MLK4026D (Satin Chrome)

LCK-MLK411P (Oil Rubbed Bronze)



MORTISE LOCKSET w/ LEVER

Packed 12 pcs/box 61 lbs./box

- Solid Brass Decorative Trim
- Modern Lever Handle
- Mortise Lock w/ 1" Deadbolt
- Double solid Brass Cylinders
- Kwikset Keyway **Keyed Alike 6**
- Night Latch

LCK-MLH223 (Polished Brass)

LCK-MLH235 (Antique Brass)



HARDWARE - LOCKSETS

MORTISE LOCKSET w/KNOB

Packed 12 pcs/box
44 lbs/ box

- Solid Brass Round Knob w/ Rosette
- Mortise lock with 1" Deadbolt
- Night latch
- Kwikset Keyway **KA-6**

LCK-MLK223 - Polished Brass
LCK-MLK225 - Antique Brass
LCK-MLK2226D - Satin Chrome
LCK-MLK211P - Oil rubbed bronze

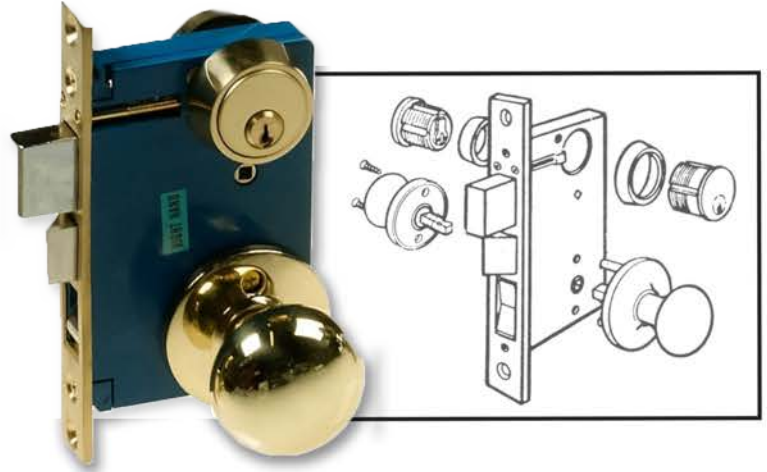

ACCESSORIES AND PARTS

Items below available in different finishes

LPT-LH9370	Lever handle - Left or Right facing
LPT-MK9830	Mushroom knob
LPT-TCY9385	Thumbturn cylinder
LPT-CY9380	Keyed cylinder- available with Kwikset OR Schlage keyways
LPT-K9242	Replacement knob set
LPT-MLBTT	Brass thumbturn
LPT-BPH9355	Brass Plate- L: 2-3/4" x W: 2"
LPT-MLLB9300	Lockbody Acc. (Right or Left)
LPT-RCY9252	Replacement exterior cylinder ring
LPT-BPH9355	Trim plate

Knobs, trim plates, lock bodies, lever handles, and thumbturns are available in several finishes and can be ordered separately.

LCK-SLH556 SLIMLINE MORTISE LOCKSET

- Designed to interchange with the same lock components as our original SLH-516 lock.
- Improved true 1" deadbolt and latch bolt that retracts with key operation and handle.
- Solid brass rekeyable Kwikset cylinders.
- Available with double-keyed cylinders and single cylinder thumb-turns and four finishes: polished brass, satin chrome, oil-rubbed bronze, and antique brass.
- Easier installation with the CEL-LG-S9 (9.5" lockguard)

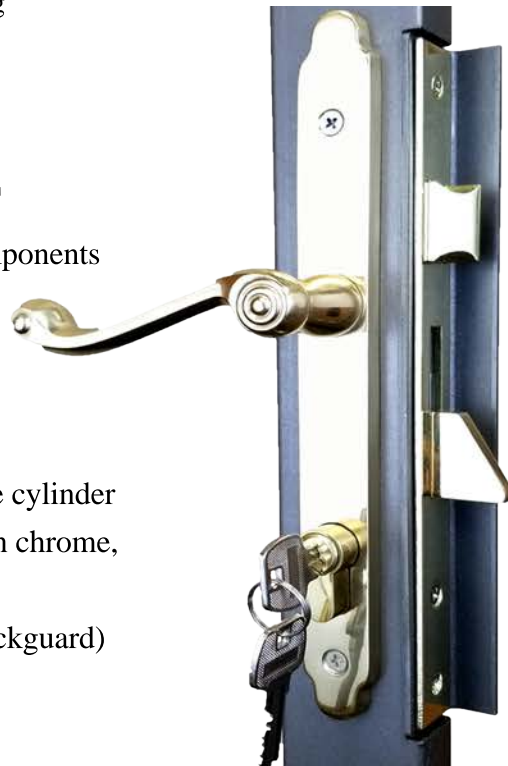

HARDWARE - LOCKSETS

SLIM-LINE MORTISE LOCKSET

Packed 12 pcs/box
42 lbs/ box

- Solid Brass Decorative Lever w/ Trim
- Mortise lock with 1" Deadbolt
- Double Solid Brass Rekeyable Cylinders
- Kwikset Keyway **KA-12**

1" DEADBOLT

- LCK-SLH5563** - Polished brass
- LCK-SLH5565** - Antique brass
- LCK-SLH55626D** - Satin chrome
- LCK-SLH55610B** - Oil rubbed bronze

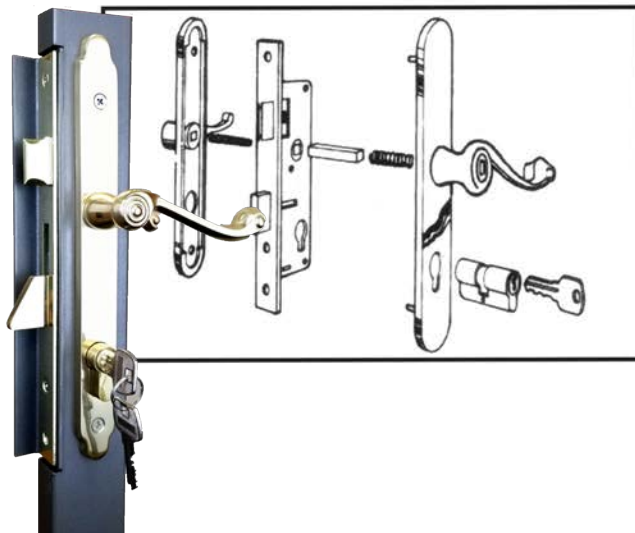

SLIM-LINE MORTISE LOCKSET

Packed 24 pcs/box
45 lbs/box

- Solid Brass Trim w/ Die Cast Handle
- Mortise lock with 5/8" Deadbolt
- Double Solid Brass Rekeyable Cylinders
- Kwikset Keyway **KA-12**

- LPT-SLB9600** - Lockbody available
- LCK-SLH2003** - Polished Brass
- LCK-SLH20026D** - Satin Chrome

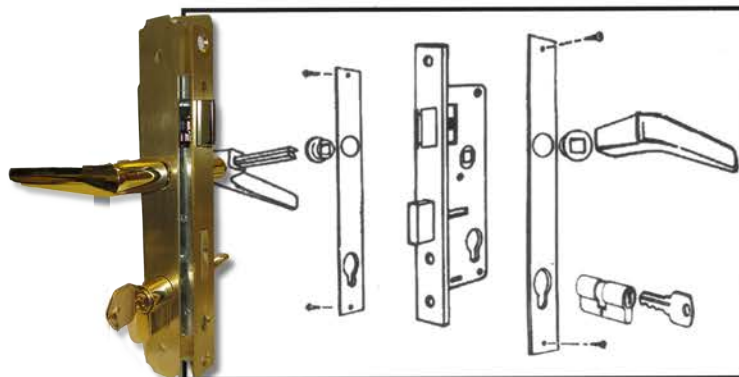

SLIM-LINE MORTISE LOCKSET

Packed 24 pcs/box
69 lbs/box

- Solid Brass Trim w/ Handle
- Mortise lock with 5/8" Deadbolt
- Double Solid Brass Rekeyable Cylinders
- Kwikset Keyway **KA-12**

- LCK-SLH536200** - Polished Brass
- LCK-SLH53626D** - Satin Chrome
- LCK-SLH53610B** - Oil Rubbed Bronze

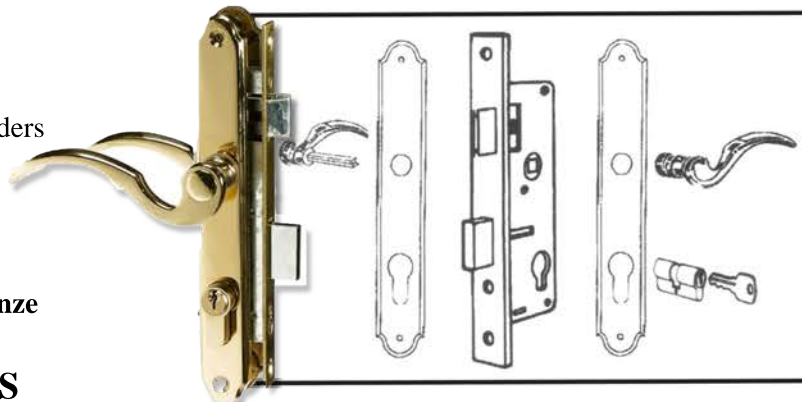

ACCESSORIES AND PARTS

- LPT-SCY9680** Double Cylinder
- LPT-SDT9635** Dummy Trim and Lever
- LPT-TSCY9685** Cylinder and Thumbturn

Lever trim set, mortise lock body, cylinders, and key blanks can be ordered separately.

HARDWARE - LOCKSETS

EZSET LEVER HANDLES

Packed 20 pcs/box

31 lbs/box

2-3/8" Backset

LCK-EZLHK3 - Polished Brass

LCK-EZLHK5 - Antique Brass

LCK-EZLHK32D - Satin Chrome



LCK-EZLHK5 shown.

EZSET KEYED ENTRY

Packed 20 pcs/box

36 lbs/box

2-3/8" Backset

LCK-EZLHK363 - Polished Brass

LCK-EZLHK365 - Antique Brass



LCK-EZLHM3 shown.

EZSET LEVER DOUBLE CYLINDER COMBINATIONS

Packed 10 pcs/box

31 lbs/box

LCK-EZDTLK-363 - Polished Brass
(EZLHK363/T6333)

LCK-EZDTLK-365 - Antique Brass
(EZLHK365/T63335)

LCK-EZDTLK-3632D - Satin Chrome
(EZLHK3632D/T63332D)



LCK-EZDTLK-363 shown.

CEL LEVER HANDLES

Packed 24 pcs/box

29 lbs/box

2-3/8" Backset

LCK-LHM3 - Polished Brass

LCK-LHM5 - Antique Brass

LCK-KK9301 "EZ" Set Keying Kit

LPT-GL3 - Polished Brass

LPT-GL5 - Antique Brass

LPT-GL26D - Satin Chrome

CEL KEYED LEVER ENTRY

Packed 24 pcs/box

36 lbs/box

2-3/8" Backset

LCK-LHM363 - Polished Brass

LCK-LHM365 - Antique Brass

SPRING LATCH ONLY

2-3/8" Backset

Packed 12 pcs/box

4 lbs/box



HARDWARE - LOCKSETS

EZSET SINGLE CYLINDER DEADBOLT

Packed 20 pcs/box
32 lbs/box
KA-10



LCK-EZS1113 - Polished Brass
LCK-EZS1115 - Antique Brass
LCK-EZS11132D - Satin Chrome
LCK-EZS11110B - Oil Rubbed Bronze



EZSET DOUBLE CYLINDER DEAD- BOLT

Packed 20 pcs/box
32 lbs/box
KA-10



LCK-EZD2113 - Polished Brass
LCK-EZD2115 - Antique Brass
LCK-EZD21132D - Satin Chrome
LCK-EZD21110B - Oil Rubbed Bronze



EZ-DT shown in Antique Brass finish.

Passage

20 pcs/box
26 lbs./box

LCK-EZT6113 - Polished brass
LCK-EZT6115 - Antique Brass
LCK-EZT61132D - Satin Chrome

Keyed Entry

20 pcs/box
29 lbs/box
KA-10

LCK-EZT6333 - Polished Brass
LCK-EZT6335 - Antique Brass
LCK-EZT63332D - Satin Chrome
LCK-EZT63310B - Oil Rubbed Bronze

Single Cylinder Storeroom-

20 pcs/box
29 lbs/box
KA-10 (only keyed on one side)
LCK-EZT6453 - Polished Brass

LCK-EZST3 Single Cylinder Combo

(S1113/T6333) Polished Brass

LCK-EZST5 Single Cylinder Combo

(S1115/T6335) Antique Brass

LCK-EZST32D Single Cylinder Combo

Satin Chrome Finish

LCK-EZST10B Single Cylinder Combo

Oil Rubbed Bronze

EZ-SET Combination locksets are packed 10

sets/box and keyed alike. 30 lbs per box.

LCK-EZDT3 Double Cylinder Combo

(D2113/T6333) Polished Brass

EZ-DT5 Double Cylinder Combo

(D2115/T6335) Antique Brass

EZ-DT32D Double Cylinder Combo

Satin Chrome Finish

EZ-DT10B Double Cylinder Combo

Oil Rubbed Bronze

HARDWARE - LOCKSETS

CEL DOUBLE/SINGLE CYLINDER DOOR LOCKS

DC- DOUBLE CYLINDER/ SC- SINGLE CYLINDER

Item#	Finish	Screws	KA	Wgt.	PCS./box
LCK-DC3	PB	Concealed	12	37 lbs.	24/box
LCK-DC5	AB	Concealed	12	37 lbs.	24/box
LCK-DC32D	SC	Concealed	12	37 lbs.	24/box
LCK-SC3	PB		12	26 lbs.	24/box
LCK-SC5	AB		12	26 lbs.	24/box
LCK-SC32D	SC		12	26 lbs.	24/box



Shown: LCK-DC3- Available with thumbturn

LCK-SC / LCK-DC

CEL LOCK CYLINDER W/SPRING LATCH

Latch Springs back and Locks Automatically when Key is removed from Cylinder on either side. Provides convenience and security for wood and steel gates.

2-3/8" Backset
Packed 24/box
31 lbs/box

Single Cylinder - Also available w/ Schlage keyway

LCK-SC3 - Polished Brass

LCK-SC5 - Antique Brass

LCK-SC32D - Satin Chrome

Available w/Latch: SC3L / SC5L / SC32DL

Double Cylinder

LCK-DC3L - Polished Brass

LCK-DC5L - Antique Brass



Shown: LCK-DC3L- Available with thumbturn

LCK-LSIPBD / LSIPBS

SNAP-IN DEAD BOLT LOCK

LCK-LSIPD- Double Cylinder Keyed both sides

LCK-LSIPBS- Single Cylinder w/Thumbturn

Keyed Alike in 12
Packed 24 pcs/box
40 lbs/box

For use in 1" x 3" Steel Tubing
Concealed mounting screw
Fits Flush into Tubing
Lock Box Optional



HARDWARE - LOCKSETS

HOOKLOCKS

1-1/8" Backset
Black P/C Lockbox
Kwikset Keyway
Inc. 2 Keys

LCK-18200 - Double Cylinder

LCK-18200S - Single Cylinder
Available in Right/Left

LCK-18500 - Straight Bolt

LCK-45100 - Spring Latch
Available in Right/Left

Packed 12 pcs/box
38 lbs/box

18200



With Double Cylinder

18500



With Swing Up
Straight Bolt

45100



With Reversible
Spring Latch

DIGITAL PUSH BUTTON DOOR LOCK

LCK-NK4000LXL (Left)

LCK-NK4000LXR (Right)

LCK-NK4000SDL (Double Left)

LCK-NK4000SDR (Double Right)

Oil Rubbed Bronze Finish

Satin Chrome Finish

Lockbox width: 1-1/4"

Sold each

6 lbs/each

- All-mechanical actions
- Over 5,000 possible code combinations
- Codes can be changed
- Can be used for left or right-handed doors
- Over 100,000 operations tested
- Can be used with or without included lockbox



HARDWARE - LOCK BOXES

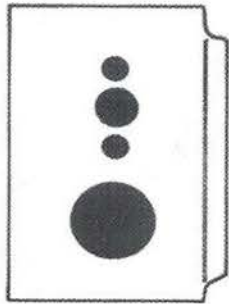

15-605L - Left

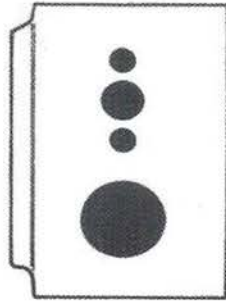

15-605R - Right

MORTISE LOCKBOX (14 GAUGE)

Item#	Size	Hinge Side	Pk	Wgt.
LCK-15-605L	1"x4"x7-1/4"	Left	20	40 lbs.
LCK-15-605R	1"x4"x7-1/4"	Right	20	40 lbs.

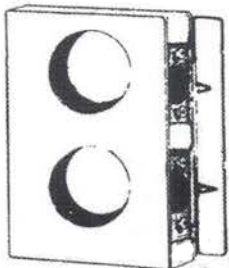

Shown: 15-276

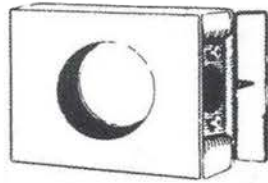

Shown: 15-176

LOCKBOX W/ FLAT BOLT GUARD

Item#	Backset	Width	Hole Dia.	Pk	Wgt.
LCK-15-176	2-3/8"	1-1/4"	2-1/8"	40	40 lbs.
LCK-15-276	2-3/8"	1-1/4"	Dbl 2-1/8"	20	40 lbs.

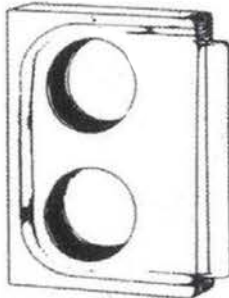

Shown: 15-250R

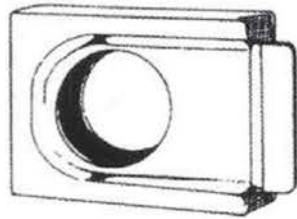

Shown: 15-150R

LOCKBOX W/ STRAIGHT BOLT GUARD

Item#	Backset	Width	Hole Dia.	Pk	Wgt.
LCK-15-150S	2-3/8"	1"	2-1/8"	40	37 lbs.
LCK-15-250S	2-3/8"	1"	Dbl 2-1/8"	20	40 lbs.

LOCKBOX W/ BENT BOLT GUARD

Item#	Backset	Width	Hole Dia.	Pk	Wgt.
LCK-15-150R	2-3/8"	1"	2-1/8"	40	37 lbs.
LCK-15-250R	2-3/8"	1"	Dbl 2-1/8"	20	40 lbs.

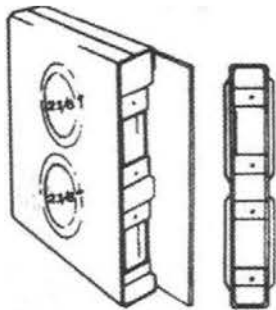

Shown: 15-225

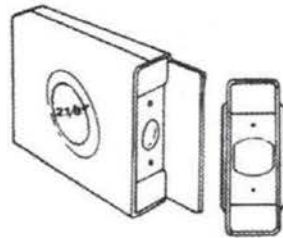

Shown: 15-125

BUBBLE LOCKBOX W/ BOLT GUARD

Item#	Backset	Width	Hole Dia.	Pk	Wgt.
LCK-15-125	2-3/8"	1-1/4"	2-1/8"	40	40 lbs.
LCK-15-225	2-3/8"	1-1/4"	Dbl 2-1/8"	20	40 lbs.
LCK-15-225NG*	2-3/8"	1-1/4"	Dbl 2-1/8"	20	38 lbs.

* NG - No Bolt Guard

HARDWARE - LOCK BOXES

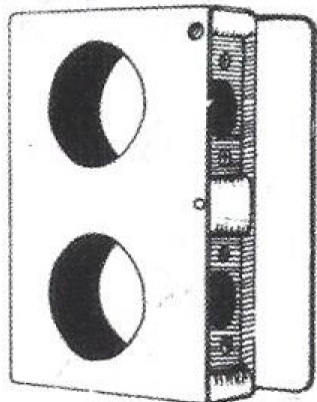

Shown: 13-205

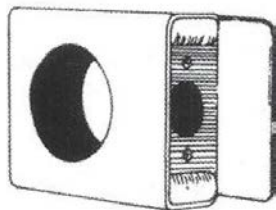

Shown: 13-105

LOCK BOX (W/BOLT GUARD)

Item	Backset	Hole	W	Pk	Wgt.
LCK-13-105	2-3/8"	Sgl 2-1/8"	1-5/8"	40	40 lbs.
LCK-13-205	2-3/8"	Db1 2-1/8"	1-5/8"	20	35 lbs.
LCK-13-115	2-3/8"	Sgl 2-1/8"	1-1/2"	40	40 lbs.
LCK-13-215	2-3/8"	Db1 2-1/8"	1-1/2"	20	35 lbs.
LCK-13-134	2-3/4"	Sgl 2-1/8"	1-1/2"	40	40 lbs.
LCK-A13-115	2-3/8"	Sgl 2-1/8"	1-1/2"	40	40 lbs.
LCK-A13-215	2-3/8"	Db1 2-1/8"	1-1/2"	20	35 lbs.
LCK-13-140	2-3/8"	Sgl 2-1/8"	2"	40	40 lbs.
LCK-13-240	2-3/8"	Db1 2-1/8"	2"	20	40 lbs.

A - Aluminum



Shown: 13-240 (2" wide steel lockbox)

While most hardware will adjust anywhere between 1-3/4" to 2", it's good practice to measure the thickness of your door before ordering hardware.

HARDWARE - DOOR



13-MS-CS mail slot and LA-190S casting depicted.

LETTER SLOT SET

HD-10LSCS
Letter Slot Complete Set

Available in: Polished Brass,
Antique Brass, Satin Chrome,
and Oil-rubbed Bronze

Measures 10" x 3-1/8"
Packed 20 pcs/box
24 lbs/box

LETTER SLOT - FRONT

HD-10LSF
Letter Slot Front Only

Available in: Polished Brass,
Antique Brass, Satin Chrome,
and Oil-rubbed Bronze

Measures 10" x 3-1/8"
Packed 40 pcs/box
28 lbs/box

MAGAZINE SLOT SET

HD-13MSCS
Magazine Slot Complete Set

Available in: Polished Brass,
Antique Brass, Satin Chrome,
and Oil-rubbed Bronze

Measures 13" x 3-5/8"
Packed 20 pcs/box
40 lbs/box

MAGAZINE SLOT - FRONT

HD-13MSF
Magazine Slot Front Only

Available in: Polished Brass,
Antique Brass, Satin Chrome, and
Oil-rubbed Bronze

Measures 13-1/8" x 3-5/8"
Packed 40 pcs/box
44 lbs/box

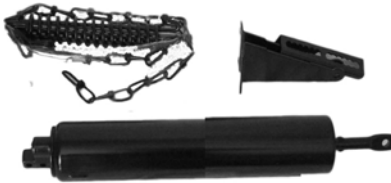

DOOR CLOSER SET

HD-VDC107 (Black)
HD-VDC107W (White)
Door Closer w/Storm Chain (1601)
Tube Dia.: 1-1/2"
Packed 20 pcs/box
35 lbs/box

HD-DC1107 (Black)
HD-DC1107W (White)
Door Closer Only
Packed 20 pcs/box
30 lbs/box



HD DOOR CLOSER

HD-DC1108 (Black)
HD-DC1108W (White)

Heavy Duty Door Closer
Tube Dia.: 1-1/2"
W/ Torsion Bar available
Packed 20 pcs/box
35 lbs/box



DOOR CHAIN

HD-DC1601B (Black)
HD-DC1601 (Zinc)

Measures 13" x 3-5/8"
Packed 120 pcs/box
46 lbs/box

HEAVY DUTY GATE CLOSER

HD-GC2000

- Easy Installation, compact and durable.
- Over 100,000 operations tested.
- 90 degree hold open function.
- Two-speed closing
- Suitable for indoor or outdoor installation
- Designed specifically for use on Metal Gates, can also be used on wooden doors.
- Weight limit per closer up to 120 lbs.

Packed 12 pc/box
Weight: 29 lbs/bx

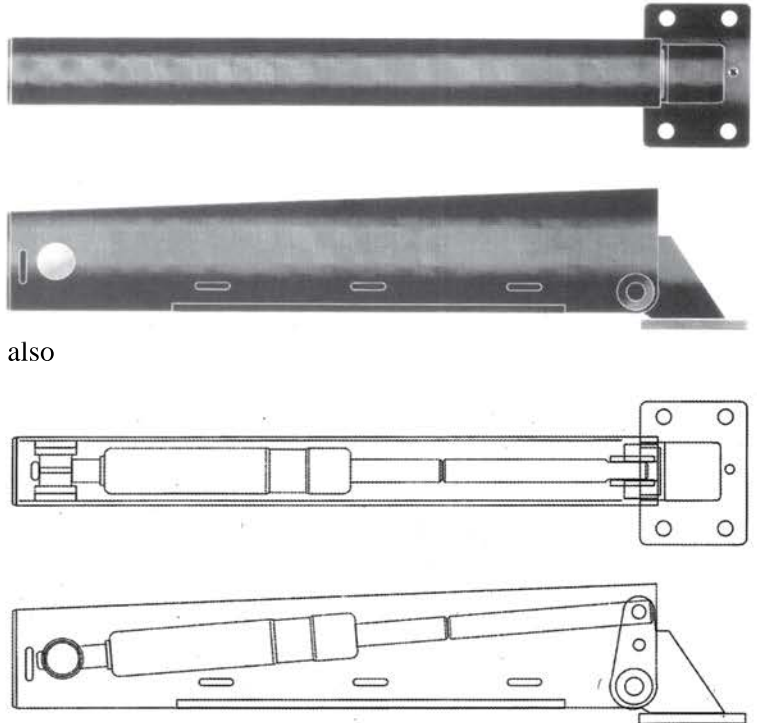

HD-GC3000

- Self-closing hydraulic-action gate closer.
- Closes up to 125 lbs gently and smoothly.
- Adjustable hydraulic action provides reliable and ample closing force.
- Rugged design can be used indoors or outdoors.
- Quality hydraulic cylinder guarantees exceptional reliability.

Packed 8pc/box
Weight: 42 lbs/box



HARDWARE - WINDOW

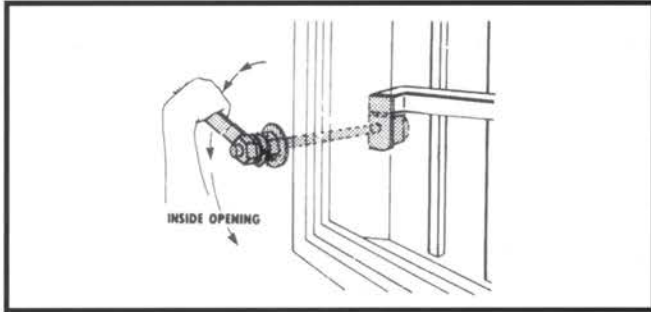

WINDOW GUARD FIRE RELEASE

HD-WGFR7R (7")
HD-WGFR9R (9")
HD-WGFR11R (11")

- Lever operated.
- 1/2" Hole through wall required for installation.
- Complete with "D" shaft/hole handle.
- Spring loaded. (Spring retained in cylinder head)
- Easily adjustable for wall thicknesses

Packed 80 pcs/box

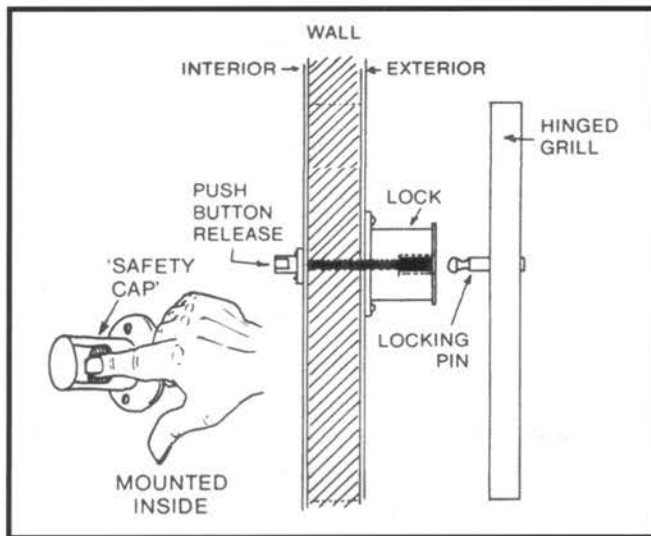

DELUXE PUSH BUTTON RELEASE

HD-WGFRPBD

- Convenient push button window guard fire release.

Packed 20 sets/box

Weight 37 lbs/box



CEL TUBE BENDER



TUBE BENDER

HD-TOTB

- 1-1/8" Heavy duty adjustment Rod
- Square tubing guiding gear (STG101)
- Heavy duty pillow block axle
- Removable crank handle
- Components made of 1018 cold rolled steel heat treated for durability and strength
- Capacity: Flat/Recatangular tubing 1/2" to 2"

Packed each

48 lbs/each

CAST IRON SPEARS



ORI-215					
Sz	H	W	Base	Wgt	Pk
1/2"	4-1/4"	3"	1"	18 lbs.	50
5/8"	4-1/4"	3"	1-1/8"	18 lbs.	50
3/4"	4-1/8"	3-1/8"	1-1/8"	18 lbs.	50

ORI-S215 - ECONOLINE					
Sz	H	W	Base	Wgt	Pk
1/2"	4"	2"	3/4"	12 lbs.	50
5/8"	4"	2"	3/4"	12 lbs.	50
3/4"	4"	2"	7/8"	12 lbs.	50



ORI-227					
Sz	H	W	Base	Wgt	Pk
1/2"	4-1/4"	3"	1"	18 lbs.	50
5/8"	4-1/4"	3"	1-1/8"	18 lbs.	50
3/4"	4-1/8"	3-1/8"	1-1/8"	18 lbs.	50

ORI-S227 - ECONOLINE					
Sz	H	W	Base	Wgt	Pk
1/2"	4-3/4"	2-7/8"	1-1/8"	17 lbs.	50
5/8"	4-3/4"	2-7/8"	1-1/8"	17 lbs.	50
3/4"	4-3/4"	3"	1-1/8"	19 lbs.	50



ORI-217					
Sz	H	W	Base	Wgt	Pk
1/2"	4-1/8"	1-1/8"	1"	19 lbs.	70
5/8"	4-1/8"	1-1/8"	1"	20 lbs.	70
3/4"	4-1/8"	1-1/8"	1-1/8"	20 lbs.	70

ORI-S217 - ECONOLINE					
Sz	H	W	Base	Wgt	Pk
1/2"	4"	7/8"	15/16"	17 lbs.	70
5/8"	4"	7/8"	15/16"	17 lbs.	70
3/4"	4"	7/8"	15/16"	17 lbs.	70



ORI-260					
Sz	H	W	Base	Wgt	Pk
1/2"	5-1/4"	3-1/4"	3/4"	16 lbs.	30
5/8"	5-1/4"	3-1/4"	1"	16 lbs.	30
3/4"	5-1/2"	3-1/4"	1"	16 lbs.	30

ORI-S260 - ECONOLINE					
Sz	H	W	Base	Wgt	Pk
1/2"	4-3/4"	3-1/8"	7/8"	15 lbs.	45
5/8"	4-3/4"	3-1/4"	7/8"	15 lbs.	30
3/4"	4-3/4"	3-1/4"	7/8"	15 lbs.	30



ORI-217B					
Sz	H	W	Base	Wgt	Pk
1/2"	4-1/8"	1-1/8"	1"	19 lbs.	70
5/8"	4-1/8"	1-1/8"	1"	19 lbs.	70
3/4"	4-1/8"	1-1/8"	1-1/8"	20 lbs.	70

ORI-S217B - ECONOLINE					
Sz	H	W	Base	Wgt	Pk
1/2"	4"	7/8"	15/16"	16 lbs.	70
5/8"	4"	7/8"	15/16"	16 lbs.	70
3/4"	4"	7/8"	15/16"	16 lbs.	70



ORI-251					
Sz	H	W	Base	Wgt	Pk
1/2"	1-7/8"	1-1/8"	1"	18 lbs.	55
5/8"	1-3/4"	1-5/8"	1"	19 lbs.	48
3/4"	2-1/8"	2-1/8"	1-1/8"	18 lbs.	32
1"	2-3/8"	2-5/8"	1-1/8"	18 lbs.	22

ORI-S251 - ECONOLINE					
Sz	H	W	Base	Wgt	Pk
1/2"	1-13/16"	1-1/2"	1"	13 lbs.	55
5/8"	1-13/16"	1-3/4"	1"	13 lbs.	48
3/4"	1-7/8"	2"	1"	12 lbs.	32
1"	2-1/4"	2-1/2"	1"	28 lbs.	56



ORI-218					
Sz	H	W	Base	Wgt	Pk
1/2"	4"	2-1/4"	1"	16 lbs.	50
5/8"	4"	2-1/4"	1"	16 lbs.	50
3/4"	4"	2-1/4"	1"	16 lbs.	50

ORI-S218 - ECONOLINE					
Sz	H	W	Base	Wgt	Pk
1/2"	3-7/8"	2-1/8"	1-1/8"	12 lbs.	50
5/8"	3-7/8"	2-1/8"	1-1/8"	13 lbs.	50
3/4"	3-7/8"	2-1/2"	1-1/8"	13 lbs.	50

CAST IRON SPEARS



ORI-270			
Sz	1/2"	5/8"	3/4"
H	5-5/8"	5-5/8"	5-5/8"
W	2-1/2"	2-1/2"	2-1/2"
Base	1"	1-3/16"	1-3/8"
Wgt	22 lbs.	22 lbs.	22 lbs.
Pk	30	30	25



ORI-L659 (SQUARE FIT)			
Item#	L659H	L659Y	L659Z
Sz	5/8"	3/4"	1"
H	5-3/8"	6-3/4"	6"
W	3-1/2"	4-1/8"	4"
Base	1-1/16"	1-1/4"	1-1/2"
Wgt	34 lbs.	23 lbs.	25 lbs.
Pk	40	25	25



ORI-655			
Item#	655	655H	655Y
Sz	1/2"	5/8"	3/4"
H	6"	6"	6-1/2"
W	3-1/8"	3-1/8"	3-1/2"
Base	1-1/2"	1-5/8"	1-3/4"
Wgt	20 lbs.	20 lbs.	20 lbs.
Pk	15	15	15



ORI-6914 (ROUND FIT)	
Sz	1/2"
H	4"
W	1-3/4"
Base	3/4" O.D.
Wgt	22 lbs.
Pk	70



ORI-9 (SQUARE FIT)		
Item#	9H	9Y
Sz	5/8"	3/4"
H	4-1/2"	5-3/4"
W	1-1/8"	1-3/4"
Base	1-3/16"	1-1/4"
Wgt	20 lbs.	23 lbs.
Pk	40	15



CL-668 (SQUARE FIT)			
Item#	668	668H	668Y
Sz	1/2"	5/8"	3/4"
H	7"	7"	7"
W	3"	3"	3-1/8"
Base	1"	1-1/8"	1-1/8"
Wgt	32 lbs.	32 lbs.	32 lbs.
Pk	40	40	40



ORI-L649 - (SQUARE FIT)			
Item#	L649H	L649Y	L649Z
Sz	5/8"	3/4"	1"
H	4-1/2"	5-1/4"	6-1/4"
W	2-1/4"	2-5/8"	6-1/4"
Base	1-1/8"	1-1/8"	1-3/4"
Wgt	19 lbs.	25 lbs.	16 lbs.
Pk	35	30	11



ORI-L656 - (SQUARE FIT)		
Item#	L656H	L656Y
Sz	5/8"	3/4"
H	5-5/8"	6-3/4"
W	3-1/2"	4-1/8"
Base	1-1/16"	1-1/4"
Wgt	22 lbs.	23 lbs.
Pk	25	20

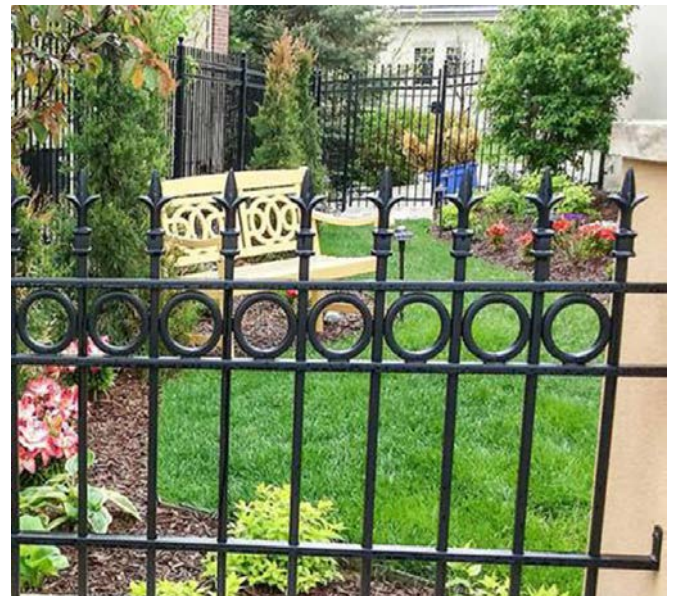

ORI-L649 shown.

CAST IRON SPEARS



CL-826 (SQUARE FIT)	
Sz	3/4"
H	7"
W	4"
Base	1-1/2"
Wgt	32 lbs.
Pk	30



CL-8832 shown.



CL-651 (ROUND FIT)	
Sz	1/2"
H	5-1/4"
W	4"
Base	1-1/8"
Wgt	40 lbs.
Pk	45



CL-831 (SQUARE FIT)			
Item#	831	831H	831Y
Sz	1/2"	5/8"	3/4"
H	5-3/8"	5-5/8"	5-5/8"
W	2-3/8"	2-3/8"	2-3/8"
Base	7/8"	1-1/4"	1-1/4"
Wgt	23 lbs.	24 lbs.	26 lbs.
Pk	40	40	40



CL-825 (SQUARE FIT)	
Sz	1/2"
H	4-3/4"
W	1-1/2"
Base	1-1/4" O.D.
Wgt	31 lbs.
Pk	65



CL-431 (SQUARE FIT)			
Item#	431	431H	431Y
Sz	1/2"	5/8"	3/4"
H	5-3/8"	5-5/8"	5-5/8"
W	2-3/8"	2-3/8"	2-3/8"
Base	1-1/4"	1-1/4"	1-1/4"
Wgt	24 lbs.	24 lbs.	24 lbs.
Pk	30	30	30



CL-9XS (SQUARE FIT)	
Sz	1/2"
H	3-1/2"
W	1"
Base	1"
Wgt	17 lbs.
Pk	50



CL-8832 (SQUARE FIT)			
Item#	8832	8832H	8832Y
Sz	1/2"	5/8"	3/4"
H	5-3/8"	5-5/8"	5-5/8"
W	2-3/8"	2-3/8"	2-3/8"
Base	1"	1-1/4"	1-1/4"
Wgt	24 lbs.	24 lbs.	24 lbs.
Pk	35	35	35



CL-7009 (SQUARE FIT)	
Sz	5/8"
H	5-3/4"
W	2-1/2"
Base	1-1/8"
Wgt	28 lbs.
Pk	30



CL-670 (SQUARE FIT)			
Item#	670	670H	670Y
Sz	1/2"	5/8"	3/4"
H	5-3/4"	5-5/8"	5-3/4"
W	3-5/8"	3-5/8"	3-5/8"
Base	1-1/8"	1-1/8"	1-1/8"
Wgt	20 lbs.	20 lbs.	20 lbs.
Pk	30	35	35

CAST IRON SPEARS



CL-8812 (SQUARE FIT)

Item#	8812SM	8858	8834SM	8834
Sz	1/2"	5/8"	3/4"	3/4"
H	5"	4-7/8"	4-3/4"	5-3/4"
W	3"	3"	3"	3-1/2"
Base	1-1/8"	1-1/4"	1-1/2"	1-1/2"
Wgt	20 lbs.	20 lbs.	20 lbs.	40 lbs.
Pk	25	25	25	30



ORI-271-1 (SQUARE FIT)

Sz	1"
H	7-1/4"
W	3"
Base	1-1/2"
Wgt	21 lbs.
Pk	25



CL-731 (SQUARE FIT)

Item#	731	731H	731Y	731Z
Sz	1/2"	5/8"	3/4"	1"
H	6"	6"	6"	7"
W	3-1/8"	3-1/8"	3-1/8"	3-3/8"
Base	3/4"	1-1/8"	1-1/8"	1-1/2"
Wgt	17 lbs.	17 lbs.	17 lbs.	23 lbs.
Pk	30	30	30	30



ORI-272-1 (SQUARE FIT)

Sz	1"
H	7-5/8"
W	2-3/4"
Base	1-1/2"
Wgt	22 lbs.
Pk	25



CL-853 (SQUARE FIT)

Item#	853	85358	85334	853H	853Y
Sz	1/2"	5/8"	3/4"	5/8"	3/4"
H	4-1/2"	4-5/8"	4 5/8"	5-1/2"	6-5/8"
W	2-1/2"	2-5/8"	2-3/8"	3-1/4"	3-3/4"
Base	1-1/2"	1-5/8"	1-5/8"	1-3/4"	2"
Wgt	40 lbs.	20 lbs.	20 lbs.	22 lbs.	37 lbs.
Pk	40	40	25	20	20



ORI-273-1 (SQUARE FIT)

Sz	1"
H	5-1/4"
W	4"
Base	2"
Wgt	40 lbs.
Pk	45 pcs.



ORI-671 (SQUARE FIT)

Item#	671AF	671XL
Sz	3/4"	1"
H	5-1/8"	8-1/4"
W	1-5/8"	2"
Base	1-1/8"	1-1/2"
Wgt	36 lbs.	18 lbs.
Pk	30	10



ORI-9Z (SQUARE FIT)

Sz	1"
H	7-7/8"
W	2-1/8"
Base	1-3/4"
Wgt	16 lbs.
Pk	10

CAST IRON SPEARS



CL-662 (SQUARE FIT)

Sz	1"
H	7-3/4"
W	2-3/4"
Base	1-5/8"
Wgt	37 lbs.
Pk	25



ORI-219

Sz	4"
H	7-3/4"
Base	1-1/4"
Wgt	34 lbs.
Pk	45 pc

ORI-810 - (SQUARE FIT PINEAPPLE)

Item#	810	812	858	834
Fit	1"	1/2"	5/8"	3/4"
H	3"	2"	2-1/4"	2-1/2"
W	1-1/2"	1"	1-3/16"	1-3/8"
Wgt	23 lbs.	28 lbs.	22 lbs.	24 lbs.
Pk	40	130	48	65



CL-8X - (URN)

H	3"
Base	1-1/2"
Wgt	31 lbs.
Pk	90



ORI-657S - PINEAPPLE

H	4-1/2"
W	2-1/4"
Base	1-3/4" RD
Wgt	29 lbs.
Pk	18



The pineapple is recognized as a traditional expression of welcome throughout the United States. Appearing on all sorts of décor, the fruit symbolizes intangible assets we appreciate in a home- warmth, welcome, friendship, and hospitality.

CAST IRON DRIVE INS



ORI-215X	
Fit	1" Sq
H	4-1/4"
W	2"
Base	1"
Wgt	20 lbs.
Pk	50



CL-661	
Fit	1" Sq
H	3-3/8"
W	1-3/8"
Base	1-1/8"
Wgt	35 lbs.
Pk	50



ORI-227X	
Fit	1" Sq
H	4-3/4"
W	3"
Base	1"
Wgt	19 lbs.
Pk	30



CL-670CF	
Fit	1" Sq
H	5-1/8"
W	4-3/8"
Base	1-1/4"
Wgt	33 lbs.
Pk	30



ORI-413X	ORI-414X	
Fit	1" Sq	1-1/4" Sq
H	3/4"	3/4"
Wgt	24 lbs.	30 lbs.
Pk	180	120



ORI-6906X	
Fit	1" Sq
H	2-3/4"
W	1-1/4"
Wgt	47 lbs.
Pk	60



ORI-7X	ORI-7XL	
Fit	1" Sq	1-1/4" Sq
Dia.	1"	1-1/2"
H	2-1/2"	3-1/2"
W	1-3/4"	1-3/4"
Wgt	34 lbs.	38 lbs.
Pk	110	30



ORI-6914X	
Fit	3/4" Sq
H	4-1/4"
W	2"
Wgt	24 lbs.
Pk	50

CAST IRON CAPS



CAST IRON POST BALL - SQUARE FIT

Item#	Sz	Dia	H	Wgt	Pc/box
ORI-PB115	1"	1-1/8"	2-1/2"	24 lbs.	60
ORI-PB114	1-1/4"	1-1/8"	2-1/2"	20 lbs.	40
ORI-PB117	1-1/2"	1-5/16"	2-3/4"	30 lbs.	42
ORI-PB118H	2"	1-15/16"	3-5/8"	12 lbs.	12
ORI-PB121H	2-1/2"	2-1/8"	4-1/8"	20 lbs.	8
ORI-PB120H	3"	2-1/2"	4-1/2"	12 lbs.	4
ORI-PB119H	4"	2-3/4"	5"	13 lbs.	3
ORI-PB125	5"	3-1/4"	5"	25 lbs.	4
ORI-PB126	6"	3-7/8"	7-1/2"	36 lbs.	4



CAST IRON POST BALL - SQUARE FIT

Item#	Sz	Base	Dia.	H	Wgt	Pk
ORI-PB224	1"	1-3/4"	1-5/16"	2-3/4"	34 lbs.	60
ORI-PB224112	1-1/2"	1-1/2"	1-1/2"	2-3/4"	31 lbs.	40



CAST IRON POST BALL - ROUND FIT

Item#	Sz (in.)	Base (in.)	Dia. (in.)	H (in.)	Wgt (lbs.)	Pc/box
CL-9536	5/8"	1-3/4"	2-1/4"	3-1/8"	24 lbs.	20
CL-9537	3/4"	2-1/4"	2-7/8"	4"	19 lbs.	16
CL-9538	1"	2-7/8"	3-11/16"	5-1/4"	27 lbs.	9



CAST IRON PYRAMID CAP

Item#	Sz	H	Wgt	Pk
ORI-CIC141	1"	3/4"	27 lbs.	200
ORI-CIC142	1-1/2"	1"	21 lbs.	80
ORI-CIC143	2"	1"	19 lbs.	48
ORI-CIC144	3"	1-1/2"	18 lbs.	20
ORI-CIC145	4"	1-1/2"	15 lbs.	10
ORI-CIC146	1-1/4"	3/4"	28 lbs.	104
ORI-CIC147	2-1/2"	1-1/2"	20 lbs.	30
ORI-CIC150	5"	2"	28 lbs.	10
ORI-CIC149	6"	2"	28 lbs.	8
ORI-CIC148	9"	2-7/8"	45 lbs.	4

CAST IRON COLLARS



CL660 - ROUND FIT

Item#	CL66012	CL66058	CL66034
Sz	1/2"	5/8"	3/4"
H	2-5/8"	2-5/8"	2-5/8"
W	2-1/4"	2-1/4"	2-5/8"
Wgt	40 lbs.	32 lbs.	38 lbs.
Pk	60	60	60



CL612 - SQUARE FIT

Item#	CL612	CL61258
Sz	1/2"	5/8"
H	1-1/2"	1-9/16"
W	1-3/4"	1-7/8"
Wgt	18 lbs.	23 lbs.
Pk	50	50



CL8127 - ROUND FIT

#	CL8127	CL8587	CL8347	CL8117
Sz	1/2"	5/8"	3/4"	1"
H	1-5/16"	1-7/16"	1-1/2"	1-7/8"
W	1-1/2"	1-5/8"	1-15/16"	2-1/4"
Wgt	16 lbs.	20 lbs.	15 lbs.	20 lbs.
Pk	100	80	60	40



CL8518 - SQUARE FIT

Item#	CL8518	CL851858
Sz	1/2"	5/8"
H	1-3/4"	1-3/4"
W	1-7/8"	2"
Wgt	20 lbs.	25 lbs.
Pk	40	50

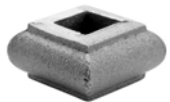

CL8521 - SQUARE FIT

#	8521-12	8521-58	8521-34
Sz	1/2"	5/8"	3/4"
H	3/4"	1"	1"
W	1-1/4"	1-5/8"	1-15/16"
Wgt	18 lbs.	20 lbs.	15 lbs.
Pk	200	80	60



CL8526 - SQUARE FIT

Item#	CL8526	CL8526H	CL8526Y	CL8526Z
Sz	1/2"	5/8"	3/4"	1"
H	1-5/8"	1-7/8"	1-7/8"	2-1/4"
W	1-5/8"	1-7/8"	2-1/8"	2-5/8"
Wgt	35 lbs.	28 lbs.	27 lbs.	20 lbs.
Pk	80	50	40	20



CL8527 - SQUARE FIT

Item#	CL8527	CL8527H	CL8527Y
Sz	1/2"	5/8"	3/4"
H	1-7/8"	1-7/8"	1-7/8"
W	1-3/16"	1-1/4"	2"
Wgt	23 lbs.	29 lbs.	31 lbs.
Pk	100	100	100



CAST IRON HALF KNUCKLE

Item#	ORIHK12	ORIHK58	ORIHK34	ORIHK1
Sz	1/2"	5/8"	3/4"	1"
H	2"	1-7/8"	1-7/8"	2-1/2"
W	1-1/2"	1-5/8"	1-7/8"	2-1/2"
Wgt	27 lbs.	25 lbs.	26 lbs.	13 lbs.
Pk	85	70	55	20

CAST IRON SHOES



ORI - SHLL	
Fit	1" SQ Tubing
Ears	1
Depth	1-3/8"
W	2-3/8"
Wgt	25 lbs.
Pk	55



ORI - SHMM	
Fit	1" SQ Tubing
Ears	1
Depth	1-3/8"
W	2-3/8"
Wgt	17 lbs.
Pk	45



ORI - SHDD		
Item#	DD	DD34
Sz	1"	3/4"
Depth	2"	2"
Wgt	32 lbs.	25 lbs.
Pk	64	52



ORI - SHEE	
Fit	1/2" SQ Tubing
Ears	2
Depth	1"
Base	2-1/4" SQ
Wgt	17 lbs.
Pk	120



ORI - SHCC	
Fit	1" SQ Tubing
Ears	Flanged
Depth	2"
Base	3-1/4" SQ
Wgt	21 lbs.
Pk	22



ORI - SHHH	
Fit	1-1/2" Sq Tubing
Ears	2
Depth	2"
Base	2-1/2" SQ
Wgt	12 lbs.
Pk	8



CL - SHBB	
Fit	1" SQ Tubing
Ears	2
Depth	1-1/4"
Base	2-1/4" SQ
Wgt	46 lbs.
Pk	75



CL - SHRR	
Fit	1-1/4" SQ Tubing
Ears	2
Depth	1-1/4"
Base	2-1/2" SQ
Wgt	33 lbs.
Pk	50

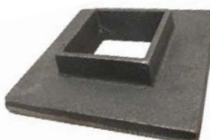

CL - SHKK2	
Fit	2" Sq. Tubing
Depth	1"
Base	4-7/8" SQ
Wgt	46 lbs.
Pk	20

CAST IRON SHOES



CAST IRON SHOE - SQUARE FIT

Item#	CL9503	CL9503-58
Sz	1/2"	5/8"
H	7/8"	7/8"
W	1-1/2"	1-1/2"
Pk	160	160
Wgt	24 lbs.	27 lbs.



CAST IRON SHOE - ROUND FIT

Item#	CLHK8127	CLHK8587	CLHK8347
Sz	1/2"	5/8"	3/4"
H	3/4"	3/4"	1"
W	1-1/4"	1-1/2"	1-3/4"
Pk	150	100	80
Wgt	19 lbs.	15 lbs.	15 lbs.



CAST IRON COVER SHOE - (ORI-CSH)

Item#	CSH1	CSH114	CSH112	CSH2
Sz	1"	1-1/4"	1-1/2"	2"
H	1-7/8"	1-7/8"	2"	2"
W	3-3/8"	3-1/2"	3-1/2"	4-5/8"
Pk	25	25	25	25
Wgt	19 lbs.	20 lbs.	21 lbs.	34 lbs.
Sq. Fit	3"	3"	3"	4"



CAST IRON SHOE - ROUND FIT

Item#	ORI-SH356	ORI-SH357
Sz	1/2"	5/8"
H	1"	1-3/16"
W	1-1/4"	1-3/8"
Pk	150	90
Wgt	22 lbs.	20 lbs.



CSH1 depicted.



CAST IRON SHOE - SQUARE FIT

Item#	ORI-SH352	ORI-SH353	ORI-SH354
Sz	1/2"	5/8"	3/4"
H	1-1/16"	1-1/16"	1-1/16"
W	1-1/4"	1-1/4"	1-3/8"
Pk	120	120	100
Wgt	32 lbs.	25 lbs.	30 lbs.

CAST IRON ROSETTES, RINGS, SPHERES



CL681		
Item#	CL681SF	CL681DF
Faces	Single	Double
Dia.	4"	4"
Wgt	22 lbs.	27 lbs.
Pk	45	15



CAST IRON BALL (ORI-BCI)				
Item#	BCI-134	BCI-1	BCI-112	BCI-2
Sz	3/4"	1"	1-1/2"	2"
Pk	500	250	50	25
Wgt	32 lbs.	25 lbs.	30 lbs.	26 lbs.



CL9050		
Item#	CL9050SF	CL9050DF
Faces	Single	Double
Dia.	3"	3"
Wgt	32 lbs.	23 lbs.
Pk	130	100



CL9052		
Item#	CL9052SF	CL9052DF
Faces	Single	Double
Dia.	2-5/8"	2-5/8"
Wgt	28 lbs.	33 lbs.
Pk	100	80



CE63102 depicted



CL9053	
Item#	CL9053SF
Faces	Single
Dia.	4"
Wgt	22 lbs.
Pk	45



CL9054		
Item#	CL9054SF	CL9054DF
Faces	Single	Double
Dia.	3"x2"	3"x2"
Wgt	31 lbs.	35 lbs.
Pk	100	70



BEVELED CAST IRON RING			
Item#	ORI833	ORI844	ORI835
O.D.	3"	4"	5-1/4"
Pk	44	50	20
Wgt	25 lbs.	45 lbs.	23 lbs.

CAST IRON RAIL ENDS



CAST IRON RAILEND	
Item#	CL-5A
Length	4-1/2"
Wgt	22 lbs.
Pk	50



MOLDED LAMBS TONGUE			
Item#	ORI-RE199	ORI-RE199L	ORI-RE199XL
Sz	1-3/4"	2"	2-1/4"
H	5"	4-1/2"	5"
Wgt	22 lbs.	54 lbs.	28 lbs.
Pk	20	30	12



CAST IRON RAILEND	
Item#	CL-5LT
Length	5-3/4"
Wgt	44 lbs.
Pk	50



MOLDED LAMBS TONGUE			
Item#	ORI-RE6928	ORI-RE6928L	ORI-RE6928XL
Sz	1-3/4"	2"	2-1/4"
H	5-1/2"	5-1/2"	5-3/8"
Wgt	19 lbs.	52 lbs.	35 lbs.
Pk	20	35	24



CAST IRON RAILEND	
Item#	CL-6LT
Length	6"
Wgt	33 lbs.
Pk	50



MOLDED VOLUTES			
Item#	ORI-RE201	ORI-RE201L	ORI-RE201XL
Sz	1-3/4"	2"	2-1/4"
H	2-5/8"	2-5/8"	2-5/8"
W	4"	4"	4-3/4"
Wgt	30 lbs.	50 lbs.	23 lbs.
Pk	30	25	15

TUBULAR RAIL ENDS



CL-902	
Item#	CL-902
Length	1-3/4"x4-1/4"
Wgt	36 lbs.
Pk	30



CL-7056	
Item#	CL-7056
Length	1-3/4"x1"
Wgt	36 lbs.
Pk	50



CL-901	
Item#	CL-901
Length	1-2/3"x3-1/2"
Wgt	30 lbs.
Pk	35



CL-900	
Item#	CL-900
Length	2-5/8"x2-1/4"
Wgt	42 lbs.
Pk	30

TUBULAR RAIL ENDS



ORI-SH654

Fit	1" Channel
Ears	1
Height	2-3/4"
Width	2-5/16"
Wgt	44 lbs.
Pk	44



ORI-SH653

Fit	1" Channel
Ears	1
Depth	2-1/8"
W	1-3/4"
Wgt	28 lbs.
Pk	150



CL3A depicted.

CAST IRON BRACKETS



CL-BH3A

Fit	Sq Fit
H	2-3/4"
W	2-1/2"
Hole Sz.	3/8"
Extend.	2-1/2"
Wgt	38 lbs.
Pk	50



CL-BH3B

Fit	Sq Fit
H	3-1/2"
W	2-1/2"
B	2-1/2" Dia.
Hole Sz.	3/8"
Extend.	3"
Wgt	32 lbs.
Pk	50

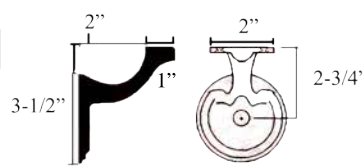
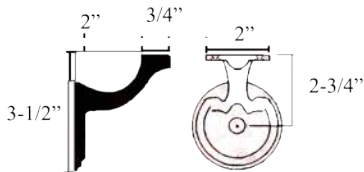

ORI-BH93R

Fit	Sq Fit
H	3-1/2"
W	2"
B	2-1/2"
Hole Sz.	3/8"
Extend.	2-1/2"
Wgt	16 lbs.
Pk	20



CL-BH3HRB

Fit	Sq Fit
H	5"
W	2-3/4"
Hole Sz.	3-3/4"
Extend.	3-1/2"
Wgt	33 lbs.
Pk	20

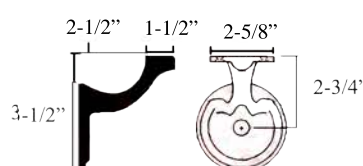
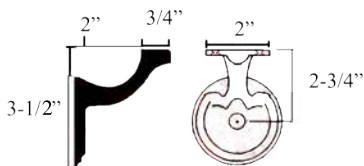

CAST IRON ORNAMENTAL CASTING



ORI-CIC21C	
Fit	1/2"
Height	14-7/8"
Width	7-1/2"
Pk	5
Weight	25 lbs.



ORI-CIC6702	
Fit	1/2"
Height	14-7/8"
Width	7-5/8"
Pk	10
Weight	23 lbs.



ORI-CIC22C	
Fit	1/2"
Height	16"
Width	7-1/2"
Pk	5
Weight	27 lbs.



ORI-CIC6711	
Fit	1/2"
Height	13-1/2"
Width	7-1/4"
Pk	10
Weight	20 lbs.



ORI-CIC23C	
Fit	1/2"
Height	15-1/4"
Width	7-1/4"
Pk	5
Weight	25 lbs.



ORI-CIC6714	
Fit	1/2"
Height	3-3/4"
Width	3-3/4"
Pk	25
Weight	18 lbs.



ORI-CIC6701	
Fit	1/2"
Height	14-1/8"
Width	6-1/2"
Pk	10
Weight	22 lbs.



ORI-CIC6716	
Fit	1/2"
Height	13-1/4"
Width	6-3/4"
Pk	10
Weight	23 lbs.

CAST IRON ORNAMENTAL CASTING



ORI-CIC198	
Height	7"
Width	4"
Pk	20
Weight	23 lbs.



CL-440	
Height	4"
Width	5-3/8"
Pk	80
Weight	46 lbs.



CL-145	
Fit	1/2"
Height	7-3/4"
Width	6-3/4"
Pk	12
Weight	20 lbs.



ORI-CIC6717	
Fit	1/2"
Height	17-7/8"
Width	7-1/2"
Pk	10
Weight	30 lbs.



ORI-CIC197	
Height	9"
Width	6-3/4"
Pk	22
Weight	25 lbs.



CL-89BXL	
Dia.	1"
Height	36"
Width	1" to 2-1/4"
Pk	5
Weight	60 lbs.



CL-A3	
Height	4"
Width	31-5/8"
Pk	5
Weight	34 lbs.

CAST IRON ORNAMENTAL CASTING



CL-22	
Height	20-1/4"
Width	8"
Pk	5
Weight	28 lbs.



CL-34	
Fit	1/2"
Height	10-1/4"
Width	8-1/4"
Pk	25
Weight	52 lbs.



CL-23A	
Height	16-1/8"
Width	16-1/8"
Pk	5
Weight	42 lbs.



CL-35	
Fit	1/2"
Height	15-1/2"
Width	8-1/4"
Pk	5
Weight	15 lbs.



CL-32	
Fit	1/2"
Height	16-1/8"
Width	8-3/4"
Pk	5
Weight	20 lbs.



CL-65	
Height	18-1/2"
Width	7"
Pk	5
Weight	30 lbs.



CL-679XL	
Fit	1/2"
Height	6-1/2"
Width	8-1/4"
Pk	25
Weight	50 lbs.



CL-74X	
Height	18-1/2"
Width	18"
Pk	5
Weight	40 lbs.

CAST IRON ORNAMENTAL CASTING



CL-80C	
Height	15-1/2"
Width	15-1/2"
Pk	5
Weight	36 lbs.



CL-85	
Height	24-3/4"
Width	8-1/8"
Pk	5
Weight	65 lbs.



CL-81	
Height	15-1/2"
Width	8-1/2"
Pk	5
Weight	42 lbs.



CL-A2	
Height	4-1/8"
Width	25-5/8"
Pk	5
Weight	29 lbs.



CL-82	
Height	22"
Width	8-1/2"
Pk	5
Weight	55 lbs.



CL-8333	
Fit	1/2"
Height	17"
Width	6-3/4"
Pk	5
Weight	13 lbs.



CE-6711 & CL-A2 depicted.

CAST IRON ORNAMENTAL CASTING



CL-A to Z & CL-N1 to 9	
Height	5"
Pk	10
Weight	3 lbs.



CL-100	
Height	12-1/2"
Width	31"
Pk	1
Weight	15 lbs.



ORI-REL400-L (right) / ORI-REL400-R (right)

CAST IRON RAIL END LATERAL - TOP						
Item #	Size	H	W	Wgt.	Pk	
ORI-REL400-R/L	1-3/4"	10"	12"	16 lbs.	5	
ORI-REL420-R/L	2"	9"	11-3/8"	22 lbs.	5	
ORI-REL440-R/L	2-1/4"	10"	12-1/4"	30 lbs.	5	
DUC-REL400-R/L	1-3/4"	10"	12"	16 lbs.	5	
DUC-REL420-R/L	2"	9"	11-3/8"	22 lbs.	5	
DUC-REL440-R/L	2-1/4"	10"	12"	30 lbs.	5	

*All items are available in malleable iron versions.



ORI-REC401-L (left) / ORI-REC401-R (right)

CAST IRON RAIL END CHANNEL - BOTTOM						
Item #	Size	H	W	Wgt.	Pk	
ORI-REC401-R/L	1-3/4"	10-1/2"	12-1/4"	11 lbs.	5	
ORI-REC421-R/L	2"	8-1/2"	10-1/2"	13 lbs.	5	
ORI-REC441-R/L	2-1/4"	10"	11-1/2"	15 lbs.	5	
DUC-REC401-R/L	1-3/4"	10-1/2"	12-1/4"	11 lbs.	5	
DUC-REC421-R/L	2"	8-1/2"	10-1/2"	13 lbs.	5	
DUC-REC441-R/L	1-3/4"	10"	11-1/2"	15 lbs.	5	

*All items are available in malleable iron versions.

CAST IRON POSTS



ORI-657P	
Height	7"
Width	3-3/8"
Pk	12
Weight	41 lbs.



ORI-P6000	
Height	27-5/8"
Top Width	5-1/4"
Base Width	6-1/2"
I.Dia.	2-1/2"
Pk	Each
Weight	28 lbs.



ORI-6732T (FOR 6031)	
Height	9"
Width	6-1/2"
Pk	1 SET
Weight	21 lbs.



ORI-P6031	
Height	28"
I.Dia.	4-1/2"
Pk	1 Set
Weight	102 lbs



Shown: ORI-P6000



ORI-P6002	
Fit	Base for 6031
Width	10" Sq.
Pk	Each
Weight	10 lbs/pc

ALUMINUM PICKET CASTINGS



AL-2

Height: 16-1/2"
Width: 7-1/8"
Double Faced
Packed 40 pcs/box
Weight 40 lbs/box
Available in 1/2", 5/8", 3/4"
Available w/Screwholes
Available in White/Black



AL-13

Height: 8-1/4"
Width: 6-5/8"
Double Faced
Packed 40 pcs/box
Weight 22 lbs/box
Available in 1/2"



AL-3

Height: 12-7/8"
Width: 6-3/4"
Single Faced
Packed 40 pcs/box
Weight 40 lbs/box
Available in 1/2", 5/8", 3/4"
Available w/Screwholes
Available in White/Black



AL-21

Height: 15"
Width: 7-1/2"
Single Faced
Packed 20 pcs/box
Weight 37 lbs/box
Available in 1/2", 5/8", 3/4"
Available w/Screwholes



AL-8

Height: 4"
Width: 4"
Single Faced
Packed 200 pcs/box
Weight 52 lbs/box
Available in 1/2", 5/8", 3/4"
Available w/Screwholes
Available in White/Black



AL-12

Height: 12-5/8"
Width: 6-3/4"
Double Faced
Packed 40 pcs/box
Weight 36 lbs/box
Available in 1/2"
Available w/Screwholes

ALUMINUM PICKET CASTINGS



AL-192

Height: 13-3/8"
 Width: 7-1/8"
 Double Faced
 Packed 40 pcs/box
 Weight 38 lbs/box
 Available in 1/2", 5/8", 3/4"



AL-03038

Height: 18"
 Width: 6-1/2"
 Single Faced
 Packed 20 pcs/box
 Weight 27 lbs/box
 Available in 1/2", 5/8"
 Available w/ Screwholes



AL-196

Height: 6"
 Width: 7-1/2"
 Single Faced
 Packed 80 pcs/box
 Weight 45 lbs/box
 Available in 1/2"



AL-03039

Height: 18-1/2"
 Width: 6-3/4"
 Single Faced
 Packed 20 pcs/box
 Weight 30 lbs/box
 Available in 1/2", 5/8"
 Available w/ Screwholes



AL-244

Height: 6-5/8"
 Width: 5-1/2"
 Double Faced
 Packed 80 pcs/box
 Weight 52 lbs/box
 Available in 1/2", 5/8", 3/4"



AL-03068

Height: 13-7/8"
 Width: 7-1/2"
 Single Faced
 Packed 20 pcs/box
 Weight 33 lbs/box
 Available in 1/2"
 Available w/ Screwholes



AL-245

Height: 16"
 Width: 6-1/2"
 Double Faced
 Packed 30 pcs/box
 Weight 41 lbs/box
 Available in 1/2", 5/8", 3/4"
 Available w/ Screwholes



AL-187

Height: 8-1/2"
 Width: 4-3/4"
 Single Faced
 Packed 80 pcs/box
 Weight 57 lbs/box
 Available in 1/2", 5/8", 3/4"

ALUMINUM PICKET CASTINGS



AL-252

Height: 21-1/4"
Width: 8-1/4"
Packed 20 pcs/box
Weight 48 lbs/box
Available in 1/2", 5/8", 3/4"



AL-26

Height: 15-1/4"
Width: 8"
Double faced
Packed 20 pcs/box
Weight 35 lbs/box
Available in 1/2"

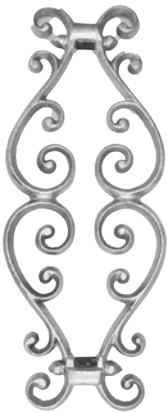

AL-275

Height: 14-1/2"
Width: 5-5/8"
Packed 20 pcs/box
Weight 26 lbs/box
Available in 1/2", 5/8", 3/4"



AL-CE1

Height: 14"
Width: 6-3/8"
Packed 40 pcs/box
Weight 40 lbs/box
Available in 1/2", 3/4"



AL-21SF

Height: 16-1/4"
Width: 8-1/4"
Single Face
Packed 20 pcs/box
Weight 42 lbs/box
Available in 1/2"
Available w/ Screwholes &/or
No tabs



AL-5

Height: 14-3/8"
Width: 7-1/4"
Packed 40 pcs/box
Weight 42 lbs/box
Available in 1/2"



AL-27

Height: 9"
Width: 7"
Double faced
Packed 60 pcs/box
Weight 45 lbs/box
Available in 1/2"

ALUMINUM CASTINGS

ROSE DESIGN



AL-101

Height: 10-1/4"
Width: 25-1/4"
Packed 10 pcs/box
Weight 52 lbs/box
With Weld Tabs



AL-107

Height: 15-1/2"
Width: 6-5/16"
Packed 20 pcs/box
Weight 27 lbs/box
With Weld Tabs
Available in 1/2", 5/8", 3/4"
Available with Screwholes



AL-102

Height: 14-1/8"
Width: 8-1/2"
Packed 20 pcs/box
Weight 42 lbs/box
With Weld Tabs



AL-103

Height: 13-5/16"
Width: 7-3/8"
Packed 20 pcs/box
Weight 35 lbs/box
With Weld Tabs
Available in 1/2", 5/8"



AL-105

Height: 28"
Width: 8-3/8"
Packed 10 pcs/box
Weight 41 lbs/box
With Weld Nuts



AL-110

Height: 8-1/2"
Width: 18-1/2"
Packed 20 pcs/box
Weight 33 lbs/box
With Weld Tabs



AL-106

Height: 20-3/8"
Width: 6-3/8"
Packed 20 pcs/box
Weight 37 lbs/box
With Weld Nuts



AL-113

Height: 23-3/4"
Width: 7-3/8"
Packed 20 pcs/box
Weight 54 lbs/box
With Weld Nuts

ALUMINUM CASTINGS



AL-109

Height: 22-1/2"
 Width: 8-1/2"
 Packed 10 pcs/box
 Weight 43 lbs/box
 With Weld Tabs

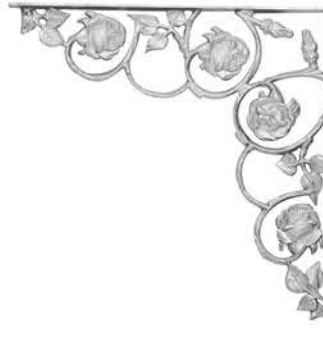

AL-115B

Height: 15-1/4"
 Width: 15-1/4"
 Packed 20 pcs/box
 Weight 41 lbs/box
 With Weld Tabs



AL-156

Height: 4-5/8"
 Width: 21-3/4"
 Packed 20 pcs/box
 Weight 38 lbs/box
 With Weld Nuts



AL-181

Height: 22-1/2"
 Width: 8-1/2"
 Packed 10 pcs/box
 Weight 43 lbs/box
 With Weld Tabs



AL-182

Height: 16-7/8"
 Width: 7-3/4"
 Double Faced
 Packed 20 pcs/box
 Weight 38 lbs/box
 Available in 1/2", 5/8", 3/4"



AL-183

Height: 25-1/4"
 Width: 8-1/2"
 Packed 10 pcs/box
 Weight 53 lbs/box
 With Weld Tabs



AL-258

Height: 4-1/4"
 Width: 21-1/4"
 Packed 20 pcs/box
 Weight 39 lbs/box
 With Weld Nuts



AL-190S

Height: 10"
 Width: 20-3/4"
 Packed 10 pcs/box
 Weight 21 lbs/box
 With Weld Nuts

ALUMINUM CASTINGS

OAK DESIGN

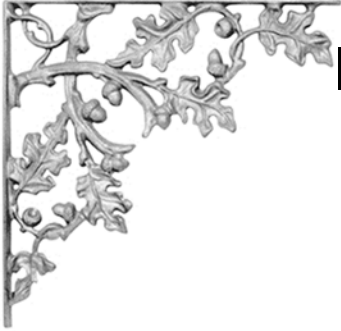

AL-154

Height: 16-1/2"
Width: 16-1/2"
Packed 20 pcs/box
Weight 55 lbs/box
With Weld Nuts

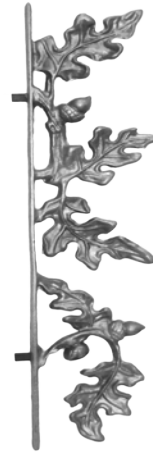

AL-158

Height: 4-1/4"
Width: 21-5/8"
Packed 20 pcs/box
Weight 29 lbs/box
With Weld Tabs



AL-124

Height: 27-3/4"
Width: 8-3/8"
Packed 10 pcs/box
Weight 46 lbs/box
With Weld Nuts

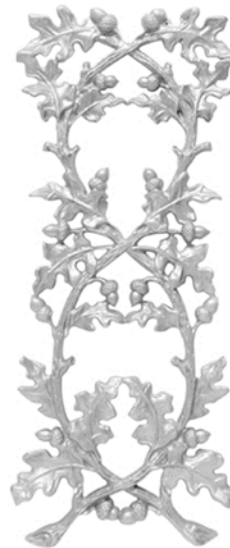

AL-148

Height: 26-1/4"
Width: 10-3/4"
Packed 10 pcs/box
Weight 41 lbs/box
With Weld Tabs



AL-151

Height: 20"
Width: 7-3/4"
Packed 10 pcs/box
Weight 26 lbs/box
With Weld Nuts



AL-21

Height: 15"
Width: 7-1/2"
Double Faced
Packed 20 pcs/box
Weight 37 lbs/box
With Weld Tabs
Available in 1/2", 5/8", 3/4"

ALUMINUM CASTINGS



AL-119

Height: 26"
Width: 8"
Packed 10 pcs/box
Weight 44 lbs/box
With Weld Nuts



AL-120

Height: 27-1/2"
Width: 7-5/8"
Packed 10 pcs/box
Weight 38 lbs/box
With Weld Nuts



AL-23

Height: 16-1/4"
Width: 7-5/8"
Packed 20 pcs/box
Weight 36 lbs/box
With Weld Tabs
In 1/2", 5/8", 3/4"



AL-130

Height: 20-3/8"
Width: 7-1/8"
Packed 20 pcs/box
Weight 44 lbs/box
With Weld Nuts



AL-122

Height: 12"
Width: 29-1/2"
Packed 10 pcs/box
Weight 60 lbs/box
With Weld Nuts



AL-560

Height: 7-3/4"
Width: 7-3/4"
Packed 20 pcs/box
Weight 28 lbs/box
With Weld Tabs



AL-564

Height: 21-1/2"
Width: 4"
Packed 20 pcs/box
Weight 33 lbs/box
With Weld Tabs

ALUMINUM CASTINGS



AL-552

Height: 25-1/2"
 Width: 8-3/4"
 Packed 10 pcs/box
 Weight 49 lbs/box
 With Weld Tabs



AL-270

Height: 27-1/8"
 Width: 12"
 Packed 10 pcs/box
 Weight 48 lbs/box
 With Weld Tabs



AL-247

Height: 29"
 Width: 8"
 Packed 10 pcs/box
 Weight 35 lbs/box
 With Weld Nuts

Symbolism involving the grapevine dates back thousands of years, when the ancient Greek used the grapevine as a symbol of fertility and prosperity. Our Grape or Vineyard castings continue this tradition.

LION DESIGN



Right



Left

AL-762

Height: 10-1/2"
 Width: 8"
 Packed 20 pcs/box
 Weight: 38 lbs/box
 Left and Right
 With Weld Tabs



Right



Left

AL-1000

Height: 29-1/2"
 Width: 14-1/4"
 Packed 5 pcs/box
 Weight: 44 lbs/box
 Left and Right
 With Weld Tabs

ALUMINUM CASTINGS



AL-3702



AL-3703

AL-3702 & AL-3703

Height: 23"
Width: 13-3/4"
Packed 10 pcs/box
Weight 30.7 lbs/box
Single faced

AL-3702 Left facing
AL-3703 Right Facing



AL-3705



AL-3706

AL-3705 & AL-3706

Height: 14-7/8"
Width: 9-1/2"
Packed 10 pcs/box
Weight 31 lbs/box
Single faced

AL-3705 Left facing
AL-3706 Right Facing



AL-3711



AL-3712

AL-3711 & AL-3712

Height: 15-3/8"
Width: 5-5/8"
Packed 40 pcs/box
Weight 47.6 lbs/box
Single faced

AL-3711 Left facing
AL-3712 Right Facing



AL-719

Height: 9-1/2"
Width: 19-1/2"
Packed 12 pcs/box
Weight 3 lbs/box
With Weld Nuts
Single faced

ALUMINUM CASTINGS

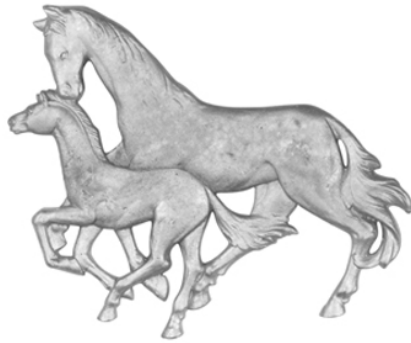

AL-718

Height: 14"
Width: 16-5/8"
Packed 10 pcs/box
Weight 38.4 lbs/box
Single faced



AL-717

Height: 19"
Width: 36"
Packed 10 pcs/box
Weight 56 lbs/box
Single faced



AL-61

Height: 7"
Width: 16-3/8"
Packed 20 pcs/box
Weight 19.3 lbs/box
Single faced



AL-62

Height: 5-1/2"
Width: 19-1/2"
Packed 20 pcs/box
Weight 22.3 lbs/box
Single faced



AL-63

Height: 9-3/4"
Width: 26-3/8"
Packed 10 pcs/box
Weight 26 lbs/box
Single faced

ALUMINUM CASTINGS



AL-135

Height: 19-1/8"
Width: 6-1/2"
Packed 20 pcs/box
Weight 36 lbs/box
With Weld Tabs



AL-142

Height: 16-3/4"
Width: 7-1/4"
Packed 40 pcs/box
Weight 50 lbs/box
With Weld Nuts



AL-134

Height: 25-1/2"
Width: 8-1/2"
Packed 10 pcs/box
Weight 41 lbs/box
With Weld Tabs



AL-146

Height: 22-1/2"
Width: 11-1/4"
Packed 10 pcs/box
Weight 42 lbs/box
With Weld Nuts



AL-138

Height: 26"
Width: 7-1/4"
Packed 10 pcs/box
Weight 44 lbs/box
With Weld Tabs



AL-M2 depicted.

ALUMINUM CASTINGS

IVY LEAF DESIGN



AL-216

Height: 5"
Width: 18-3/4"
Packed 20 pcs/box
Weight 24 lbs/box
With Weld Tabs



AL-117

Height: 30"
Width: 8"
Packed 10 pcs/box
Weight 61 lbs/box
With Weld Nuts



AL-48

Height: 15"
Width: 8"
Packed 20 pcs/box
Weight 27 lbs/box
With Weld Tabs



AL-176

Height: 13-1/4"
Width: 16-3/4"
Packed 20 pcs/box
Weight 36 lbs/box
With Weld Tabs

CONTEMPORARY DESIGN



AL-238

Height: 18-3/4"
Width: 9-3/4"
Packed 20 pcs/box
Weight 43 lbs/box
With Weld Nuts

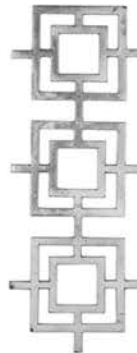

AL-03700

Height: 23-1/8"
Width: 9-1/2"
Thickness: 3/8"
Packed 10 pcs/box
Weight 34 lbs/box
With Weld Tabs

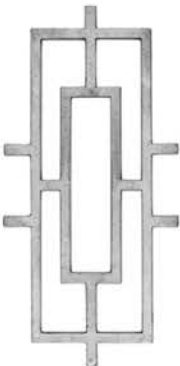

AL-03023

Height: 15-3/4"
Width: 7-5/8"
Packed 20 pcs/box
Weight 25 lbs/box
With Weld Tabs



AL-709F

Height: 13-1/2"
Width: 4-1/8"
Packed 40 pcs/box
Weight 32 lbs/box
With Weld Tabs

ALUMINUM - STORM DOOR CASTING



AL-M1

Height: 33-1/4"
Width: 8-1/2"
Packed 10 pcs/box
Weight 38 lbs
Available with screwholes:
AL-M1SH

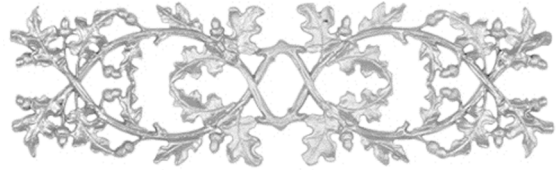

AL-M3

Height: 33-1/4"
Width: 10"
Packed 10 pcs/box
Weight 50 lbs
Available with screwholes:
AL-M3SH



AL-M2

Height: 28-1/4"
Width: 8"
Packed 10 pcs/box
Weight 35 lbs
Available with screwholes:
AL-M2SH

AL-M2S

Height: 27-1/4"
Width: 8"
Packed 10 pcs/box
Weight 44 lbs



AL-M4

Height: 5-1/4"
Width: 33-1/4"
Packed 20 pcs/box
Weight 58 lbs
Available with screwholes:
AL-M4SH



AL-M5

Height: 4-3/8"
Width: 32"
Packed 20 pcs/box
Weight 28 lbs.
Available with screwholes:
AL-M5SH



AL-M6

Height: 33-1/4"
Width: 7-3/4"
Packed 10 pcs/box
Weight 40 lbs
Available with screwholes:
AL-M6SH



AL-M7

Height: 33-1/4"
Width: 8"
Packed 10 pcs/box
Weight 37 lbs
Available with screwholes:
AL-M7SH



AL-M8

Height: 33-1/4"
Width: 8-1/2"
Packed 10 pcs/box
Weight 60 lbs
Available with screwholes:
AL-M8SH

ALUMINUM - STORM DOOR CASTING



AL-M12

Height: 4-3/4"
 Width: 30-3/4"
 Packed 20 pcs/box
 Weight 53 lbs
 Available with screwholes:
 AL-M12SH



AL-M14

Height: 5"
 Width: 31-1/4"
 Packed 10 pcs/box
 Weight 33 lbs
 Available with screwholes:
 AL-M14SH



AL-M11

Height: 4"
 Width: 30-7/8"
 Double faced
 Packed 20 pcs/box
 Weight 45 lbs
 Available with screwholes:
 AL-M11SH

AL-M13

Height: 5-1/4"
 Width: 30-7/8"
 Double faced
 Packed 20 pcs/box
 Weight 45 lbs
 Available with screwholes:
 AL-M13SH



AL-442L

Height: 3-1/2"
 Width: 31-3/4"
 Packed 20 pcs/box
 Weight 33 lbs



AL-204BNB

Height: 16-3/4"
 Width: 16-3/4"
 Packed 20 pcs/box
 Weight 44 lbs/box
 Available with screwholes
 *Acorns backed out on reverse side



AL-MS13

Height: 5"
 Width: 10"
 Packed 40 pcs/box
 Weight 23 lbs/box



AL-MS14

Height: 5-1/8"
 Width: 9-5/8"
 Packed 40 pcs/box
 Weight 26 lbs/box

ALUMINUM - HANDRAIL BRACKETS

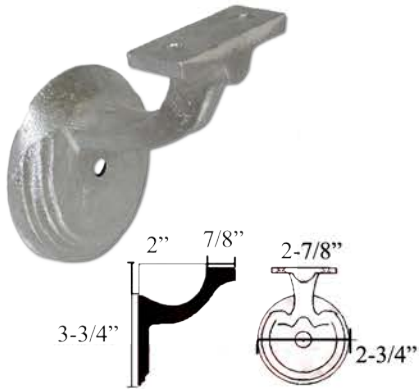

AL-BH3A

For Square Tubing
Extends 2-1/2" from wall
Packed 100 pcs/box
34 lbs/box

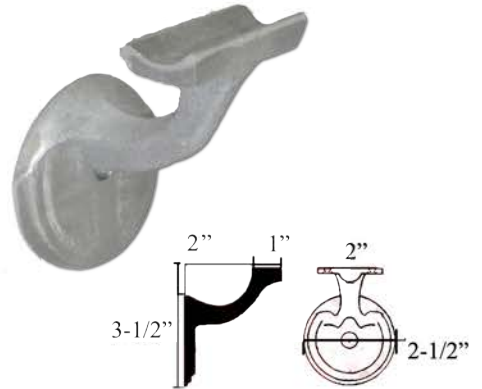

AL-BH93R

For Round Tubing
Extends 2-1/2" from wall
Packed 100 pcs/box
31 lbs/box

Aluminum has high resistance to corrosion under the majority of service conditions, as no colored salts form to stain or discolor adjacent surfaces.

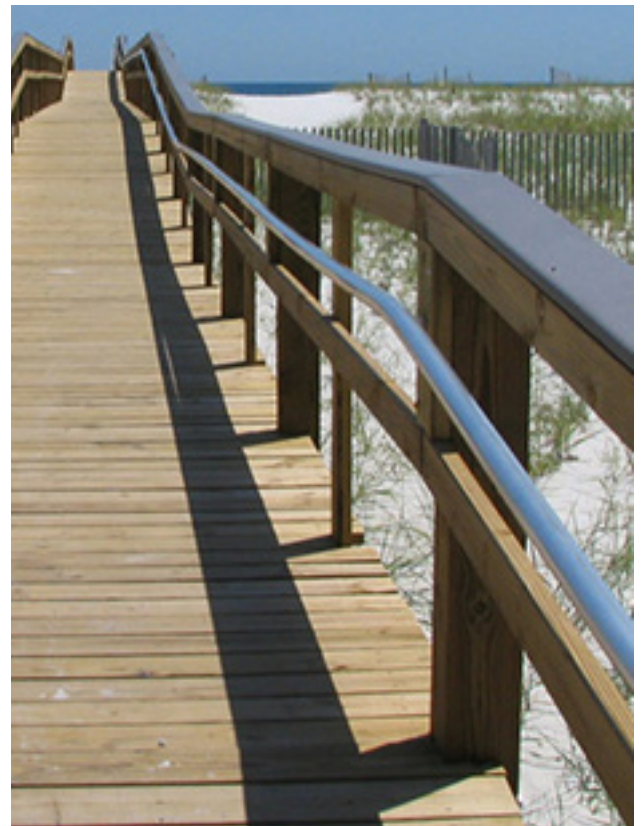

AL-BH93R shown.

ALUMINUM - SPEARS, CAPS, & SHOES



ALUMINUM POSTBALL (DIECAST)					
Item#	Fit	Ball Dia.	H	Wgt	Pk
AL-118D	2"	2"	3-3/4"	13 lbs.	20/box
AL-121D	2-1/2"	2"	4-1/4"	21 lbs.	20/box
AL-120D	3"	2-1/4"	4-1/2"	25 lbs.	20/box
AL-119D	4"	2-1/2"	5-1/4"	38 lbs.	20/box



AL-215D

Die Cast Aluminum
 Height: 4-3/8" x 2-1/4"
Available: 1/2" & 3/4"
 Packed 100 pcs/box
 13 lbs/box



AL-SHLL

For 1" Square Tubing
 One ear
 Packed 100 pcs/box
 22 lbs/box



AL-217B

Die Cast Aluminum
 Available in: 1/2", 5/8", 3/4"
 Height: 4"
 Packed 100 pcs/box
 13 lbs/box



AL-SHMM

For 1" Square Tubing
 Packed 100 pcs/box
 24 lbs/box



AL-9Z

For 1" Square Tubing
 Packed 50 pcs/box
 39 lbs/box



AL-SHRR

For 1-1/4" Square Tubing
 Packed 100 pcs/box
 26 lbs/box



A251D - ALUMINUM COLLAR (DIECAST)					
Item#	Size	Dia.	H	Wgt	Pk
AL-251-12D	1/2"	1-3/4"	1-1/2"	15 lbs.	100/box
AL-251-58D	5/8"	1-3/4"	1-3/4"	22 lbs.	100/box
AL-251-34D	3/4"	1-15/16"	2"	29 lbs.	100/box
AL-251-1D	1"	2-1/16"	2-1/2"	44 lbs.	100/box

ALUMINUM - SPEARS, CAPS, & SHOES



ALUMINUM PYRAMID CAP(DIECAST)

Item#	Fit	Wgt.	Pk
AL-142D	1-1/2"	14 lbs.	100/box
AL-143D	2"	18 lbs.	100/box
AL-147D	2-1/2"	31 lbs.	100/box
AL-144D	3"	40 lbs.	100/box
AL-145D	4"	48 lbs.	100/box



ALUMINUM COVER SHOE

Item#	Fit	B	H	W	Wgt.	Pk
AL-SH1	1"	3"	2-1/8"	3-7/8"	35 lbs.	100/box
AL-SH114	1-1/4"	3"	2"	4"	35 lbs.	100/box
AL-SH112	1-1/2"	3"	2"	4"	35 lbs.	100/box
AL-SH2	2"	4"	1-7/8"	4-5/8"	60 lbs.	100/box

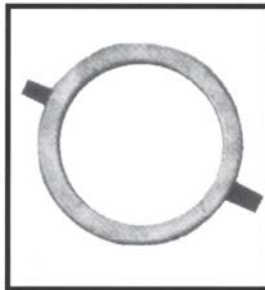

ALUMINUM RINGS (TAB WELD)

Item#	Size	Weld tab	Dia.	Wgt	Pk
AL-4R	1/2"	No	3-15/16"	22 lbs.	100/box
AL-4RNT*	1/2"	Yes	3-15/16"	22 lbs.	100/box
AL-5R	1/2"	No	4-15/16"	33 lbs.	100/box
AL-5RNT*	1/2"	Yes	4-15/16"	33 lbs.	100/box

* NT - No weld tabs



ALUMINUM BALLS

Item#	Size	Wgt.	Pk
AL-B34	3/4"	30 lbs.	500/box
AL-B100	1"	31 lbs.	500/box
AL-B112	1-1/2"	39 lbs.	100/box
AL-B200	2"	26 lbs.	60/box
AL-B212	2-1/2"	40 lbs.	25/box
AL-B300	3"	28 lbs.	20/box

DUCTILE IRON

Ductile iron is low-carbon cast iron that is annealed for high tensile strength and improved flexibility. Ductile iron can be shaped through cold working such as stamping, straightening, bending, and coining operations.

DUCTILE IRON BALL



DUCTILE BALLS			
Item#	Size	Pk	Wgt.
DUC-B34	3/4"	500/box	16 lbs.
DUC-B1	1"	200/box	30 lbs.
DUC-B112	1-1/2"	100/box	47 lbs.
DUC-B2	2"	30/box	33 lbs.
DUC-B3	3"	10/box	37 lbs.
DUC-B4	4"	4/box	53 lbs.

TEXTURED DUCTILE BALLS			
Item#	Size	Pk	Wgt.
DUC-TB136	1-9/16"	100/box	46 lbs.
DUC-TB196	1-3/4"	100/box	55 lbs.

DUCTILE IRON HANDRAIL BRACKETS



DUC-BH2305

For Flat Railings
 Extends 3" from Wall
 Packed 50 pcs/box
 Weight 56 lbs/box

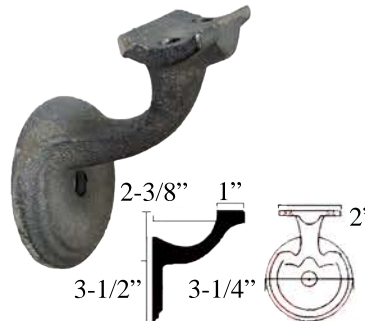

DUC-BH2306

For Pipe Railings
 Extends 3" from Wall
 Packed 50 pcs/box
 Weight 60 lbs/box

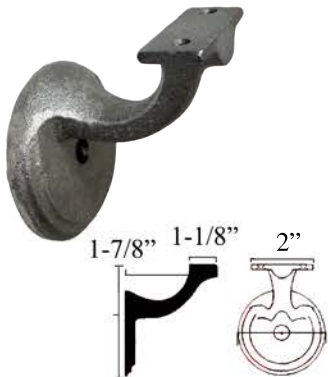

DUC-BH2381

For Flat Railings
 Extends 2-1/2" from Wall
 Packed 50 pcs/box
 Weight 32 lbs/box

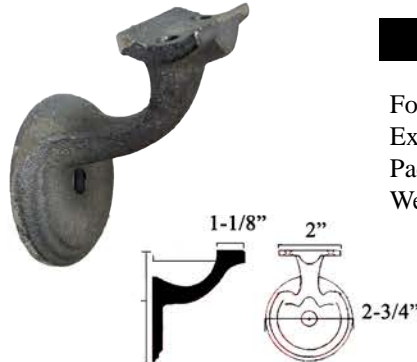

DUC-BH2382

For Pipe Railings
 Extends 2-1/2" from Wall
 Packed 50 pcs/box
 Weight 42 lbs/box

DUCTILE IRON BALUSTER

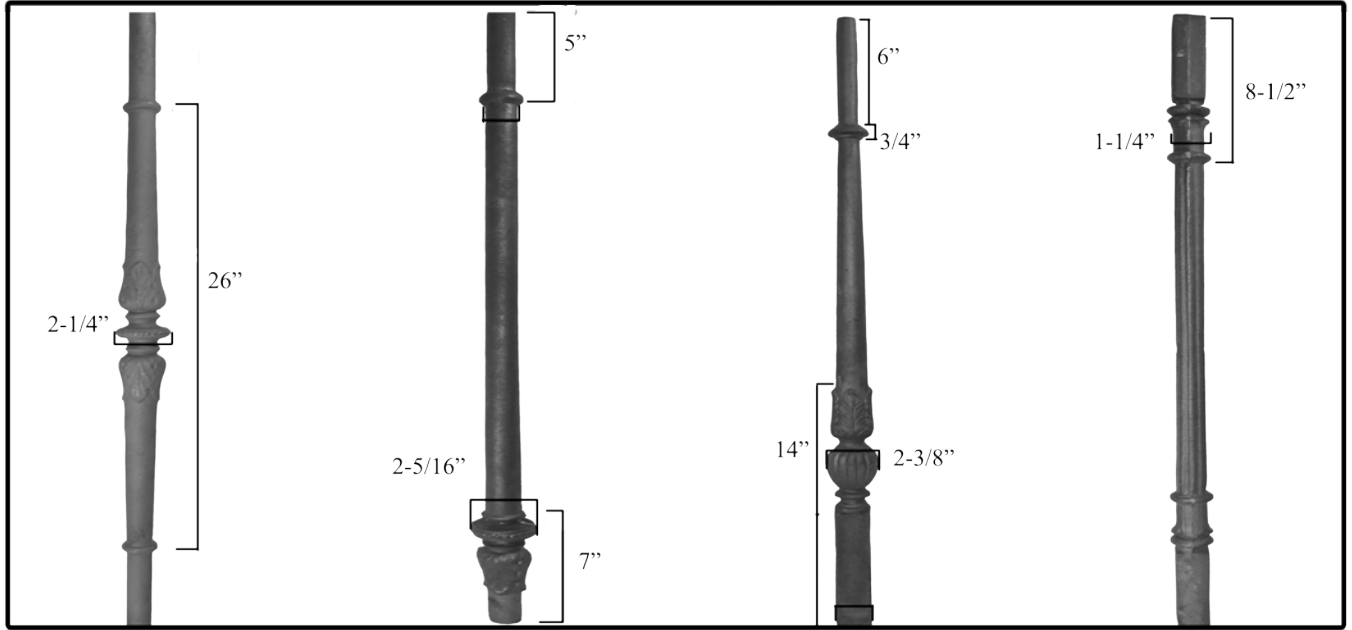

DUC-6505

Length: 36"
Post Dia.: 1"
Packed 4 pcs/bundle
Weight 48 lbs/bundle

DUC-6154

Length: 36-1/4"
Post Dia.: 1"
Packed 4 pcs/bundle
Weight 52 lbs/bundle

DUC-6533

Length: 36"
Post Dia.: 1"
Packed 4 pcs/bundle
Weight 52 lbs/bundle

DUC-6535

Length: 36-1/4"
Post Dia.: 1"
Packed 4 pcs/bundle
Weight 36 lbs/bundle

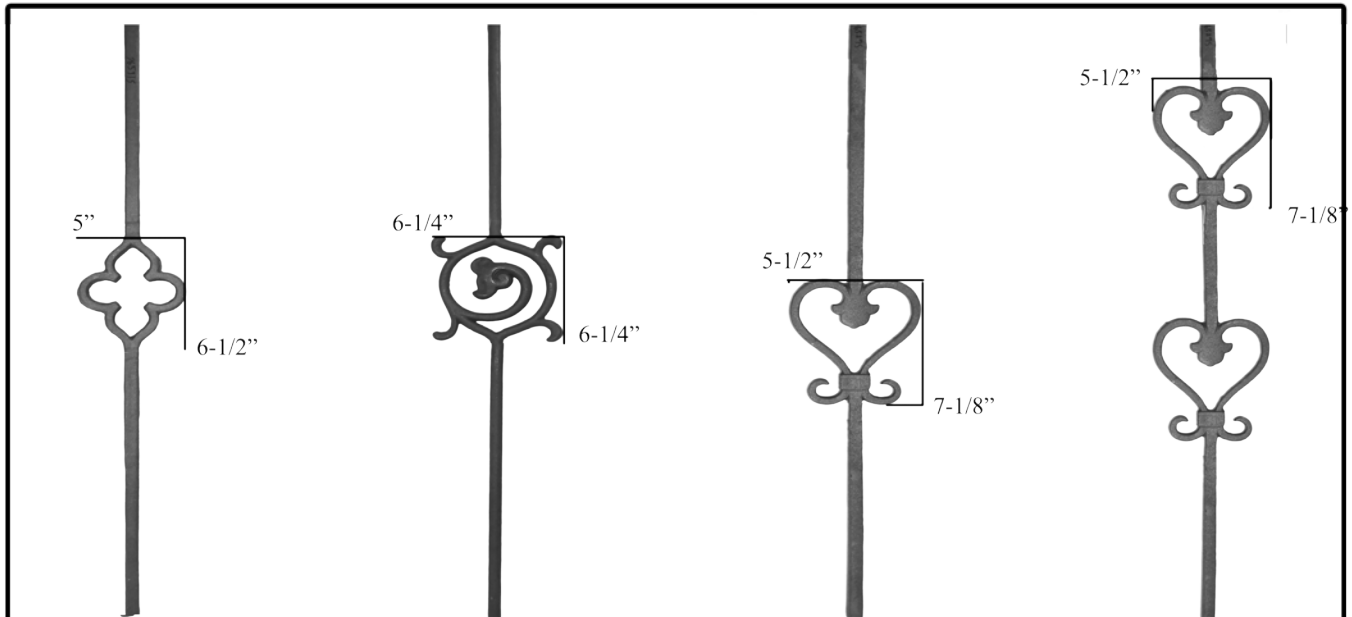

DUC-6531S

Picket: 5/8" Square
Length: 36"
Packed 5 pcs/bundle
Weight 21 lbs/bundle

DUC-6532S

Picket: 5/8" Square
Length: 36"
Packed 5 pcs/bundle
Weight 25 lbs/bundle

DUC-6529S

Picket: 5/8" Square
Length: 35-1/2"
Packed 5 pcs/bundle
Weight 25 lbs/bundle

DUC-6529D

Picket: 5/8" Square
Length: 36"
Packed 5 pcs/bundle
Weight 30 lbs/bundle

DUCTILE IRON PANELS

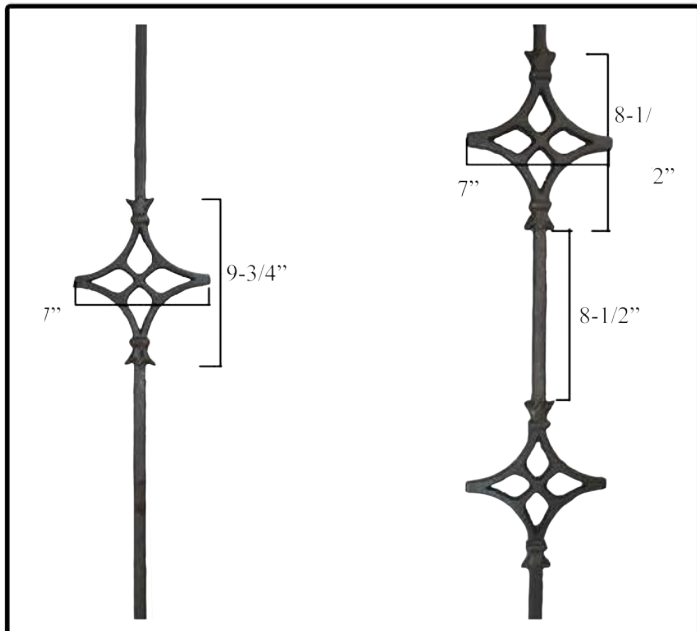

Ductile iron is sturdier due to higher tensile strength and improved flexibility, creating clear advantages over standard cast iron.

DUC-6528S

Length: 36-1/2"
Material: 5/8" Square
Width: 7"
Packed: 5 pcs/bundle
Weight: 18 lbs/bundle

DUC-6528D

Length: 36-1/2"
Material: 5/8" Square
Width: 7"
Packed: 5 pcs/bundle
Weight: 25 lbs/bundle



DUC-9508

Length: 27"
Width: 13-1/2"
Packed: 5 pcs/bundle
Weight: 55 lbs/bundle



DUC-9960

Length: 27"
Width: 12-1/2"
Packed: 5 pcs/bundle
Weight: 60 lbs/bundle



DUC-9579

Length: 27"
Width: 13-1/2"
Packed: 5 pcs/bundle
Weight: 66 lbs/bundle



DUC-9961

Length: 27"
Width: 13-1/2"
Packed: 5 pcs/bundle
Weight: 70 lbs/bundle

DUCTILE IRON SHOES



DUCTILE IRON SHOES (ROUND)

Item#	Size	Base	Height	Wgt.	Pk
DUC-SHR2	1/2"	1-3/16"	1"	18 lbs.	100/box
DUC-SHR3	3/8"	1-3/16"	1"	18 lbs.	100/box
DUC-SHR5	5/8"	1-3/8"	1-1/8"	28 lbs.	100/box



DUCTILE IRON SHOES (ROUND)

Item#	Hole	Base	Wgt.	Pk
DUC-SHR60	1/2"	1-3/16"	18 lbs.	100/box
DUC-SHR61	5/8"	1-5/16"	29 lbs.	100/box



DUCTILE IRON SHOES (SQUARE)

Item#	Hole	Base	Wgt.	Pk
DUC-SH362	1/2"	1-1/4"	20 lbs.	100/box
DUC-SH363	5/8"	1-1/4"	22 lbs.	100/box



DUCTILE IRON SHOES (SQUARE)

Item#	Hole	Base	Height	Wgt.	Pk
DUC-SHEE	1/2"	1-1/4"	7/8"	24 lbs.	150/box
DUC-SHGG	5/8"	1-1/4"	7/8"	24 lbs.	150/box
DUC-SH398	3/4"	1-7/16"	7/8"	19 lbs.	100/box
DUC-SHMM	1"	1-3/4"	1-1/8"	33 lbs.	100/box

DUCTILE IRON RAILENDS



DUCTILE CHANNEL RAILEND

Item#	Fit	Width	Length	Wgt	Pk
DUC-RE100CC	1-3/4"	4-1/2"	4-1/2"	25 lbs.	50/box
DUC-RE125CC	2-1/4"	4-5/8"	4-5/8"	22 lbs.	40/box



DUCTILE LATERAL RAILEND

Item#	Fit	Width	Length	Wgt	Pk
DUC-RE4429C	1-3/4"	6"	6"	29 lbs.	30/box
DUC-RE4441C	2-1/4"	6-1/8"	6-1/8"	30 lbs.	20/box



DUCTILE TERMINAL RAILEND

Item#	Fit	Width	Length	Wgt	Pk
DUC-RE4429E	1-3/4"	3-3/4"	2-1/4"	29 lbs.	30/box
DUC-RE4441E	2-1/4"	4-3/4"	3-1/8"	33 lbs.	25/box

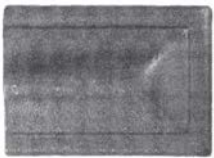

DUCTILE RAILEND CAP

Item#	Fit	Width	Length	Wgt	Pk
DUC-RE4429N	1-3/4"	2-1/2"	1-3/4"	28 lbs.	80/box
DUC-RE4441N	2-1/4"	2-1/2"	2-1/4"	23 lbs.	50/box



DUCTILE LAMBS TONGUE

Item#	Fit	Width	Length	Wgt	Pk
DUC-RE4429B	1-3/4"	4"	5"	28 lbs.	20/box



DUCTILE LAMBS TONGUE

Item#	Fit	Width	Length	Wgt	Pk
DUC-RE4429S	1-3/4"	5"	4-3/4"	28 lbs.	20/box
DUC-RE4441S	2-1/4"	5"	4-3/4"	52 lbs.	20/box

DUCTILE IRON RAILENDS



DUCTILE CORNER PIECE

Item#	Fit	Width	Length	Wgt	Pk
DUC-RE4429L	1-3/4"	3-7/8"	3-7/8"	38 lbs.	50/box



DUCTILE CENTER PIECE

Item#	Fit	Width	Length	Wgt	Pk
DUC-RE4429T	1-3/4"	5-1/4"	2-1/4"	30 lbs.	40/box



DUCTILE MOLDED VOLUTE

Item#	Fit	Width	Length	Wgt	Pk
DUC-RE4429V	1-3/4"	4-5/8"	1-3/4"	26 lbs.	25/box
DUC-RE4441V	2-1/4"	4-5/8"	2-1/4"	32 lbs.	20/box



DUC-4429V Railend shown, mounted on HD-BH300.

TWISTED BALUSTERS



IND-48-1C

Mtl: 1/2" Sq. Bar
 H: 39"
 Weight: 2.6 lbs.
 Packed: 5 pcs/bundle



IND-48-1LC

Mtl: 1/2" Sq. Bar
 H: 47"
 Weight: 3.3 lbs.
 Packed: 5 pcs/bundle



IND-48-2C

Mtl: 1/2" Sq. Bar
 H: 39"
 Weight: 2.4 lbs.
 Packed: 5 pcs/bundle



IND-48-2LC

Mtl: 1/2" Sq. Bar
 H: 47"
 Weight: 3.2 lbs.
 Packed: 5 pcs/bundle



IND-48-3C

Mtl: 1/2" Sq. Hammered
 H: 39"
 Weight: 2.4 lbs.
 Packed: 5 pcs/bundle



IND-48-3LC

Mtl: 1/2" Sq. Hammered
 H: 47"
 Weight: 3.4 lbs.
 Packed: 5 pcs/bundle



IND-48-4C

Mtl: 1/2" Sq. Hammered
 H: 39"
 Weight: 3.4 lbs.
 Packed: 5 pcs/bundle



IND-48-4LC

Mtl: 1/2" Sq. Hammered
 H: 47"
 Weight: 3.2 lbs.
 Packed: 5 pcs/bundle

TWISTED BALUSTERS



IND-49-3C

Mtl: 1/2" Sq. Bar
 H: 39-1/2"
 W: 7"
 Weight: 6 lbs.
 Packed: 10 pcs/bundle



IND-50-5C

Mtl: 1/2" Sq. Bar
 H: 39-1/2"
 W: 1-1/4"
 Weight: 2.1 lbs.
 Packed: 20 pcs/bundle



IND-50-5LC

Mtl: 1/2" Sq. Bar
 H: 47"
 W: 1-1/4"
 Weight: 3.5 lbs.
 Packed: 20 pcs/bundle



IND-50-6C

Mtl: 1/2" Sq. Bar
 H: 39-1/2"
 W: 1-1/4"
 Weight: 2.2 lbs.
 Packed: 20 pcs/bundle



IND-50-6LC

Mtl: 1/2" Sq. Bar
 H: 47"
 W: 1-1/4"
 Weight: 2.9 lbs.
 Packed: 20 pcs/bundle



IND-50-7C

Mtl: 1/2" Sq. Bar
 H: 39"
 W: 5-1/2"
 Weight: 2.8 lbs.
 Packed: 12 pcs/bundle



IND-50-7LC

Mtl: 1/2" Sq. Bar
 H: 47"
 W: 5-1/2"
 Weight: 3.5 lbs.
 Packed: 12 pcs/bundle



IND-50-8C

Mtl: 1/2" Sq. Bar
 H: 39-1/2"
 W: 5-1/2"
 Weight: 3.4 lbs.
 Packed: 12 pcs/bundle

TWISTED BALUSTERS



IND-50-8LC

Mtl: 1/2" Sq. Bar
 H: 47"
 W: 5-1/2"
 Weight: 4.1 lbs.
 Packed: 12 pcs/bundle



IND-51-3C

Mtl: 1/2" Sq. Bar
 H: 35-1/2"
 W: 11-3/4"
 Weight: 8.5 lbs.
 Packed: 10 pcs/bundle



IND-52-2C

Double Grooved
 Mtl: 1/2" Sq. Bar
 H: 35-1/2" W: 9-1/4"
 Weight: 5.5 lbs.
 Packed: 8 pcs/bundle



IND-53-1C

Mtl: 1/2" Sq. Bar
 H: 35-1/2"
 W: 9-1/4"
 Weight: 4.5 lbs.
 Packed: 6 pcs/bundle



IND-52-3C

Double Grooved
 Mtl: 1/2" Sq. Bar
 H: 35-1/2"
 Weight: 2.5 lbs.
 Packed: 20 pcs/bundle



IND-53-3C

Mtl: 1/2" Sq. Bar
 H: 39-1/2"
 Weight: 2.5 lbs.
 Packed: 20 pcs/bundle



IND-53-347C

Mtl: 1/2" Sq. Bar
 H: 47"
 Weight: 3.0 lbs.
 Packed: 20 pcs/bundle



IND-65-8C

Mtl: 1/2" Sq. Bar
 H: 39-1/2"
 Weight: 2.5 lbs.
 Packed: 20 pcs/bundle



IND-65-847LC

Mtl: 1/2" Sq. Bar
 H: 47"
 Weight: 4 lbs.
 Packed: 20 pcs/bundle

STAIR & RAIL BALUSTER



IND-52-A-4SC

Mtl: 1/2" x 1/4" Bar
 H: 39-1/2"
 W: 7-1/4"
 Weight: 4 lbs.
 Packed: 10 pcs/bundle



IND-52-4SLC

Mtl: 1/2" x 1/4" Bar
 H: 44-1/4"
 W: 7-1/4"
 Weight: 4.5 lbs.
 Packed: 10 pcs/bundle



IND-60-3C

Mtl: 1/2" Sq. Bar
 H: 35-1/2"
 W: 5-1/4"
 Weight: 4 lbs.
 Packed: 10 pcs/bundle



IND-64-B-2C

Mtl: 1/2" Sq. Bar
 H: 35-1/2"
 W: 8-5/8"
 Weight: 4 lbs.
 Packed: 5 pcs/bundle



IND-64-F-3C

Mtl: 1/2" Sq. Bar
 H: 39"
 W: 1-1/4"
 Weight: 3 lbs.
 Packed: 20 pcs/bundle



IND-64-F-3LC

Mtl: 1/2" Sq. Bar
 H: 47"
 Weight: 3.7 lbs.
 Packed: 20 pcs/bundle



IND-64-F-5C

Mtl: 1/2" Sq. Bar
 H: 39-1/2"
 Weight: 3.7 lbs.
 Packed: 20 pcs/bundle

STAIR & RAIL BALUSTER



IND-64-F-5LC

Mtl: 5/8" Sq. Bar
H: 47"
Weight: 3.7 lbs.
Packed: 20 pcs/bundle



IND-64-F-9C

Mtl: 9/16" Sq. Bar
H: 35-1/2"
W: 4-1/4"
Weight: 4.2 lbs.
Packed: 12 pcs/bundle



IND-64-F-9DC

Double Faced
Mtl: 9/16" Sq. Bar
H: 35-1/2"
W: 4-1/4"
Weight: 4.5 lbs.
Packed: 12 pcs/bundle



IND-64-I-2C

Mtl: 9/16" Sq. Bar
H: 39-1/4"
Weight: 3.6 lbs.
Packed: 12 pcs/bundle



IND-64-I-2LC

Mtl: 9/16" Sq. Bar
H: 47"
Weight: 4.5 lbs.
Packed: 12 pcs/bundle



IND-64-I-3C

Mtl: 9/16" Sq. Bar
H: 39-1/2"
Weight: 3.3 lbs.
Packed: 12 pcs/bundle



IND-64-I-3LC

Mtl: 9/16" Sq. Bar
H: 47"
Weight: 4.2 lbs.
Packed: 12 pcs/bundle

STAIR & RAIL BALUSTERS



IND-70-D-1C

Mtl: 9/16" Sq. Bar
H: 39" Weight: 3 lbs.
Packed: 20 pcs/bundle

IND-70-D-1LC
47" Version



IND-541-2C

Mtl: 1/2" Dia. Rnd
H: 35-1/2"
W: 13-1/2"
Weight: 12 lbs.
Packed: 4 pcs/bundle



IND-12040

4-Side Grooved Edge
Mtl: 5/16" Dia. Rnd
H: 36" W: 9"
Weight: 6.3 lbs.
Packed: 5 pcs/bundle



IND-12041

Mtl: 5/16 x 5/8"
H: 36"
W: 7-1/2"
Weight: 6.6 lbs.
Packed: 5 pcs/bundle



IND-12042

Mtl: 5/16" x 5/8"
H: 36"
W: 9"
Weight: 5.5 lbs.
Packed: 8 pcs/bundle



IND-12043

Mtl: 1/2" Sq. Bar
H: 35-1/2"
W: 7"
Weight: 4.4 lbs.
Packed: 10 pcs/bundle



IND-12027

Mtl: 1/2" Sq. Bar
H: 35-1/2"
W: 5"
Weight: 4 lbs.
Packed: 10 pcs/bundle

STAIR & RAIL BALUSTERS



IND-12026

Mtl: 5/16 x 5/8"
 H: 36"
 W: 7-1/2"
 Weight: 6.6 lbs.
 Packed: 5 pcs/bundle



IND-12065

Mtl: 5/16" x 5/8"
 H: 36"
 W: 9"
 Weight: 5.5 lbs.
 Packed: 8 pcs/bundle



IND-12006

Mtl: 1/2" Sq. Bar
 H: 35-1/2"
 W: 7"
 Weight: 4.4 lbs.
 Packed: 10 pcs/bundle



IND-12008

Mtl: 1/2" Sq. Bar
 H: 35-1/2"
 W: 5"
 Weight: 4 lbs.
 Packed: 10 pcs/bundle



IND-12704

Mtl: 5/16 x 5/8"
 H: 36"
 W: 7-1/2"
 Weight: 6.6 lbs.
 Packed: 5 pcs/bundle



IND-12704DB

Mtl: 5/16" x 5/8"
 H: 36"
 W: 9"
 Weight: 5.5 lbs.
 Packed: 8 pcs/bundle



IND-12705

Mtl: 1/2" Sq. Bar
 H: 35-1/2"
 W: 7"
 Weight: 4.4 lbs.
 Packed: 10 pcs/bundle



IND-12905

Mtl: 1/2" Sq. Bar
 H: 35-1/2"
 W: 5"
 Weight: 4 lbs.
 Packed: 10 pcs/bundle

STAIR & RAIL BALUSTERS



IND-12908

Mtl: 1/2" x 5/8"
H: 39-1/4"
Weight: 33 lbs.
Packed: 10 pcs/bundle



IND-12068

Mtl: 9/16" Sq. Bar
H: 39-1/8"
W: 6"
Weight: 44 lbs.
Packed: 10 pcs/bundle



IND-108-A-1

Mtl: 1/2" Sq. Hammered
H: 39-1/2"
Weight: 30 lbs.
Packed: 10 pcs/bundle



IND-108-A-2

Mtl: 1/2" Hammered
H: 39-1/2"
Weight: 37 lbs.
Packed: 10 pcs/bundle



IND-105-1C

Mtl: 1/2" Sq. Hammered
H: 39-5/16"
Weight: 33 lbs.
Packed: 10 pcs/bundle



IND-105-1LC

Mtl: 1/2" Sq. Hammered
H: 47"
Weight: 34 lbs.
Packed: 10 pcs/bundle



IND-105-2C

Mtl: 1/2" Sq. Hammered
H: 39-5/16"
Weight: 33 lbs.
Packed: 10 pcs/bundle



IND-105-2LC

Mtl: 1/2" Sq. Hammered
H: 47"
Weight: 35 lbs.
Packed: 10 pcs/bundle

STAIR & RAIL BALUSTERS



IND-109-3C

Mtl: 1/2" Sq. Hammered
 H: 39-1/4"
 Weight: 33 lbs./bundle
 Packed: 10 pcs/bundle



IND-64-L-3C

Mtl: 1/2" Dia.
 H: 35-1/2"
 Weight: 23 lbs./bundle
 Packed: 10 pcs/bundle



IND-64-L-4C

Mtl: 1/2" Dia.
 H: 35-1/2"
 Weight: 23 lbs./bundle
 Packed: 10 pcs/bundle



IND-64-R-4C

Mtl: 1/2" Dia.
 H: 39-1/2"
 Weight: 37 lbs./bundle
 Packed: 10 pcs/bundle



IND-64-R-3C

Mtl: 1/2" Dia.
 H: 39-1/4"
 Weight: 27 lbs./bundle
 Packed: 10 pcs/bundle



IND-12703

Mtl: 3/8" Sq.
 H: 39-1/2"
 Weight: 20 lbs./bundle
 Packed: 10 pcs/bundle



IND-576-2C

Mtl: 1/2" Dia.
 H: 35-1/2"
 Weight: 25 lbs./bundle
 Packed: 20 pcs/bundle



IND-576-4C

Mtl: 1/2" Dia.
 H: 35-1/2"
 Weight: 25 lbs./bundle
 Packed: 20 pcs/bundle

ROUND BALUSTERS



IND-12707

Mtl: 9/16 Dia. Hammered
H: 39-5/16"
Weight: 33 lbs./bundle
Packed: 10 pcs/bundle



IND-12710

Mtl: 1/2" Dia. Hammered
H: 39-5/16"
Weight: 44 lbs./bundle
Packed: 10 pcs/bundle



IND-12710S

Mtl: 1/2" Dia. Hammered
H: 39-5/16"
Weight: 30 lbs./bundle
Packed: 10 pcs/bundle



IND-604-7C

Mtl: 5/8" Dia. Hammered
H: 35-1/4"
Weight: 30 lbs./bundle
Packed: 10 pcs/bundle



IND-98-1C

Mtl: 9/16" Sq. Hammered
H: 39-1/2"
Weight: 50 lbs./bundle
Packed: 10 pcs/bundle



IND-604-6C

Mtl: 5/8" Dia. Hammered
H: 35-1/4"
Weight: 40 lbs./bundle
Packed: 10 pcs/bundle

STEEL TUBE COMPONENTS



IND-154-2C

Mtl: 1-1/4" Dia.
H: 6"
Weight: 15 lbs./bag
Packed: 50 pcs/bag

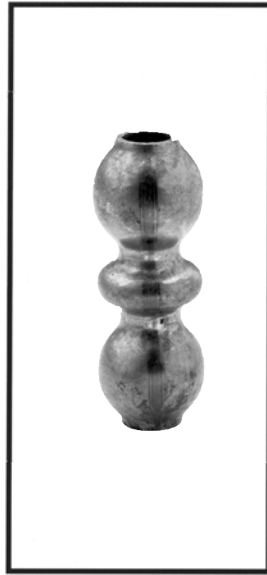

IND-155-1C

Mtl: 1-1/4" Dia.
H: 3-3/4"
Weight: 10 lbs./bag
Packed: 50 pcs/bag



IND-155-2C

Mtl: 1-1/4" Dia.
H: 2-1/2"
Weight: 10 lbs./bag
Packed: 50 pcs/bag



IND-155-4C

Mtl: 1-1/4" Dia.
H: 3/4"
Weight: 5 lbs./bag
Packed: 50 pcs/bag

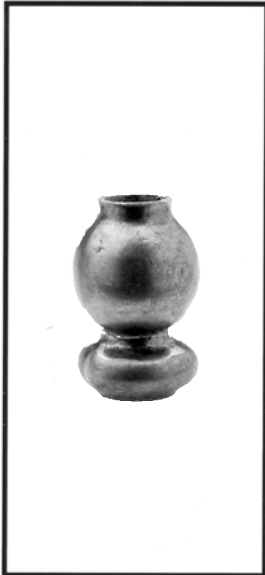

IND-155-3C

Mtl: 1-1/4" Dia.
H: 1-7/8"
Weight: 10 lbs./bag
Packed: 50 pcs/bag

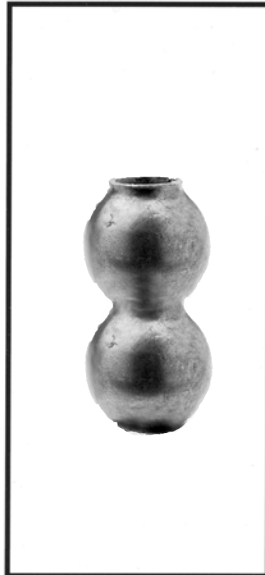

IND-155-6C

Mtl: 1-1/4" Dia.
H: 2-1/2"
Weight: 10 lbs./bag
Packed: 50 pcs/bag



IND-148-1C

Mtl: 1-1/4" Dia.
H: 35-1/2"
Weight: 40 lbs./bundle
Packed: 20 pcs/bundle



IND-148-2C

Mtl: 1-1/4" Dia.
H: 35-1/2"
Weight: 40 lbs./bundle
Packed: 20 pcs/bundle

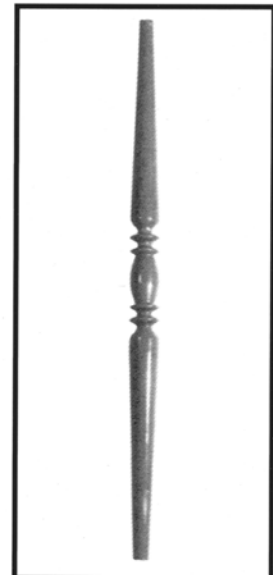

IND-149-1C

Mtl: 1-1/4" Dia.
H: 35-1/2"
Weight: 40 lbs./bundle
Packed: 20 pcs/bundle

FORGED NEWEL POSTS



IND-14003

Mtl: 1" Sq Hammered
H: 47"
Weight: 15 lbs.
Packed: Each



IND-14008

Mtl: 1" Sq Hammered
H: 47"
Weight: 12.5 lbs.
Packed: Each



IND-14016

Mtl: 1" Sq Hammered
H: 47"
Weight: 14 lbs.
Packed: Each



IND-14048

Mtl: 1" Sq Hammered
H: 47"
Weight: 8.9 lbs.
Packed: Each

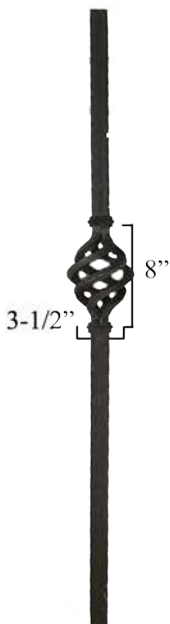

IND-14049

Mtl: 1" Sq Hammered
H: 47"
Weight: 13.5 lbs.
Packed: Each



IND-64-F-1C

Mtl: 1" Sq Hammered
H: 47"
Weight: 13 lbs.
Packed: Each



IND-50-25

Mtl: 1" Sq Hammered
H: 47"
Weight: 13 lbs.
Packed: Each



IND-53-25

Mtl: 1" Sq Hammered
H: 47"
Weight: 13 lbs.
Packed: Each

BALCONY ELEMENTS



IND-64-H-10

Mtl: 9/16" Sq. Bar
 H: 35-7/16"
 W: 1-3/16
 Weight: 15.5 lbs
 Packed: 5 pcs/bundle



IND-47-10

Mtl: 9/16" Sq. Bar
 H: 35-1/2"
 Weight: 15 lbs
 Packed: 5 pcs/bundle



IND-44-12

Hammered Edge
 Mtl: 1-9/16" x 5/16"
 H: 39-3/8"
 Weight: 38.5 lbs
 Packed: 5 pcs/bundle



IND-47-11

Hammered Edge
 Mtl: 9/16" Sq. Bar
 H: 35-1/2"
 Weight: 15.5 lbs
 Packed: 5 pcs/bundle

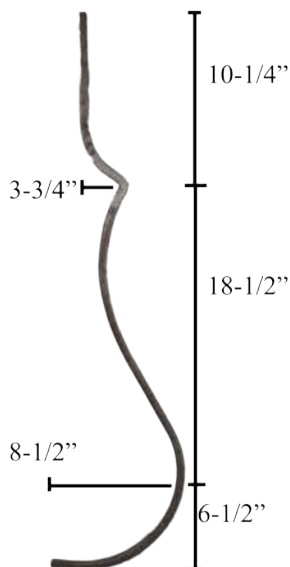

IND-70-D-5

Mtl: 9/16" Sq. Bar
 H: 35-7/16"
 Weight: 17 lbs
 Packed: 5 pcs/bundle



IND-47-7

Hammered Edge
 Mtl: 9/16" Sq.
 H: 35-7/16"
 Weight: 15 lbs
 Packed: 5 pcs/bundle



47-10 depicted.

TUBING SCROLLS



IND-90-T1

Fishtail Style Scroll
Mtl: 3/4" Tubing
H: 8-1/4"
W: 5-1/8"



IND-90-T5

Fishtail Style Scroll
Mtl: 3/4" Tubing
H: 26-5/8"
W: 11-3/8"



IND-90-T2

Fishtail Style Scroll
Mtl: 3/4" Tubing
H: 10-7/8"
W: 5-1/4"



IND-90-T6

Fishtail Style Scroll
Mtl: 3/4" Tubing
H: 30"
W: 11"



IND-90-T3

Fishtail Style Scroll
Mtl: 3/4" Tubing
H: 19-1/2"
W: 9-3/4"



IND-90-T4

Fishtail Style Scroll
Mtl: 3/4" Tubing
H: 30"
W: 11"



IND-90-T7

Fishtail Style Scroll
Mtl: 3/4" Tubing
H: 29"
W: 9-3/4"

TUBING SCROLLS



IND-90-T8

Steel Tubing Scrolls
Scrolled Ends
Mtl: 3/4" Tubing
H: 13-3/8"
W: 35-1/2"



IND-90-T9

Steel Tubing Scrolls
Scrolled Ends
Mtl: 3/4" Tubing
H: 18-3/4"
W: 46-3/4"



IND-90-T10

Steel Tubing Scrolls
Scrolled Ends
Mtl: 3/4" Tubing
H: 15"
W: 35-3/4"



IND-90-T11

Steel Tubing Scrolls
Scrolled Ends
Mtl: 3/4" Tubing
H: 35-3/4"
W: 25-3/8"

SNAP-ON SCROLLS

IND-35-1C

Mtl: 1/2" x 1/4"
H: 8-1/16"
W: 17-1/2"
Weight: 27 lbs./bundle
Packed: 10 pcs/bundle



IND-37-3C

Mtl: 1/2" x 1/4"
H: 3-3/4"
W: 3-3/4"
Weight: 24 lbs./bundle
Packed: 40 pcs/box



IND-35-2C

Mtl: 1/2" x 1/4"
H: 13-1/2"
W: 8"
Weight: 21 lbs./bundle
Packed: 10 pcs/bundle



IND-37-4C

Mtl: 1/2" x 1/4"
H: 6-1/2"
W: 5-1/4"
Weight: 34 lbs./bundle
Packed: 40 pcs/bundle



IND-36-1C

Mtl: 1/2" x 1/4"
H: 10"
W: 8-5/8"
Weight: 17 lbs./bundle
Packed: 10 pcs/bundle



IND-36-2C

Mtl: 1/2" x 1/4"
H: 15"
W: 9"
Weight: 28 lbs./bundle
Packed: 10 pcs/bundle



36-1C and 36-2C depicted.

FISH TAIL SCROLLS

IND-80-A-1C

Mtl: 1/2" x 1/4"
H: 10-5/8"
W: 4-1/4"
Weight: 60 lbs./bundle
Packed: 80 pcs/bundle



IND-80-A-11C

Mtl: 1/2" x 1/4"
H: 5-7/8"
W: 2-1/2"
Weight: 40 lbs./bundle
Packed: 100 pcs/bundle



IND-80-A-3C

Mtl: 1/2" x 1/4"
H: 4-1/4"
W: 2-1/4"
Weight: 30 lbs./bundle
Packed: 100 pcs/bundle



IND-80-A-12C

Mtl: 1/2" x 1/4"
H: 7-1/2"
W: 2-3/4"
Weight: 50 lbs./bundle
Packed: 100 pcs/bundle



IND-80-A-9C

Mtl: 1/2" x 1/4"
H: 4-1/8"
W: 2-3/4"
Weight: 40 lbs./bundle
Packed: 100 pcs/bundle



IND-80-A-13C

Mtl: 1/2" x 1/4"
H: 13"
W: 5"
Weight: 50 lbs./bundle
Packed: 50 pcs/bundle



IND-80-A-10C

Mtl: 1/2" x 1/4"
H: 5-1/2"
W: 3-3/4"
Weight: 40 lbs./bundle
Packed: 100 pcs/bundle



IND-80-A-15C

Mtl: 1/2" x 1/4"
H: 15"
W: 5"
Weight: 45 lbs./bundle
Packed: 40 pcs/bundle



FISH TAIL SCROLLS

IND-80-A-17C

Mtl: 1/2" x 1/4"
H: 17"
W: 7"
Weight: 42 lbs./bundle
Packed: 30 pcs/bundle



IND-80-A-30C

Mtl: 1/2" x 1/4"
H: 10-1/2"
W: 3"
Weight: 39 lbs./bundle
Packed: 50 pcs/bundle



IND-80-A-22C

Mtl: 1/2" x 1/4"
H: 8-1/2"
W: 4"
Weight: 45 lbs./bundle
Packed: 50 pcs/bundle



IND-80-A-33C

Mtl: 1/2" x 1/4"
H: 11"
W: 6-1/2"
Weight: 42 lbs./bundle
Packed: 30 pcs/bundle



IND-80-A-23C

Mtl: 1/2" x 1/4"
H: 10-1/2"
W: 4-1/2"
Weight: 50 lbs./bundle
Packed: 50 pcs/bundle



IND-84-7C

Mtl: 3/4" x 1/4"
H: 8-7/8"
W: 5-7/8"
Weight: 48 lbs./bundle
Packed: 30 pcs/bundle



IND-80-A-24C

Mtl: 1/2" x 1/4"
H: 17"
W: 6-1/2"
Weight: 45 lbs./bundle
Packed: 30 pcs/bundle



"Different scrolls can be combined to create a custom and unique aesthetic."

SCROLLS WITH LEAVES



IND-61121

Mtl: 1/2" x 1/4"
 H: 16-1/2"
 W: 8-1/2"
 Weight: 25 lbs/bundle
 Packed: 10 pcs/bundle



IND-61122

Mtl: 1/2" x 1/4"
 H: 16-1/2"
 W: 8-1/2"
 Weight: 25 lbs/box
 Packed: 10 pcs/bundle



IND-61135

Mtl: 1/2" x 1/4"
 H: 30"
 W: 12-1/2"
 Weight: 17.5 lbs/bundle
 Packed: 5 pcs/bundle



IND-61136

Mtl: 1/2" x 1/4"
 H: 30"
 W: 12-1/2"
 Weight: 17.5 lbs/box
 Packed: 5 pcs/bundle



IND-61157

Mtl: 1/2" x 1/4"
 H: 5"
 W: 10-1/4"
 Weight: 5 lbs/bundle
 Packed: 5 pcs/bundle



IND-61158

Mtl: 1/2" x 1/4"
 H: 5"
 W: 10-1/4"
 Weight: 5 lbs/bundle
 Packed: 5 pcs/bundle



IND-93-4C

Mtl: 1/2" x 1/4"
 H: 13-3/4"
 W: 9"
 Weight: 25 lbs/box
 Packed: 20 pcs/bundle



IND-94-3C

Mtl: 1/2" x 1/4"
 H: 7-7/8"
 W: 5-7/8"
 Weight: 25 lbs/box
 Packed: 20 pcs/bundle

TIGHT CURL SCROLLS (HAMMERED)

IND-62001

Mtl: 5/16" x 5/8"
H: 5"
W: 3"
Weight: 66 lbs/box
Packed: 100 pcs/box



IND-62006

Mtl: 5/16" x 5/8"
H: 11-1/2"
W: 4-7/8"
Weight: 29 lbs/box
Packed: 20 pcs/box



IND-62002

Mtl: 5/16" x 5/8"
H: 9"
W: 6"
Weight: 37 lbs/box
Packed: 25 pcs/box



IND-62007

Mtl: 5/16" x 5/8"
H: 11-1/2"
W: 5"
Weight: 68 lbs/box
Packed: 40 pcs/box



IND-62003

Mtl: 5/16" x 5/8"
H: 4-1/2"
W: 2-3/8"
Weight: 66 lbs/box
Packed: 100 pcs/box



IND-62008

Mtl: 5/16" x 5/8"
H: 5"
W: 14"
Packed: 40 pcs/bundle
Weight: 48 lbs/bundle



IND-62004

Mtl: 5/16" x 5/8"
H: 7-1/4"
W: 3-1/2"
Weight: 53 lbs/box
Packed: 50 pcs/box



IND-62005

Mtl: 5/16" x 5/8"
H: 10-1/2"
W: 4-1/2"
Weight: 36 lbs/box
Packed: 20 pcs/box



IND-64022

Smooth
Mtl: 5/16" x 5/8"
H: 14-1/2"
W: 4"
Weight: 37.5 lbs/box
Packed: 25 pcs/box

TIGHT CURL SCROLLS (EDGE GROOVED)



IND-61001

Mtl: 5/16" x 5/8"
H: 3-1/8"
W: 5-1/8"
Weight: 70 lbs./box
Packed 80 pcs/box



IND-61005

Mtl: 5/16" x 5/8"
H: 10-3/8"
W: 4-1/2"
Weight: 35 lbs./box
Packed 20 pcs/box



IND-61002

Mtl: 5/16" x 5/8"
H: 8-7/8"
W: 5-7/8"
Weight: 37 lbs./box
Packed 25 pcs/box



IND-61006

Mtl: 5/16" x 5/8"
H: 8-5/8"
W: 4-3/4"
Weight: 38 lbs./box
Packed 30 pcs/box



IND-61003

Mtl: 5/16" x 5/8"
H: 4-1/2"
W: 2-3/8"
Weight: 65 lbs./box
Packed 100 pcs/box



IND-61007

Mtl: 5/16" x 5/8"
H: 11-7/16"
W: 4-3/4"
Weight: 29 lbs./box
Packed 20 pcs/box



IND-61004

Mtl: 5/16" x 5/8"
H: 7"
W: 3-9/16"
Weight: 52 lbs./box
Packed 50 pcs/box



IND-61008

Mtl: 5/16" x 5/8"
H: 14-1/4"
W: 4-3/4"
Weight: 68 lbs./box
Packed 40 pcs/box

SCROLLS WITH LEAVES (EDGE GROOVED)



IND-61034

Mtl: 5/16" x 5/8"
H: 12-1/2"
W: 9-1/2"
Weight: 2 lbs.
Packed 25 pcs/box



IND-61035

Mtl: 5/16" x 5/8"
H: 12-1/2"
W: 9-1/2"
Weight: 2 lbs.
Packed 25 pcs/box



IND-61039

Mtl: 5/16" x 5/8"
H: 15-3/4"
W: 9-1/2"
Weight: 2.8 lbs.
Packed 20 pcs/box



IND-61040

Mtl: 5/16" x 5/8"
H: 15-3/4"
W: 9-1/2"
Weight: 2.8 lbs.
Packed 20 pcs/box



IND-61041

Mtl: 5/16" x 5/8"
H: 12-1/2"
W: 7-1/8"
Weight: 2.1 lbs.
Packed 25 pcs/box



IND-61042

Mtl: 5/16" x 5/8"
H: 12-1/2"
W: 7-1/8"
Weight: 2.1 lbs.
Packed 25 pcs/box



IND-61048

Mtl: 5/16" x 5/8"
H: 8-1/4"
W: 5-1/2"
Weight: 1.32 lbs./box
Packed 40 pcs/box



IND-61049

Mtl: 5/16" x 5/8"
H: 8-1/4"
W: 5-1/2"
Weight: 1.3 lbs./box
Packed 40 pcs/box



IND-61051

Mtl: 5/16" x 5/8"
H: 8-5/8"
W: 5-3/4"
Weight: 1.4 lbs./box
Packed 40 pcs/box



IND-61052

Mtl: 5/16" x 5/8"
H: 8-5/8"
W: 5-3/4"
Weight: 1.4 lbs./box
Packed 40 pcs/box

ROUND BAR SCROLLS



IND-94-F-3C

Mtl: 1/2" Dia. Bar
H: 31-1/2"
W: 19-1/4"
Weight: 27 lbs./bundle
Packed 5 pcs/bundle



IND-94-F-4C

Mtl: 1/2" Dia. Bar
H: 31-1/2"
W: 19-1/4"
Weight: 27 lbs./bundle
Packed 5 pcs/bundle



IND-94-F-5C

Mtl: 1/2" Dia. Bar
H: 38-1/4"
W: 16-1/2"
Weight: 30 lbs./bundle
Packed 5 pcs/bundle



IND-94-F-6C

Mtl: 1/2" Dia. Bar
H: 38-1/4"
W: 16-1/2"
Weight: 30 lbs./bundle
Packed 5 pcs/bundle



IND-94-E-5C

Mtl: 1/2" Dia. Bar
H: 24-1/2"
W: 16-1/8"
Weight: 22 lbs./bundle
Packed 5 pcs/bundle



IND-94-E-6C

Mtl: 1/2" Dia. Bar
H: 24-1/2"
W: 16-1/8"
Weight: 22 lbs./bundle
Packed 5 pcs/bundle

ROUND BAR SCROLLS



IND-94-C-11C

Mtl: 1/2" Dia. Bar
H: 14-1/2"
W: 13"
Weight: 35 lbs./bundle
Packed: 10 pcs/bundle



IND-94-C-12C

Mtl: 1/2" Dia. Bar
H: 14-1/2"
W: 13"
Weight: 35 lbs./bundle
Packed: 10 pcs/bundle



IND-94-E-1C

Mtl: 1/2" Dia. Bar
H: 17-1/4"
W: 19-1/4"
Weight: 24 lbs./bundl-
Packed: 10 pcs/bundle



IND-94-E-2C

Mtl: 1/2" Dia. Bar
H: 17-1/4"
W: 19-1/4"
Weight: 24 lbs./bundle
Packed: 10 pcs/bundle



IND-94-E-3C

Mtl: 1/2" Dia. Bar
H: 21-1/4"
W: 12-1/4"
Weight: 15 lbs./bundle
Packed: 5 pcs/bundle



IND-94-E-4C

Mtl: 1/2" Dia. Bar
H: 21-1/4"
W: 12-1/4"
Weight: 15 lbs./bundle
Packed: 5 pcs/bundle

ROSETTE DESIGNS

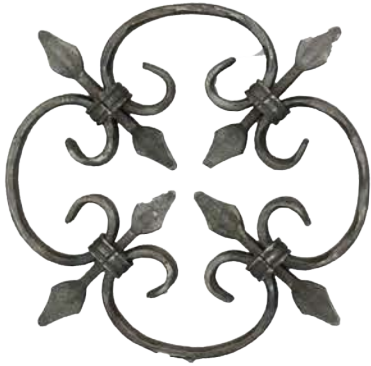

IND-15-1C

Mtl: 9/32" x 5/8"
 Size: 10-3/8" Dia.
 Weight: 21 lbs.
 Packed: 10 pcs/box

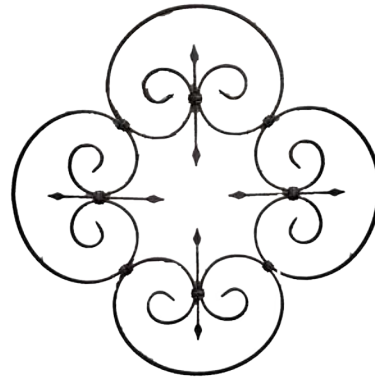

IND-24-3C

Hammered Edge
 Mtl: 3/8" x 1/4"
 Size: 23-5/8" Dia.
 Weight: 13 lbs./box
 Packed 5 pcs/box

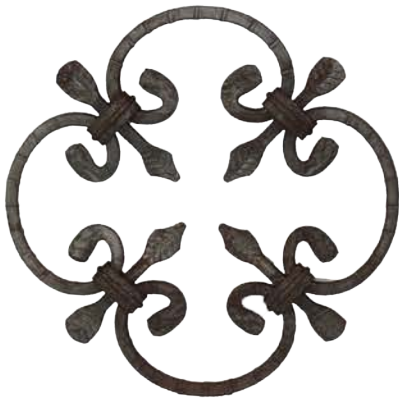

IND-17-1C

Mtl: 5/16" Sq.
 Size: 10" Dia.
 Weight: 20 lbs.
 Packed: 10 pcs/box



IND-26-C-1C

Mtl: 1/2" Sq.
 H: 19-1/2"
 W: 15-1/2"
 Weight: 10 lbs.
 Packed Each



IND-17-2C

Mtl: 5/16" Sq.
 Size: 10" Dia.
 Weight: 10 lbs.
 Packed 20 pcs/box



IND-1013-1C

Mtl: 1/2" Dia. Bar
 H: 11-1/2" Dia.
 Weight: 6 lbs.
 Packed Each

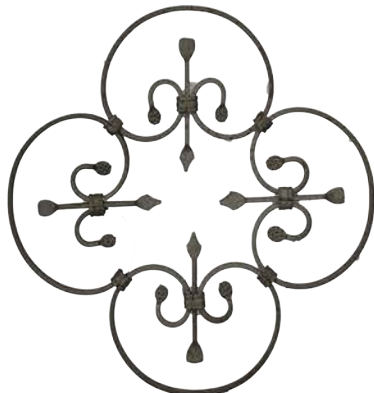

IND-24-2C

Mtl: 3/8" x 1/4"
 Size: 15" Dia.
 Weight: 16 lbs./box
 Packed 5 pcs/box



IND-1013-2C

Mtl: 1/2" Sq.
 Size: 11-1/2" Dia.
 Weight: 7 lbs.
 Packed Each

DECORATIVE PANELS

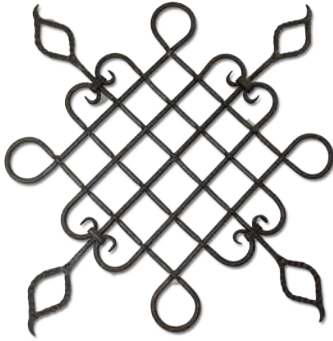

IND-13026

Mtl: 9/16" Dia. Round
H: 32"
W: 32"
Weight: 12 lbs.
Packed Each



IND-13049

Grooved Edge
Mtl: 5/16" x 5/8" Flat bar
H: 28-1/8"
W: 25"
Weight: 21 lbs.
Packed each

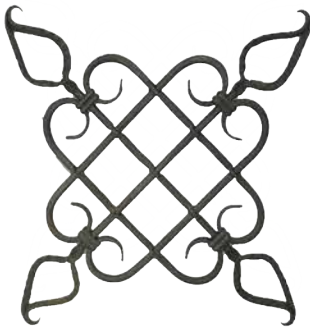

IND-13027

Mtl: 9/16" Dia. Round
H: 16-7/8"
W: 16-7/8"
Weight: 7 lbs.
Packed each



IND-13054

Mtl: 5/16" x 5/8" Flat bar
H: 18-3/4"
W: 18-3/4"
Weight: 8 lbs.
Packed: 20 pcs/box
Packed Each

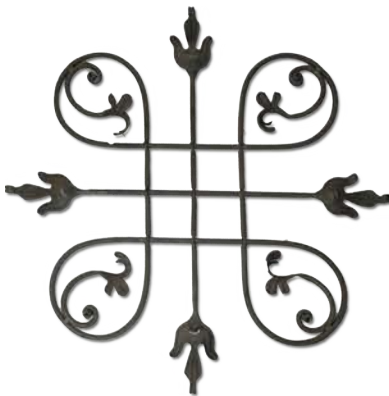

IND-13028

Mtl: 9/16" Dia. Round
H: 30-5/8"
W: 30-5/8"
Weight: 13 lbs.
Packed each



IND-13124

Grooved Edge
Mtl: 5/16" x 5/8" Flat bar
H: 34-3/4"
W: 12-1/4"
Weight: 12 lbs.
Packed each



IND-13029

Grooved Edge
Mtl: 5/16" x 5/8" Bar
H: 28-3/8"
W: 28-3/8"
Weight: 12.35 lbs.
Packed Each



IND-13125

Grooved Edge
Mtl: 5/16" x 5/8" Flat bar
H: 34-3/4"
W: 12-1/4"
Weight: 12 lbs.
Packed each

DECORATIVE PANELS



IND-21025

Size: 24" x 30-3/8"
Weight: 20 lbs.
Packed: Each



IND-51011

H: 16"
W: 16-1/2"
Weight: 10 lbs.
Packed: Each



IND-21027

Size: 14" x 19-1/4"
Weight: 8 lbs.
Packed: Each



IND-51012

H: 39-1/2"
W: 19"
Weight: 28 lbs.
Packed: Each



IND-51006

H: 8"
W: 5-1/8"
Size: 10" Dia.
Weight: 3 lbs./bundle
Packed 5 pcs/bundle



IND-51020

H: 15-3/4"
W: 15"
Weight: 9 lbs.
Packed: Each



IND-51007

H: 11-3/4"
W: 7"
Size: 10" Dia.
Weight: 3 lbs./bundle
Packed 5 pcs/bundle



IND-51021

H: 15-3/4"
W: 16"
Weight: 10 lbs.
Packed: Each

DECORATIVE PANELS



IND-51030

H: 17-1/4"
W: 19"
Weight: 6.4 lbs.
Packed: Each



IND-51201

H: 13-1/2"
W: 42"
Weight: 10 lbs.
Packed: Each



IND-51202

H: 14-1/4"
W: 39-3/4"
Weight: 10 lbs.
Packed: Each



IND-51207

H: 11-1/4"
W: 23-5/8"
Weight: 10 lbs.
Packed: Each



IND-51208

H: 11-1/4"
W: 23-5/8"
Weight: 10 lbs.
Packed: Each

DECORATIVE PANELS



IND-51209

Grooved Edge
Mtl: 5/16" x 5/8"
H: 11-1/2"
W: 35-1/2"
Weight: 8 lbs.
Packed: Each



IND-51214

Mtl: 1/4" x 3/4"
H: 9-1/4"
W: 29-1/2"
Weight: 8 lbs.
Packed: Each



IND-51216

Mtl: 1/4" x 3/4"
H: 12-3/4"
W: 43-5/8"
Weight: 21 lbs.
Packed: Each



IND-678-1C

Mtl: 1/2" Dia. Hammered
H: 3-1/8"
W: 23"
Weight: 3 lbs.
Packed: 10pcs/bundle



IND-678-2C

Grooved Edge
Mtl: 5/16" x 5/8"
H: 3-1/8"
W: 23"
Weight: 3 lbs.
Packed: 10pcs/bundle

DECORATIVE PANELS



IND-13118

Hammered
Mtl: 1/2" Square
H: 31-7/8"
W: 12-1/4"
Weight: 12 lbs.
Packed: 5pcs/bundle



IND-62-1C

Mtl: 3/4" x 1/4"
H: 28-3/8"
W: 9-1/4"
Weight: 10 lbs.
Packed: 5 pcs/bundle



IND-13120

Mtl: 1/2" x 1/4"
H: 34-1/4"
W: 13-1/2"
Weight: 11 lbs.
Packed: 5 pcs/bundle



IND-13065

Matches IND-12065
Mtl: 1/4" x 1/2"
H: 16"
W: 6"
Weight: 5 lbs.
Packed: 5 pcs/bundle



IND-13113

Mtl: 5/16" x 3/4"
H: 34-3/4"
W: 13-3/4"
Weight: 12 lbs.
Packed: 5 pcs/bundle



IND-13114

Mtl: 5/16" x 3/4"
H: 34-3/4"
W: 13-3/4"
Weight: 10 lbs.
Packed: 5 pcs/bundle

FORGED LEAVES



IND-21011

Crown
 H: 7-1/2"
 W: 4-1/4"
 Weight: 3 lbs.
 Packed: 25 pcs/box
 5 pcs/pack



IND-30014

Leaf
 H: 3-1/2"
 W: 1-1/2"
 Weight: 0.10 lbs.
 Packed: 250 pcs/box
 10 pcs/pack

Decorative steel leaves and flowers are great for finishing touches. Choose from our hand selected steel leaves that come in all shapes and sizes to match the decor of the surrounding area.



IND-30021

Leaf
 H: 4-7/8"
 W: 2"
 Weight: 0.10 lbs.
 Packed: 130 pcs/box
 10 pcs/pack



IND-30022

Leaf
 H: 3-7/8"
 W: 2-1/8"
 Weight: 0.25 lbs.
 Packed: 130 pcs/box
 10 pcs/pack



IND-30013

Leaf
 H: 3-1/2"
 W: 1-1/2"
 Weight: 0.10 lbs.
 Packed: 250 pcs/box
 10 pcs/pack



IND-30024

Leaf
 H: 3-3/4"
 W: 3"
 Weight: 0.4 lbs.
 Packed: 200 pcs/box
 10 pcs/pack

FORGED LEAVES



IND-30026

Leaf
H: 4-3/4"
W: 2-3/8"
Weight: 0.25 lbs.
Packed: 100 pcs/box
10 pcs/pack



IND-30031

Flower
H: 5-1/2"
W: 3-1/8"
Weight: 0.70 lbs.
Packed: 50 pcs/box
10 pcs/pack



IND-30028

Leaf
H: 5-5/8"
W: 3-1/2"
Weight: 0.44 lbs.
Packed: 100 pcs/box
10 pcs/pack



IND-30033

Leaf
H: 11"
W: 3-1/2"
Weight: 0.60 lbs.
Packed: 50 pcs/box



IND-30029

Flower
H: 4-3/4"
Weight: 1 lbs.
Packed: 30 pcs/box
10 pcs/pack



IND-30034

Leaf
H: 11"
W: 3-1/2"
Weight: 0.60 lbs.
Packed: 50 pcs/box



IND-30030

Flower
Size: 3-1/4" Dia. Flower
H: 12-1/4"
Weight: 0.60 lbs.
Packed: 50 pcs/box
10 pcs/pack



IND-30035

Leaf
H: 6"
W: 5-7/8"
Weight: 0.80 lbs.
Packed: 40 pcs/box

FORGED LEAVES



IND-30036

Leaf
H: 6"
W: 5-7/8"
Weight: 0.80 lbs.
Packed: 40 pcs/box
10 pcs/pack



IND-30039

Leaf
H: 12"
W: 6"
Weight: 1.40 lbs.
Packed: 30 pcs/box
10 pcs/pack



IND-30037

Leaf
H: 4-3/4"
W: 6"
Weight: 0.60 lbs.
Packed: 40 pcs/box
10 pcs/pack



IND-30040

Leaf
H: 12"
W: 6"
Weight: 1.40 lbs.
Packed: 30 pcs/box
10 pcs/pack



IND-30038

Leaf
H: 4-3/4"
W: 6"
Weight: 0.60 lbs.
Packed: 40 pcs/box
10 pcs/pack

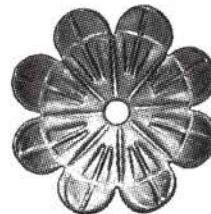

IND-32179

Size: 2" Dia. 1/4" Hole
Mtl: 10 Guage steel
Hole: 1/4"
Weight: 0.10 lbs.
Packed: 100 pcs/box

FORGED GRAPES



“Grapes are one of the earliest cultivated crops known to modern society and have come to symbolize abundance, fertility, and prosperity.”



IND-33016

Grapes
H: 4-1/8”
W: 2-3/4”
Weight: 1 lbs.
Packed: 5 pcs/box



IND-33018

Grapes W/ Cast Steel Leaf
H: 7-1/8”
W: 5-7/8”
Grape Cluster: 5” x 3”
Weight: 3 lbs.
Packed: 5 pcs/box



IND-33017

Grapes
H: 7-1/8”
W: 5-7/8”
Grape Cluster: 4” x 3”
Weight: 2 lbs.
Packed: 5 pcs/box



IND-33019

Grapes W/ Forged Leaf
H: 6-5/8”
W: 5-1/2”
Weight: 3 lbs.
Packed: 5 pcs/box

CAST STEEL ELEMENTS



IND-120-1C

Base Dia.: 1-9/16"
H: 9-3/4"
W: 3-1/4"
Weight: 42 lbs.
Packed: 30 pcs/box



IND-125-1C

Base Dia.: 1-3/8"
H: 5"
W: 2-1/4"
Weight: 18 lbs.
Packed: 30 pcs/box



IND-120-2C

Base Dia.: 1-3/8"
H: 8"
W: 2-3/8"
Weight: 33 lbs.
Packed: 30 pcs/box



IND-122-A-1C

Base Dia.: 1-3/8"
H: 7-7/8"
W: 3"
Weight: 30 lbs.
Packed: 30 pcs/box

CAST STEEL FLORAL ELEMENTS



IND-140-H-3C

Leaf
H: 5"
W: 3-1/2"
Weight: 0.25 lbs.
Packed: 100 pcs/box
10 pcs/pack



IND-661-3C

Leaf
H: 5-7/8"
W: 4-1/2"
Weight: 0.7 lbs.
Packed: 40 pcs/box



IND-661-1C

Leaf
H: 5-7/8"
W: 5"
Weight: 0.6 lbs.
Packed: 40 pcs/box



IND-31040

Leaf
H: 7-3/4"
W: 2-1/2"
Weight: 0.65 lbs.
Packed: 60 pcs/box



IND-661-2C

Leaf
H: 6-1/8"
W: 5-1/2"
Weight: 0.6 lbs.
Packed: 40 pcs/box



IND-663-1C

Leaf
H: 5-1/2"
W: 4-1/4"
Weight: 1 lbs.
Packed: 100 pcs/box



IND-661-4C

Leaf
H: 5"
W: 3"
Weight: 0.3 lbs.
Packed: 50 pcs/box



IND-663-2C

Leaf
H: 5-1/2"
W: 4-1/4"
Weight: 1 lbs.
Packed: 100 pcs/box

CAST STEEL FLORAL ELEMENTS



IND-663-3C

Leaf
H: 3"
W: 3-1/2"
Weight: 12 lbs.
Packed: 40 pcs/box



IND-663-7C

Leaf
H: 3"
W: 3-1/2"
Weight: 12 lbs.
Packed: 40 pcs/box



IND-663-4C

Leaf
H: 3"
W: 3-1/2"
Weight: 12 lbs.
Packed: 40 pcs/box



IND-663-8C

Leaf
H: 3"
W: 3-1/2"
Weight: 12 lbs.
Packed: 40 pcs/box



IND-663-5C

Leaf
H: 5"
W: 5-1/2"
Weight: 16 lbs.
Packed: 40 pcs/box



IND-4140-L

Leaf
H: 5"
W: 5-1/2"
Weight: 16 lbs.
Packed: 40 pcs/box



IND-663-6C

Leaf
H: 5"
W: 5-1/2"
Weight: 16 lbs.
Packed: 40 pcs/box



IND-4140-R

Leaf
H: 5"
W: 5-1/2"
Weight: 16 lbs.
Packed: 40 pcs/box

STAMPED FLORAL ELEMENTS



IND-116-A-3C

Mtl: 1/8"
Dia.: 3-3/4"
Hole: 5/8"
W: 3-1/2"
Weight: 0.4 lbs.
Packed: 100 pcs/box
10 pcs/pack



IND-136-2C

Mtl: 1/8"
H: 4-5/16"
W: 1-1/2"
Weight: 0.2 lbs.
Packed: 200 pcs/box
10 pcs/pack



IND-116-A-4C

Mtl: 1/8"
Dia.: 2-1/4"
Hole: 5/8"
Weight: 0.20 lbs.
Packed: 100 pcs/box
10 pcs/pack



IND-136-3C

Mtl: 1/8"
H: 2-1/2"
W: 2-3/4"
Weight: 0.2 lbs.
Packed: 200 pcs/box
10 pcs/pack



IND-116-A-5C

Mtl: 1/8"
Dia.: 3-3/4"
Weight: 0.6 lbs.
Packed: 100 pcs/box
10 pcs/pack



IND-136-4C

Mtl: 1/8"
H: 2-1/2"
W: 2-3/4"
Weight: 0.2 lbs.
Packed: 200 pcs/box
10 pcs/pack



IND-136-1C

Mtl: 1/8"
H: 4-5/16"
W: 1-1/2"
Weight: 0.2 lbs.
Packed: 200 pcs/box
10 pcs/pack



116-A-4C depicted.

STAMPED FLORAL ELEMENTS



IND-136-10C

Mtl: 1/8"
H: 6-1/4"
W: 2-1/8"
Weight: 0.6 lbs.
Packed: 200 pcs/box
10 pcs/pack



IND-136-17C

Mtl: 5/16"
H: 8-7/8"
W: 1"
Weight: 0.28 lbs.
Packed: 100 pcs/box



IND-136-11C

Mtl: 1/8"
H: 6-1/4"
W: 2-1/8"
Weight: 0.6 lbs.
Packed: 200 pcs/box
10 pcs/pack



IND-136-18C

Mtl: 5/64"
H: 11-1/4"
W: 1-5/8"
Weight: 0.30 lbs.
Packed: 100 pcs/box



IND-136-15C

Mtl: 1/8"
H: 4-3/4"
W: 2-3/4"
Weight: 0.2 lbs.
Packed: 250 pcs/box
10 pcs/pack



IND-136-16C

Mtl: 1/8"
H: 4-3/4"
W: 2-3/4"
Weight: 0.2 lbs.
Packed: 250 pcs/box
10 pcs/pack



13125 & 116-A-5C depicted.

PRESSED SHEET METAL ELEMENTS



IND-136-5C

Mtl: .02"
Dia.: 2-9/16"
H: 1-1/4"
Weight: 0.05 lbs.
Packed: 200 pcs/box
10 pcs/box



IND-137-7C

Mtl: .02"
H: 5"
W: 2-3/8"
Weight: 0.05 lbs.
Packed: 400 pcs/box
20 pcs/box



IND-136-6C

Mtl: .02"
Dia.: 2-1/8"
H: 1-5/8"
Weight: 0.05 lbs.
Packed: 200 pcs/box
10 pcs/box



IND-137-8C

Mtl: .02"
H: 3-1/2"
W: 2"
Weight: 0.05 lbs.
Packed: 400 pcs/box
20 pcs/box



IND-136-7C

Mtl: .02"
Dia.: 1-1/2"
H: 1-1/2"
Weight: 0.05 lbs.
Packed: 200 pcs/box
10 pcs/box



IND-136-8C

Mtl: .02"
Dia.: 1-5/8"
H: 3/4"
Weight: 0.05 lbs.
Packed: 250 pcs/box
10 pcs/box

"The difference between something good and something great is attention to detail. Floral elements instantly add intricate elegance to any design."

PRESSED SHEET METAL ELEMENTS



IND-137-9C

Mtl: .02"
H: 2-1/2"
W: 4-1/4"
Weight: 0.05 lbs.
Packed: 400 pcs/box
20 pcs/pack



IND-138-11C

Mtl: .02"
H: 2-3/4"
W: 3"
Weight: 0.03 lbs.
Packed: 300 pcs/box
20 pcs/pack



IND-137-10C

Mtl: .02"
H: 5"
W: 6-7/8"
Weight: 0.01 lbs.
Packed: 200 pcs/box
20 pcs/pack



IND-138-12C

Mtl: .02"
H: 4-1/8"
W: 3-3/4"
Weight: 0.06 lbs.
Packed: 200 pcs/box
20 pcs/pack



IND-138-3C

Mtl: 1/8"
H: 1/2"
W: 3-1/8"
Weight: 0.15 lbs.
Packed: 250 pcs/box
10 pcs/pack



IND-138-13C

Mtl: .02"
H: 7-5/8"
W: 7-1/2"
Weight: 0.07 lbs.
Packed: 200 pcs/box
20 pcs/pack



IND-138-4C

Mtl: 5/64"
H: 3/8"
W: 3-1/2"
Weight: 0.01 lbs.
Packed: 200 pcs/box
10 pcs/pack



IND-139-1C

Mtl: .02"
H: 2-1/2"
W: 1-1/8"
Weight: 0.01 lbs.
Packed: 400 pcs/box
20 pcs/pack



IND-138-10C

Mtl: .0197"
H: 3-3/8"
W: 1-3/4"
Weight: 0.02 lbs.
Packed: 250 pcs/box
10 pcs/pack

PRESSED SHEET METAL ELEMENTS



IND-139-3C

Mtl: .02"
H: 3-1/2"
W: 1-1/4"
Weight: 0.04 lbs.
Packed: 200 pcs/box
10 pcs/pack



IND-604-11C

Mtl: 1/16"
H: 1-7/8"
W: 1-3/8"
Weight: 0.01 lbs.
Packed: 200 pcs/box
20 pcs/pack
Match for 604/6C &
604/7C



IND-139-4C

Mtl: .02"
H: 7-7/8"
W: 2-1/2"
Weight: 0.07 lbs.
Packed: 200 pcs/box
20 pcs/pack



IND-604-12C

Mtl: 1/16"
H: 2"
W: 1-3/8"
Weight: 0.01 lbs.
Packed: 200 pcs/box
20 pcs/pack
Match for 604/6C and
604/7C



IND-139-5C

Mtl: .02"
H: 4-1/8"
W: 1-1/2"
Weight: 0.04 lbs.
Packed: 500 pcs/box
20 pcs/pack



IND-140-1C

Mtl: .02"
H: 2-1/8"
W: 3/4"
Weight: 0.15 lbs.
Packed: 250 pcs/box
10 pcs/pack



IND-139-6C

Mtl: 5/64"
H: 2-3/4"
W: 1-1/8"
Weight: 0.03 lbs.
Packed: 400 pcs/box
20 pcs/pack



IND-140-2C

Mtl: .02"
H: 2-1/2"
W: 1-5/32"
Weight: 0.08 lbs.
Packed: 500 pcs/box
20 pcs/pack

PRESSED SHEET METAL ELEMENTS



IND-140-3C

Mtl: .02"
H: 3-1/8"
W: 1-1/2"
Weight: 0.06 lbs.
Packed: 300 pcs/box
20 pcs/pack



IND-140-8C

Mtl: .02"
H: 3/8"
Dia.: 1-1/2"
Weight: 0.01 lbs.
Packed: 200 pcs/box
20 pcs/pack



IND-140-5C

Mtl: .02"
H: 2-3/4"
W: 2-3/4"
Weight: 0.01 lbs.
Packed: 200 pcs/box
10 pcs/pack



IND-SS1101

Mtl: .02"
H: 7-1/4"
W: 2-1/4"
Weight: 0.01 lbs.
Packed: 200 pcs/box
20 pcs/pack



IND-140-6C

Mtl: .02"
H: 5/8"
Dia.: 3/4"
Weight: 0.01 lbs.
Packed: 200 pcs/box
10 pcs/pack



IND-SS1102

Mtl: .02"
H: 9"
W: 2-5/8"
Weight: 0.01 lbs.
Packed: 200 pcs/box
20 pcs/pack



IND-140-7C

Mtl: .02"
H: 1/2"
Dia.: 1"
Weight: 0.01 lbs.
Packed: 200 pcs/box
20 pcs/pack



IND-SS1103

Mtl: .02"
H: 11-1/2"
W: 2-1/8"
Weight: 0.01 lbs.
Packed: 200 pcs/box
20 pcs/pack

SPHERE AND BASKET

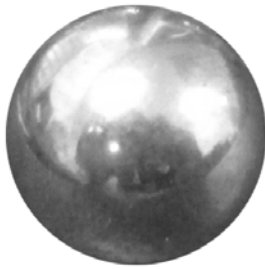

STAMPED SPHERE

Item#	Dia.	Wgt	Pk
IND-116F-1C	3/4"	60 lbs.	500/bx
IND-116F-2C	1"	30 lbs.	200/bx
IND-116F-3C	1-3/16"	30 lbs.	100/bx
IND-116F-4C	1-9/16"	45 lbs.	75/bx
IND-116F-5C	2"	65 lbs.	50/bx



FORGED SPHERE

Item#	Dia.	Wgt	Pk
IND-117-2C	3/4"	50 lbs.	500/bx
IND-117-4C	1-1/4"	30 lbs.	100/bx
IND-117-5C	1-1/2"	25 lbs.	50/bx



BASKET

Item#	H	W	End	Wgt	Pk
IND-159-1C	3-9/16"	1-3/8"	5/16"	10 lbs.	100/bx
IND-159-3C	5"	2-3/8"	1/2"	35 lbs.	70/bx
IND-159-4C	5"	2-1/2"	9/16"	42 lbs.	60/bx
IND-159-5C	5-3/4"	2-9/16"	5/8"	36 lbs.	40/bx
IND-159-6C	6-1/2"	3-1/8"	3/4"	37.5 lbs.	25/bx
IND-159-7C	7"	3-3/4"	15/16"	54 lbs.	20/bx
IND-158B-7C	ROUND	2-3/4" dia.	1/4"	50 lbs.	100/bx

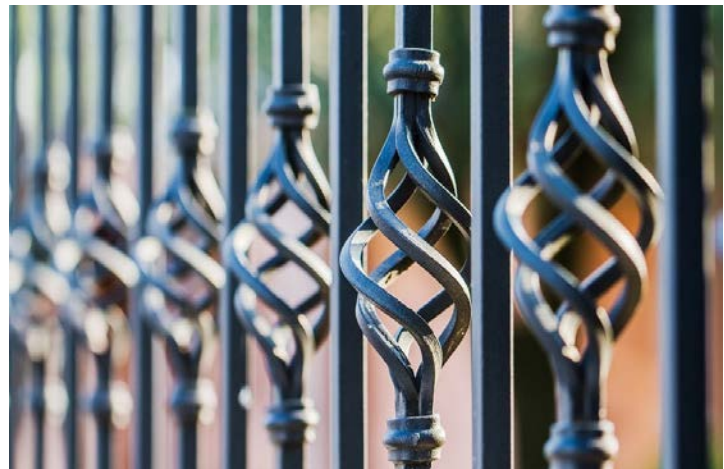

159/3C depicted

DECORATIVE ROUND BAR

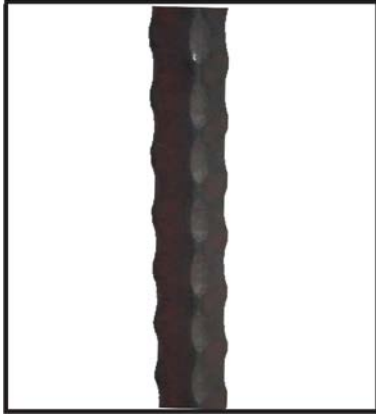

SQUARE HAMMERED BAR

Item#	Dia.	L	Wgt	Pk
IND-FT12A	1/2"	10 ft.	75 lbs.	10/bdl
IND-FT16A	5/8"	10 ft.	135 lbs.	10/bdl
IND-FT18A	3/4"	10 ft.	175 lbs.	5/bdl



HAMMERED ROUND BAR

Item#	Dia.	L	Wgt	Pk
IND-YT12A	1/2"	10 ft.	60 lbs.	10/bdl
IND-YT16A	5/8"	10 ft.	100 lbs.	10/bdl
IND-YT18A	3/4"	10 ft.	67.5 lbs.	5/bdl



VINEYARD BAR

Item#	Dia.	L	Wgt	Pk
IND-598-11	5/16"	10 ft.	25 lbs.	10/bdl
IND-598-13	1/2"	10 ft.	58 lbs.	10/bdl
IND-598-16	3/4"	10 ft.	64 lbs.	5/bdl



TREE BARK BAR

Item#	Dia.	L	Wgt	Pk
IND-599-1	5/16"	10 ft.	25 lbs.	10/bdl
IND-599-2	3/8"	10 ft.	40 lbs.	10/bdl
IND-599-3	1/2"	10 ft.	70 lbs.	10/bdl
IND-599-5	5/8"	10 ft.	55 lbs.	5/bdl

END PIECES FOR HANDRAILS



IND-126-2C

H: 11"
W: 15"
Weight: 3 lbs.
For Handrail 114-8C



IND-126-3C

H: 11"
W: 15"
Weight: 3 lbs.
For Handrail 114-9C



IND-126-4C

H: 11"
W: 15"
Weight: 3 lbs.
For Handrail BT840D



IND-126-5C

H: 11"
W: 15"
Weight: 3 lbs.
For Handrail BT850E



IND-126-6C

H: 11"
W: 15"
Weight: 3 lbs.
For Handrail BT1850VF



IND-126-14C

H: 5"
W: 12"
Weight: 3 lbs.
For Handrail BT840D



IND-126-15C

H: 5"
W: 12"
Weight: 3 lbs.
For Handrail BT850E



IND-126-16C

H: 5"
W: 12"
Weight: 3 lbs.
For Handrail BT1850VF

INDEX

AL-03023	63	AL-121D	67	AL-204BNBSH	65	AL-251-34D	67	AL-4R	68
AL-03038-12	53	AL-122	58	AL-21-12	57	AL-251-58D	67	AL-4RNT	68
AL-03038-58	53	AL-124	57	AL-21-34	57	AL-252-12	54	AL-5-12	54
AL-03038SH-12	53	AL-130	58	AL-215-12D	67	AL-252-34	54	AL-552	59
AL-03039-12	53	AL-13-12	52	AL-215-34D	67	AL-252-58	54	AL-560	58
AL-03039-58	53	AL-134	62	AL-21-58	57	AL-258	56	AL-564	58
AL-03039SH-12	53	AL-135	62	AL-216	63	AL-26-12	54	AL-5R	68
AL-03068	53	AL-138	62	AL-217B-12D	67	AL-26SH-12	54	AL-5RNT	68
AL-03068SH	53	AL-142	62	AL-217B-34D	67	AL-270	59	AL-61	61
AL-03068SHWT	53	AL-142D	68	AL-217B-58D	67	AL-27-12	54	AL-62	61
AL-03700	63	AL-143D	68	AL-21SF-12	52	AL-275-12	54	AL-63	61
AL-1000L	59	AL-144D	68	AL-21SFSH-12	52	AL-275-34	54	AL-709F	63
AL-1000R	59	AL-145D	68	AL-21SFSHNT-12	52	AL-275-58	54	AL-717	61
AL-101	55	AL-146	62	AL-21SFSHNT-12B	52	AL-2T-12	52	AL-718	61
AL-102	55	AL-147D	68	AL-21SFSHNT-12W	52	AL-2T-34	52	AL-719	60
AL-103-12	55	AL-148	57	AL-23-12	58	AL-2T-34NT	52	AL-762L	59
AL-103-58	55	AL-151	57	AL-23-34	58	AL-2T-58	52	AL-762R	59
AL-105	55	AL-154	57	AL-23-58	58	AL-2TSH-12	52	AL-8-12	52
AL-106	55	AL-156	56	AL-23SH-12	58	AL-2TSH-12B	52	AL-8-12NT	52
AL-107-12	55	AL-158	57	AL-23SH-34	58	AL-2TSH-12W	52	AL-8-34	52
AL-107-34	55	AL-176	63	AL-23SH-58	58	AL-3702	60	AL-8-34NT	52
AL-107-58	55	AL-181	56	AL-238	63	AL-3703	60	AL-8-34SH	52
AL-109	56	AL-182	56	AL-23SH-12	52	AL-3705	60	AL-8-58	52
AL-110	55	AL-183	56	AL-244-12	53	AL-3706	60	AL-8SH-12	52
AL-113	55	AL-187-12	53	AL-244-34	53	AL-3711	60	AL-8SH-12B	52
AL-115B	56	AL-187-34	53	AL-244-58	53	AL-3712	60	AL-8SH-12W	52
AL-117	63	AL-187-58	53	AL-245-12	53	AL-3T-12	52	AL-9Z	67
AL-118D	67	AL-190S	56	AL-245-34	53	AL-3T-34	52	AL-B100	68
AL-119	58	AL-192-12	53	AL-245-58	53	AL-3T-58	52	AL-B112	68
AL-119D	67	AL-192-34	53	AL-245SH-12	53	AL-3TSH-12	52	AL-B200	68
AL-120	58	AL-192-58	53	AL-247	59	AL-3TSH-12B	52	AL-B212	68
AL-120D	67	AL-196-12	53	AL-251-12D	67	AL-3TSH-12W	52	AL-B300	68
AL-12-12	52	AL-204BNB	65	AL-251-1D	67	AL-442L	65	AL-B34	68



THIS PAGE INTENTIONALLY LEFT BLANK



THIS PAGE INTENTIONALLY LEFT BLANK

INDEX

AL-BH3A	66	AL-SHMM	67	CL-681DF	43	CL-8527-58	40	CL-A3	47
AL-BH93R	66	AL-SHRR	67	CL-6LT	44	CL-853-12	36	CL-A to Z	50
AL-CE1-12	54	CL-100	50	CL-7009	35	CL-853-34	36	CL-BH3A	45
AL-M1	64	CL-145	47	CL-7056	44	CL-853-58	36	CL-BH3B	45
AL-M11	65	CL-22	48	CL-731-1	36	CL-853H-58	36	CL-BH3HRB	45
AL-M11SH	63	CL-23A	48	CL-731-12	36	CL-853Y-34	36	CL-HK8127	42
AL-M12	65	CL-32	48	CL-731-34	36	CL-8587	40	CL-HK8347	42
AL-M13	65	CL-34	48	CL-731-58	36	CL-88-12SM	36	CL-HK8587	42
AL-M13SH	65	CL-35	48	CL-74X	48	CL-8832	35	CL-N0 to N9	50
AL-M14	65	CL-431	35	CL-80C	49	CL-8832H	35	CL-SHBB	41
AL-M15H	64	CL-431H	35	CL-81	49	CL-8832Y	35	CL-SHDD	41
AL-M2	64	CL-431Y	35	CL-8117	40	CL-88-34	36	CL-SHKK2	41
AL-M2S	64	CL-440	47	CL-8127	40	CL-88-34SM	36	CL-SHRR	41
AL-M2SH	64	CL-5A	44	CL-82	49	CL-88-58	36	DUC-6154	70
AL-M3	64	CL-5LT	44	CL-825	35	CL-89BXL	47	DUC-6505	70
AL-M3SH	64	CL-612-12	40	CL-826	35	CL-8X	37	DUC-6528D	71
AL-M4	64	CL-612-58	40	CL-831	35	CL-900	44	DUC-6528S	71
AL-M4SH	64	CL-65	48	CL-831H	35	CL-901	44	DUC-6529D	70
AL-M5	64	CL-651-12	35	CL-831Y	35	CL-902	44	DUC-6529S	70
AL-M5SH	64	CL-660-12	40	CL-8333	49	CL-9050	43	DUC-6531S	70
AL-M6	64	CL-660-34	40	CL-8347	40	CL-9050DF	43	DUC-6532S	70
AL-M6SH	64	CL-660-58	40	CL-85	49	CL-9052	43	DUC-6533	70
AL-M7	64	CL-661	38	CL-8518-12	40	CL-9052DF	43	DUC-6535	70
AL-M7SH	64	CL-662	37	CL-8518-58	40	CL-9053	43	DUC-9508	71
AL-M8	64	CL-668-12	34	CL-8521-12	40	CL-9054	43	DUC-9579	71
AL-M8SH	64	CL-668-34	34	CL-8521-34	40	CL-9054DF	43	DUC-9960	71
AL-MS13	65	CL-668-58	34	CL-8521-58	40	CL-9503	42	DUC-9961	71
AL-MS14	65	CL-670	35	CL-8526	40	CL-950358	42	DUC-B1	69
AL-SH1	68	CL-670CF	38	CL-8526H	40	CL-9536	39	DUC-B112	69
AL-SH112	68	CL-670H	35	CL-8526Y	40	CL-9537	39	DUC-B2	69
AL-SH114	68	CL-670Y	35	CL-8526Z	40	CL-9538	39	DUC-B3	69
AL-SH2	68	CL-679XL	48	CL-8527-12	40	CL-9XS-12	35	DUC-B34	69
AL-SHLL	67	CL-681	43	CL-8527-34	40	CL-A2	49	DUC-B4	69

INDEX

DUC-BH2305	69	DUC-SH398	72	HD-10LSFORB	30	HD-BS212	18	HD-CS312	18
DUC-BH2306	69	DUC-SHEE	72	HD-10LSFPB	30	HD-BS3	18	HD-CS34	18
DUC-BH2381	69	DUC-SHGG	72	HD-10LSFSC	30	HD-BS4	18	HD-CS4	18
DUC-BH2382	69	DUC-SHMM	72	HD-13MSCSAB	30	HD-BS5	18	HD-CS5	18
DUC-RE100CC	73	DUC-SHR2	72	HD-13MSCSOR	30	HD-BS6	18	HD-CS6	18
DUC-RE125CC	73	DUC-SHR3	72	HD-13MSCSPB	30	HD-BS8	18	HD-CS8	18
DUC-RE4429B	73	DUC-SHR5	72	HD-13MSCSSC	30	HD-BSH112	18	HD-DC1107	30
DUC-RE4429C	73	DUC-SHR60	72	HD-13MSFAB	30	HD-BSH12	18	HD-DC1107W	30
DUC-RE4429E	73	DUC-SHR61	72	HD-13MSFOR	30	HD-BSH2	18	HD-DC1108	30
DUC-RE4429L	74	DUC-TB136	69	HD-13MSFPB	30	HD-BSH212	18	HD-DC1108W	30
DUC-RE4429N	73	DUC-TB196	69	HD-13MSFSC	30	HD-BSH3	18	HD-DC1601	30
DUC-RE4429S	73	FIT-E4512	19	HD-ANI11	11	HD-BSH4	18	HD-DC1601B	30
DUC-RE4429T	74	FIT-E4514	19	HD-ANI1112	11	HD-BSH5	18	HD-DS12	5
DUC-RE4429V	74	FIT-E4520	19	HD-ANI1114	11	HD-BSH6	18	HD-DS9	5
DUC-RE4441C	73	FIT-E4530	19	HD-ANI12	11	HD-BSH8	18	HD-FRH112	19
DUC-RE4441E	73	FIT-E4540	19	HD-BC1212	5	HD-BVG3	5	HD-FRH112NH	19
DUC-RE4441N	73	FIT-E9010	19	HD-BC1812	5	HD-BVG4	5	HD-FRH114	19
DUC-RE4441S	73	FIT-E9012	19	HD-BC2458	5	HD-BVG6	5	HD-FRH114NH	19
DUC-RE4441V	74	FIT-E9014	19	HD-BCBRK	5	HD-BVGSP6	5	HD-FRH200	19
DUC-REC401LM	50	FIT-E9020	19	HD-BCL12	5	HD-BWF12	3	HD-FRH200NH	19
DUC-REC401RM	50	FIT-E9030	19	HD-BGHJ	6	HD-BWF34	3	HD-FSH41	15
DUC-REC421LM	50	FIT-E9040	19	HD-BGHJ34	6	HD-BWF58	3	HD-FSH4112	15
DUC-REC421RM	50	FIT-EC10	19	HD-BGHJ58	6	HD-BWM12	3	HD-FSH4114	15
DUC-REC441LM	50	FIT-EC112	19	HD-BGHJZ	6	HD-BWM34	3	HD-FSH42	15
DUC-REC441RM	50	FIT-EC114	19	HD-BH212	16	HD-BWM58	3	HD-GC2000	31
DUC-REL400L	50	FIT-EC20	19	HD-BH212R	16	HD-BXC20	5	HD-GC3000	31
DUC-REL400R	50	FIT-EC30	19	HD-BH300	16	HD-BXHDS34	6	HD-HB2	1
DUC-REL420L	50	FIT-EC40	19	HD-BH300R	16	HD-CS1	18	HD-HB3	1
DUC-REL420R	50	HD-10LSCSAB	30	HD-BH302	16	HD-CS112	18	HD-HB5ADJ	4
DUC-REL440L	50	HD-10LSCSOR	30	HD-BHDS12	6	HD-CS114	18	HD-HB5C	1
DUC-REL440R	50	HD-10LSCSPB	30	HD-BS112	18	HD-CS2	18	HD-HB5NS	1
DUC-SH362	72	HD-10LSCSSC	30	HD-BS12	18	HD-CS212	18	HD-HB5NSNP	1
DUC-SH363	72	HD-10LSFAB	30	HD-BS2	18	HD-CS3	18	HD-HB5REC	4

INDEX

HD-HB7	1	HD-HT5	1	HD-SA383	10	HD-ST143	10	HD-WR65R	9
HD-HB7ADJ	4	HD-HT7	1	HD-SA516112	10	HD-TADPT	11	HD-WR65S	9
HD-HB7NS	1	HD-HU7	3	HD-SA516212	10	HD-TOTB	32	HD-WR75B	9
HD-HB7NSNP	1	HD-HU9	3	HD-SBWVG4	7	HD-TOWD516	11	HD-WR75R	9
HD-HB7REC	4	HD-LBAR	6	HD-SD112	15	HD-TR10	17	HD-WR75S	9
HD-HB9	1	HD-LFG	6	HD-SD158	15	HD-TR312	17	HD-WGFR11R	32
HD-HB9NP	1	HD-LNHG	6	HD-SD178	15	HD-TR314	17	HD-WGFR7R	32
HD-HBX35	2	HD-LS38L	10	HD-SD335	15	HD-TR4	17	HD-WGFR9R	32
HD-HBX35ADJ	2	HD-LS38S	10	HD-SD36	15	HD-TR412	17	HD-WGFRPBD	32
HD-HBX35T	2	HD-LS516L	10	HD-SHX1	11	HD-TR414	17	HD-WSLG	5
HD-HBX4	2	HD-LS516S	10	HD-SHX115	11	HD-TR5	17	HD-WT101	12
HD-HHB	4	HD-LUGGBXL	6	HD-SHX12	11	HD-TR512	17	HD-WT101XL	12
HD-HHD33	1	HD-LUGGZ	6	HD-SHX13	11	HD-TR514	17	HD-WT102	12
HD-HHD33S	1	HD-MB3	15	HD-SHX32	11	HD-TR6	17	HD-WT102XL	12
HD-HHD44	1	HD-MB4	15	HD-SHX33	11	HD-TR7	17	HD-WT103	12
HD-HHD55	1	HD-MB6	15	HD-SHX34	11	HD-TR8	17	HD-WT104	12
HD-HHD66	1	HD-MB8	15	HD-SHX51	11	HD-TRR312	17	HD-WT104S	12
HD-HHP	4	HD-NR3	5	HD-SHX52	11	HD-TRR4	17	HD-WT104XL	12
HD-HHSP	4	HD-NR6	5	HD-SHX53	11	HD-VDC107	30	HD-WT105	12
HD-HHW	4	HD-NR12	5	HD-SHX54	11	HD-VDC107W	30	HD-WT106	12
HD-HHZ	4	HD-OTC	8	HD-SOWL11	10	HD-WC4B	9	HD-WT107	12
HD-HSD22	1	HD-OTC4	8	HD-SOWL115	10	HD-WC4R	9	HD-WT108	13
HD-HSD3134	1	HD-OTCH	8	HD-SOWL12	10	HD-WC4S	9	HD-WT109	13
HD-HSD33	1	HD-OTCHX	8	HD-SOWL125	10	HD-WC5B	9	HD-WT110	14
HD-HSD35225T	1	HD-OTCHX114	8	HD-SOWL13	10	HD-WC5R	9	HD-WT113	14
HD-HSD3535	1	HD-RR12	5	HD-SOWL515	10	HD-WC5S	9	HD-WT114	14
HD-HSD44	1	HD-RR3	5	HD-SOWL52	10	HD-WC6B	9	HD-WT115	14
HD-HSP312B	4	HD-RR3D	5	HD-SOWL53	10	HD-WC6R	9	HD-WT116	14
HD-HSP312M	4	HD-RR6	5	HD-SOWL54	10	HD-WC6S	9	HD-WT118	14
HD-HSP412M	4	HD-RR6D	5	HD-SOWL55	10	HD-WR50B	9	HD-WT124	14
HD-HSP4B	4	HD-RR12D	5	HD-SOWL56	10	HD-WR50R	9	HD-WT125	14
HD-HSP4M	4	HD-SA123	10	HD-ST14112	10	HD-WR50S	9	HD-WT202	13
HD-HT3	1	HD-SA38178	10	HD-ST142	10	HD-WR65B	9	HD-WT204S	13

INDEX

HD-WT204XL	13	IND-116F-1C	118	IND-12705	81	IND-137-10C	115	IND-155-1C	85
HD-WT209	13	IND-116F-2C	118	IND-12707	84	IND-137-7C	114	IND-155-2C	85
HD-WT210	14	IND-116F-3C	118	IND-12710D	84	IND-137-8C	114	IND-155-3C	85
HD-WT220	14	IND-116F-4C	118	IND-12710S	84	IND-137-9C	115	IND-155-4C	85
HD-WT303B	14	IND-116F-5C	118	IND-12905	81	IND-138-10C	115	IND-155-6C	85
HD-WT304B	14	IND-117-2C	118	IND-12908	82	IND-138-11C	115	IND-158B-7C	118
HD-WT305B	14	IND-117-4C	118	IND-13026	100	IND-138-12C	115	IND-159-1C	118
HD-WT306B	14	IND-117-5C	118	IND-13027	100	IND-138-13C	115	IND-159-3C	118
HD-WT308B	14	IND-12006	81	IND-13028	100	IND-138-3C	115	IND-159-4C	118
HD-WT310B	14	IND-12008	81	IND-13029	100	IND-138-4C	115	IND-159-5C	118
HD-WT5RB	14	IND-120-1C	109	IND-13049	100	IND-139-1C	115	IND-159-6C	118
HD-WT6RB	14	IND-12026	81	IND-13054	100	IND-139-3C	116	IND-159-7C	118
HD-WT7RB	14	IND-12027	80	IND-13065	104	IND-139-4C	116	IND-17-1C	99
HD-WT8RB	14	IND-120-2C	109	IND-13113	104	IND-139-5C	116	IND-17-2C	99
HD-WVG3	7	IND-12040	80	IND-13114	104	IND-139-6C	116	IND-21011	105
HD-WVG4B	7	IND-12041	80	IND-13118	104	IND-14003	86	IND-21025	101
HD-WVG4N	7	IND-12042	80	IND-13120	104	IND-14008	86	IND-21027	101
HD-WVG6	7	IND-12043	80	IND-13124	100	IND-14016	86	IND-24-2C	99
HD-WVGGSP3	7	IND-12065	81	IND-13125	100	IND-140-1C	116	IND-24-3C	99
HD-WVGGSP4	7	IND-12068	82	IND-136-10C	113	IND-140-2C	116	IND-26-C-1C	99
HD-WVGGSP6	7	IND-122A-1C	109	IND-136-11C	113	IND-140-3C	117	IND-30013	105
IND-1013-1	99	IND-125-1C	109	IND-136-15C	113	IND-14048	86	IND-30014	105
IND-1013-2	99	IND-126-14C	120	IND-136-16C	113	IND-14049	86	IND-30021	105
IND-105-1C	82	IND-126-15C	120	IND-136-17C	113	IND-140-5C	117	IND-30022	105
IND-105-1LC	82	IND-126-16C	120	IND-136-18C	113	IND-140-6C	117	IND-30024	105
IND-105-2C	82	IND-126-2C	120	IND-136-1C	112	IND-140-7C	117	IND-30026	106
IND-105-2LC	82	IND-126-3C	120	IND-136-2C	112	IND-140-8C	117	IND-30028	106
IND-108-A-1	82	IND-126-4C	120	IND-136-3C	112	IND-140H-3C	110	IND-30029	106
IND-108-A-2	82	IND-126-5C	120	IND-136-4C	112	IND-148-1C	85	IND-30030	106
IND-109-3C	83	IND-126-6C	120	IND-136-5C	114	IND-148-2C	85	IND-30031	106
IND-116A-3C	112	IND-12703	83	IND-136-6C	114	IND-149-1C	85	IND-30033	106
IND-116A-4C	112	IND-12704	81	IND-136-7C	114	IND-15-1C	99	IND-30034	106
IND-116A-5C	112	IND-12704DB	81	IND-136-8C	114	IND-154-2C	85	IND-30035	106

INDEX

IND-30036	107	IND-50-5C	76	IND-576-4C	83	IND-61135	93	IND-64-L-3C	83
IND-30037	107	IND-50-5LC	76	IND-598-11	119	IND-61136	93	IND-64-L-4C	83
IND-30038	107	IND-50-6C	76	IND-598-13	119	IND-61157	93	IND-64-R-3C	83
IND-30039	107	IND-50-6LC	76	IND-598-16	119	IND-61158	93	IND-64-R-4C	83
IND-30040	107	IND-50-7C	76	IND-599-1	119	IND-62001	94	IND-65-847LC	77
IND-31040	105	IND-50-7LC	76	IND-599-2	119	IND-62002	94	IND-65-8C	77
IND-32179	107	IND-50-8C	76	IND-599-3	119	IND-62003	94	IND-661-1C	110
IND-33016	108	IND-50-8LC	77	IND-599-5	119	IND-62004	94	IND-661-2C	110
IND-33017	108	IND-51006	101	IND-60-3C	78	IND-62005	94	IND-661-3C	110
IND-33018	108	IND-51007	101	IND-604-11C	116	IND-62006	94	IND-661-4C	110
IND-33019	108	IND-51011	101	IND-604-12C	116	IND-62007	94	IND-663-1C	110
IND-35-1C	90	IND-51012	101	IND-604-6C	84	IND-62008	94	IND-663-2C	110
IND-35-2C	90	IND-51020	101	IND-604-7C	84	IND-62-1C	99	IND-663-3C	111
IND-36-1C	90	IND-51021	101	IND-61001	95	IND-63001	17	IND-663-4C	111
IND-36-2C	90	IND-51030	102	IND-61002	95	IND-63006	17	IND-663-5C	111
IND-37-3C	90	IND-51201	102	IND-61003	95	IND-63008	17	IND-663-6C	111
IND-37-4C	90	IND-51202	102	IND-61004	95	IND-63102	17	IND-663-7C	111
IND-4140-L	111	IND-51207	102	IND-61005	95	IND-63104	17	IND-663-8C	111
IND-4140-R	111	IND-51208	102	IND-61006	95	IND-63201	17	IND-678-1C	103
IND-44-12C	87	IND-51209	103	IND-61007	95	IND-64022	94	IND-678-2C	103
IND-47-10C	87	IND-51214	103	IND-61008	95	IND-64-B-2C	78	IND-70-D-1C	80
IND-47-11C	87	IND-51216	103	IND-61034	96	IND-64-F-1	86	IND-70-D-5C	87
IND-47-7C	87	IND-51-3C	77	IND-61035	96	IND-64-F-3C	78	IND-80-A-10C	91
IND-48-1C	75	IND-52-2C	77	IND-61039	96	IND-64-F-3LC	78	IND-80-A-11C	91
IND-48-1LC	75	IND-52-3C	77	IND-61040	96	IND-64-F-5C	78	IND-80-A-12C	91
IND-48-2C	75	IND-52A-4SC	78	IND-61041	96	IND-64-F-5LC	79	IND-80-A-13C	91
IND-48-2LC	75	IND-52A-4SLC	78	IND-61042	96	IND-64-F-9C	79	IND-80-A-15C	91
IND-48-3C	75	IND-53-1C	77	IND-61048	96	IND-64-F-9DC	79	IND-80-A-17C	92
IND-48-3LC	75	IND-53-25C	86	IND-61049	96	IND-64-H-10C	87	IND-80-A-1C	91
IND-48-4C	75	IND-53-347LC	77	IND-61051	96	IND-64-I-2C	79	IND-80-A-22C	92
IND-48-4LC	75	IND-53-3C	77	IND-61052	96	IND-64-I-2LC	79	IND-80-A-23C	92
IND-49-3C	76	IND-541-2C	80	IND-61121	93	IND-64-I-3C	79	IND-80-A-24C	92
IND-50-25C	86	IND-576-2C	83	IND-61122	93	IND-64-I-3LC	79	IND-80-A-30C	92

INDEX

IND-80-A-33C	92	IND-SS1101	117	LCK-DC5	26	LCK-EZT6453	25	LCK-SC3S	26
IND-80-A-3C	91	IND-SS1102	117	LCK-DC5L	26	LCK-EZT64532D	25	LCK-SC5	26
IND-80-A-9C	91	IND-SS1103	117	LCK-EZDTLK-363	24	LCK-KK9301	24	LCK-SC5L	26
IND-84-7C	92	IND-YT12A	119	LCK-EZDTLK-365	24	LCK-LHM3	24	LCK-SLH20026D	23
IND-90-T1	88	IND-YT16A	119	LCK-EZDTLK-3632D	24	LCK-LHM363	24	LCK-SLH2003	23
IND-90-T2	88	IND-YT18A	119	LCK-EZD21110B	25	LCK-LHM365	24	LCK-SLH53610B	23
IND-90-T3	88	LCK-13-105	29	LCK-EZD2113	25	LCK-LHM5	24	LCK-SLH53626D	23
IND-90-T4	88	LCK-13-115	29	LCK-EZD21132D	25	LCK-LSIPBD	26	LCK-SLH5363	23
IND-90-T5	88	LCK-13-134	29	LCK-EZD2115	25	LCK-LSIPBS	26	LCK-SLH55610	23
IND-90-T6	88	LCK-13-205	29	LCK-EZDT10B	25	LCK-MLH111P	21	LCK-SLH55626	23
IND-90-T7	88	LCK-13-215	29	LCK-EZDT3	25	LCK-MLH1126D	21	LCK-SLH5563	23
IND-90-T8	89	LCK-15-125	28	LCK-EZDT32D	25	LCK-MLH113	21	LCK-SLH556SGL10	22
IND-90-T9	89	LCK-15-150R	28	LCK-EZDT5	25	LCK-MLH115	21	LCK-SLH556SGL26D	22
IND-90-T10	89	LCK-15-150S	28	LCK-EZLHK3	24	LCK-MLH233	21	LCK-SLH556SGL3	22
IND-90-T11	89	LCK-15-176	28	LCK-EZLHK32	24	LCK-MLH235	21	LCK-TCY938511P	22
IND-93-4C	93	LCK-15-225	28	LCK-EZLHK363	24	LCK-MLK211P	22	LCK-TCY938526D	22
IND-94-3C	93	LCK-15-225NG	28	LCK-EZLHK365	24	LCK-MLK2226D	22	LCK-TCY93853	22
IND-94-C-11C	98	LCK-15-250R	28	LCK-EZLHK5	24	LCK-MLK223	22	LCK-TCY93855	22
IND-94-C-12C	98	LCK-15-250S	28	LCK-EZS11110B	25	LCK-MLK225	22	LPT-BPH9355	22
IND-94-E-1C	98	LCK-15-276	28	LCK-EZS1113	25	LCK-MLK4026D	21	LPT-CY938011P	22
IND-94-E-2C	98	LCK-15-605L	28	LCK-EZS11132D	25	LCK-MLK403	21	LPT-CY938011PS	22
IND-94-E-3C	98	LCK-15-605R	28	LCK-EZS1115	25	LCK-MLK405	21	LPT-CY938026D	22
IND-94-E-4C	98	LCK-18200D	27	LCK-EZST10B	25	LCK-MLK411P	21	LPT-CY938026DS	22
IND-94-E-5C	97	LCK-18200SL	27	LCK-EZST3	25	LCK-MLLB9300	22	LPT-CY93803	22
IND-94-E-6C	97	LCK-18200SR	27	LCK-EZST32D	25	LCK-MLLB9300-L	22	LPT-CY93803S	22
IND-94-F-3C	97	LCK-18500	27	LCK-EZST5	25	LCK-NK4000LXL	27	LPT-CY93805	22
IND-94-F-4C	97	LCK-45100L	27	LCK-EZT6113	25	LCK-NK4000LXR	27	LPT-GL26D	24
IND-94-F-5C	97	LCK-45100R	27	LCK-EZT61132D	25	LCK-NK4000SDL	27	LPT-GL3	24
IND-94-F-6C	97	LCK-A13-115	29	LCK-EZT6115	25	LCK-NK4000SDR	27	LPT-GL5	24
IND-98-1C	84	LCK-A13-215	29	LCK-EZT63310B	25	LCK-RCY92523	22	LPT-K924226D	22
IND-FT12A	119	LCK-DC3	26	LCK-EZT6333	25	LCK-SC3	26	LPT-K92423	22
IND-FT16A	119	LCK-DC32D	26	LCK-EZT63332D	25	LCK-SC32D	26	LPT-K92425	22
IND-FT18A	119	LCK-DC3L	26	LCK-EZT6335	25	LCK-SC3L	26	LPT-LH937011P	22

INDEX

LPT-LH937026D	22	ORI-219	37	ORI-844	43	ORI-CSH114	42	ORI-RE199	44
LPT-LH93703	22	ORI-227-12	33	ORI-858S	37	ORI-CSH2	42	ORI-RE199L	44
LPT-LH93705	22	ORI-227-34	33	ORI-9H	34	ORI-HK-1	40	ORI-RE199XL	44
LPT-MK983026D	22	ORI-227-58	33	ORI-9Y	34	ORI-HK-12	40	ORI-RE201	44
LPT-MK98303	22	ORI-227X	38	ORI-9Z	36	ORI-HK-34	40	ORI-RE201L	44
LPT-MK98305	22	ORI-251-1	33	ORI-BCI1	43	ORI-HK-58	40	ORI-RE201XL	44
LPT-MLBTT26D	22	ORI-251-12	33	ORI-BCI112	43	ORI-L649H	34	ORI-RE6928	44
LPT-MLBTT3	22	ORI-251-34	33	ORI-BCI2	43	ORI-L649Y	34	ORI-RE6928L	44
LPT-MLBTT5	22	ORI-251-58	33	ORI-BCI34	43	ORI-L649Z	34	ORI-RE6928XL	44
LPT-SCY968010B	23	ORI-260-12	33	ORI-BH93R	45	ORI-L655	34	ORI-REC401L	50
LPT-SCY968026D	23	ORI-260-34	33	ORI-CIC141	39	ORI-L655H	34	ORI-REC401R	50
LPT-SCY96803	23	ORI-260-58	33	ORI-CIC142	39	ORI-L655Y	34	ORI-REC421L	50
LPT-SCY96805	23	ORI-270-12	34	ORI-CIC143	39	ORI-L656H	34	ORI-REC421R	50
LPT-SDT96353	23	ORI-270-34	34	ORI-CIC144	39	ORI-L656Y	34	ORI-REC441L	50
LPT-SDT96355	23	ORI-270-58	34	ORI-CIC145	39	ORI-L659H	34	ORI-REC441R	50
LPT-SLB9600	23	ORI-271-1	36	ORI-CIC146	39	ORI-L659Y	34	ORI-REL400L	50
LPT-TSCY968510B	23	ORI-272-1	36	ORI-CIC147	39	ORI-L659Z	34	ORI-REL400R	50
LPT-TSCY968526D	23	ORI-273-1	36	ORI-CIC148	39	ORI-P6000	51	ORI-REL420L	50
LPT-TSCY96853	23	ORI-413X	38	ORI-CIC149	39	ORI-P6002	51	ORI-REL420R	50
LPT-TSCY96855	23	ORI-414X	38	ORI-CIC150	39	ORI-P6031	51	ORI-REL440L	50
ORI-215-12	33	ORI-657P	51	ORI-CIC197	47	ORI-PB114	39	ORI-REL440R	50
ORI-215-34	33	ORI-657S	37	ORI-CIC198	47	ORI-PB115	39	ORI-S215-12	33
ORI-215-58	33	ORI-671AF	36	ORI-CIC21C	46	ORI-PB117	39	ORI-S215-34	33
ORI-215X	38	ORI-671XL	36	ORI-CIC22C	46	ORI-PB118H	39	ORI-S215-58	33
ORI-217-12	33	ORI-6732T	51	ORI-CIC23C	46	ORI-PB119H	39	ORI-S217-12	33
ORI-217-34	33	ORI-6906X	38	ORI-CIC6701	46	ORI-PB120H	39	ORI-S217-34	33
ORI-217-58	33	ORI-6914	34	ORI-CIC6702	46	ORI-PB121H	39	ORI-S217-58	33
ORI-217B-12	33	ORI-6914X	38	ORI-CIC6711	46	ORI-PB125	39	ORI-S217B-12	33
ORI-217B-34	33	ORI-810S	37	ORI-CIC6714	46	ORI-PB126	39	ORI-S217B-34	33
ORI-217B-58	33	ORI-812S	37	ORI-CIC6716	46	ORI-PB224	39	ORI-S217B-58	33
ORI-218-12	33	ORI-833	43	ORI-CIC6717	47	ORI-PB224112	39	ORI-S218-12	33
ORI-218-34	33	ORI-834S	37	ORI-CSH1	42	ORI-PB7X	38	ORI-S218-34	33
ORI-218-58	33	ORI-835	43	ORI-CSH112	42	ORI-PB7XL	38	ORI-S218-58	33

INDEX/CHARTS

ORI-S227-12	33	PLS-CAP1X112	20	PLS-P21512	20
ORI-S227-34	33	PLS-CAP1X112W	20	PLS-P217B12	20
ORI-S227-58	33	PLS-CAP1X2	20	PLS-P217B34	20
ORI-S251-1	33	PLS-CAP1X2W	20	PLS-P217B58	20
ORI-S251-12	33	PLS-CAP2	20	PLS-P227B12	20
ORI-S251-34	33	PLS-CAP2NW	20	PLS-P227B34	20
ORI-S251-58	33	PLS-CAP2W	20	PLS-P227B58	20
ORI-S260-12	33	PLS-CAP3	20		
ORI-S260-34	33	PLS-CAP3W	20		
ORI-S260-58	33	PLS-CAP34	20		
ORI-SH352	42	PLS-CAP34W	20		
ORI-SH353	42	PLS-CAP34X112	20		
ORI-SH354	42	PLS-CAP34X112W	20		
ORI-SH356	42	PLS-CAP58	20		
ORI-SH357	42	PLS-CAP58W	20		
ORI-SH653	45	PLS-CAPR1	20		
ORI-SH654	45	PLS-CAPR112	20		
ORI-SHCC	41	PLS-CAPR112W	20		
ORI-SHDD	41	PLS-CAPR114	20		
ORI-SHDD34	41	PLS-CAPR114W	20		
ORI-SHEE	41	PLS-CAPR12	20		
ORI-SHHH	41	PLS-CAPR12W	20		
ORI-SHLL	41	PLS-CAPR1W	20		
ORI-SHMM	41	PLS-CAPR2	20		
PLS-CAP1	20	PLS-CAPR2W	20		
PLS-CAP112	20	PLS-CAPR3	20		
PLS-CAP112W	20	PLS-CAPR34	20		
PLS-CAP114	20	PLS-CAPR34W	20		
PLS-CAP114W	20	PLS-CAPR3W	20		
PLS-CAP12	20	PLS-CAPR58	20		
PLS-CAP12W	20	PLS-CAPR58W	20		
PLS-CAP1NW	20	PLS-P21534	20		
PLS-CAP1W	20	PLS-P21558	20		

MATH CONVERSION CHART – WEIGHT (US)

METRIC CONVERSIONS			
1 gram	=	1000 milligrams	1g = 1000 mg
1 kilogram	=	1000 grams	1 kg = 1000 g
1 tonne (1 megagram)	=	1000 kilograms	1 tonne (1 Mg) = 1000 kg
STANDARD CONVERSIONS			
1 ounce	=	16 drams	1 oz = 16 dr
1 pound	=	16 ounces	1 lb = 16 oz
1 hundredweight	=	100 pounds	1 cwt = 100 lb
1 ton (short)	=	20 hundredweight	1 ton = 20 cwt
1 ton (short)	=	2000 pounds	1 ton = 2000 lb
METRIC -> STANDARD CONVERSIONS			
1 gram	=	0.035274 ounces	1 g = 0.035274 oz
1 kilogram	=	2.20462 pounds	1 kg = 2.20462 lb
1 kilogram	=	35.27396 ounces	1 kg = 35.27396 oz
1 tonne	=	1.10231 ton, short	1 tonne = 1.10231 ton, short
STANDARD -> METRIC CONVERSIONS			
1 ounce	=	28.34952 grams	1 oz = 28.34952 g
1 pound	=	453.59237 grams	1 lb = 453.59237 g
1 pound	=	0.45359 kilograms	1 lb = 0.45359 kg
1 hundredweight	=	50.8023 kilograms	1 cwt = 50.8023 kg