

TABLE OF CONTENTS

CAST IRON

CAST IRON SPEARS	1-5
CAST IRON DRIVE-INS	6
CAST IRON TOPS	7
CAST IRON COLLARS	8
CAST IRON SHOES	9-10
CAST IRON ROSETTES, RINGS, SPHERES	11
CAST IRON RAILENDS	12
CAST IRON BRACKETS	13
CAST IRON ORNAMENTAL CASTINGS	14-18
CAST IRON LATERALS AND CHANNELS	18
CAST IRON POSTS	19

ALUMINUM

ALUMINUM PICKETS	20-22
ALUMINUM ROSE DESIGN	23-24
ALUMINUM BIRDS OF PARADISE DESIGN	24
ALUMINUM OAK DESIGN	25
ALUMINUM GRAPE DESIGN	26
ALUMINUM LION DESIGN	27
ALUMINUM PALM TREE/EAGLE/HORSE DESIGN	28-29
ALUMINUM PONTALBA DESIGN	30
ALUMINUM CONTEMPORARY DESIGN	31
ALUMINUM IVY DESIGN	31
ALUMINUM STORM DOOR CASTINGS	32-33
ALUMINUM HANDRAIL BRACKETS	34
ALUMINUM SPEARS, CAPS, SHOES	35-36

DUCTILE IRON

DUCTILE IRON BALLS	37
DUCTILE IRON HANDRAIL BRACKETS	37
DUCTILE IRON BALUSTER	38-39
DUCTILE IRON PANELS	39
DUCTILE IRON SHOES	40-41
DUCTILE IRON RAILENDS	42

HARDWARE

HINGES	43
LOCK SETS - MORTISE	45
LOCK SETS - SLIMLINE MORTISE	46-47
LOCK SETS - DOOR	46-47
EZSET	48-49
LOCK SETS - CONCEALED	50
LOCK SETS - SNAP-IN DEADBOLT	50
LOCK SETS - GATE	50
LOCK SETS - HOOK	51
LOCK SETS - DIGITAL	51

TABLE OF CONTENTS

HARDWARE

LOCK BOXES	52-53
GATE HARDWARE	
ROLLERS	54
CANE BOLTS	54
WHEEL BOXES	54
BOLTS AND LATCHES	55
WHEELS AND TRACK WHEELS	56
MAIL SLOTS	57
CLOSERS	57-58
WINDOW RELEASE	59
TUBE BENDER	59
FASTENERS	60-61

METAL STAMPINGS

WELD TABS	60
BASE PLATES	61
BRACKETS	62-64
STEEL DISCS	65
BATWINGS	66
HANDRAIL BRACKETS	65
METAL RINGS	67
SPHERES	68
PRESSED STEEL POST CAPS	68

PLASTIC

PLASTIC POST CAPS	69
PLASTIC SPEARS	69

FITTINGS

PIPE FITTINGS	70
PIPE FLANGE	70

STEEL FORGINGS

BALUSTERS TWISTED DESIGN	71-73
BALUSTERS STAIR AND RAIL DESIGN	74-79
BALUSTERS ROUND DESIGN	80
STEEL TUBE COMPONENTS	81
FORGED NEWEL POSTS	82
BALCONY ELEMENTS	83

TUBING SCROLLS

FISHTAIL STYLE SCROLLS	84
------------------------	----

TABLE OF CONTENTS

SCROLL FORGINGS

SCROLLS - SNAP ON DESIGN	85
SCROLLS - FISH TAIL DESIGN	86-87
SCROLLS - LEAF DESIGNS	88
SCROLLS - TIGHT CURL HAMMERED DESIGN	89
SCROLLS - TIGHT CURL EDGE-GROOVED DESIGN	90
SCROLLS - LEAF DESIGN EDGE-GROOVED	91
SCROLLS - ROUND BAR DESIGN	92-93

DECORATIVE PANEL

DECORATIVE PANEL - ROSETTE DESIGN	94
DECORATIVE PANEL - PONTALBA DESIGN	95
DECORATIVE PANEL - HEART AND FLORAL DESIGN	96
DECORATIVE PANEL - SCROLL DESIGN	96-99

FORGINGS

FORGINGS – FLORAL ELEMENTS	100-102
FORGINGS - GRAPES	103

CAST STEEL ELEMENTS

CAST STEEL - SPEARS	104
CAST STEEL – FLORAL ELEMENTS	105-106

STAMPINGS

STAMPINGS – FLORAL ELEMENTS	107-108
PRESSED SHEET METAL – FLORAL ELEMENTS	109-112

SPHERES & BASKETS

SPHERES	113
BASKETS	113

DECORATIVE BAR

DECORATIVE FLAT BAR	114
DECORATIVE ROUND BAR	115
DECORATIVE TUBING	116
END PIECES FOR HANDRAILS	117-118

TERMS AND CONDITIONS

- TERMS OF PAYMENT:** NET 30 days with approved credit. 1-1/2% per month interest charge on past due balances. A \$25.00 service fee will be charged for each returned check.
- NEW ACCOUNTS:** New accounts will be shipped under C.O.D terms until credit application has been submitted and approved.
- PRICING:** All prices are subject to change without notice.
- FREIGHT:** Prices are F.O.B. Arcadia, California.
- LIMITED WARRANTY:** All our products are guaranteed against faulty workmanship and/or defective materials. Defective products will be replaced free of charge. Our liability and responsibility are limited to replacement of parts only. A high quality clear protective coating is applied to the exterior surface of our brass products. However, if exposed to corrosive vapors, humid climates, sea air or salt spray, this protective coating can be damaged rapidly. Therefore, finishes on metal surfaces will not be included in our limited warranty.
- RETURN POLICY:** The following is regarding all returned items to our warehouse.
- No returns will be accepted unless authorized by a representative of Cameron Enterprises Ltd. prior to return. Credit will be issued upon inspection of goods.
- We must be notified of a return within 15 days of purchase.
 - A restocking fee of 15% will apply on all returns.
 - No returns will be accepted after 30 days.
 - Must have an authorization number.
 - Must have packing list or invoice from original purchase
 - Must be in original packaging
 - Must use credit within 90 days.
- LOSS AND DAMAGES:** Any claim for loss or damage in transit must be made against the carrier that delivered upon receipt of orders. Damages or shortages must be reported within 2 working days of receipt.
- DISCLAIMER NOTICE:** Cameron Enterprises, Ltd. reserves the right to revise this catalog, its listings, descriptions, and illustrations as market conditions, company policy, or other conditions may require without additional notice.

CAST IRON SPEARS



ORI-215					
Sz	H	W	Base	Wgt	Pk
1/2"	4-1/4"	3"	1"	18 lbs.	50
5/8"	4-1/4"	3"	1-1/8"	18 lbs.	50
3/4"	4-1/8"	3-1/8"	1-1/8"	18 lbs.	50

ORI-S215 - ECONOLINE					
Sz	H	W	Base	Wgt	Pk
1/2"	4"	2"	3/4"	12 lbs.	50
5/8"	4"	2"	3/4"	12 lbs.	50
3/4"	4"	2"	7/8"	12 lbs.	50



ORI-227					
Sz	H	W	Base	Wgt	Pk
1/2"	4-1/4"	3"	1"	18 lbs.	50
5/8"	4-1/4"	3"	1-1/8"	18 lbs.	50
3/4"	4-1/8"	3-1/8"	1-1/8"	18 lbs.	50

ORI-S227 - ECONOLINE					
Sz	H	W	Base	Wgt	Pk
1/2"	4-3/4"	2-7/8"	1-1/8"	17 lbs.	50
5/8"	4-3/4"	2-7/8"	1-1/8"	17 lbs.	50
3/4"	4-3/4"	3"	1-1/8"	19 lbs.	50



ORI-217					
Sz	H	W	Base	Wgt	Pk
1/2"	4-1/8"	1-1/8"	1"	19 lbs.	70
5/8"	4-1/8"	1-1/8"	1"	20 lbs.	70
3/4"	4-1/8"	1-1/8"	1-1/8"	20 lbs.	70

ORI-S217 - ECONOLINE					
Sz	H	W	Base	Wgt	Pk
1/2"	4"	7/8"	15/16"	17 lbs.	70
5/8"	4"	7/8"	15/16"	17 lbs.	70
3/4"	4"	7/8"	15/16"	17 lbs.	70



ORI-260					
Sz	H	W	Base	Wgt	Pk
1/2"	5-1/4"	3-1/4"	3/4"	16 lbs.	30
5/8"	5-1/4"	3-1/4"	1"	16 lbs.	30
3/4"	5-1/2"	3-1/4"	1"	16 lbs.	30

ORI-S260 - ECONOLINE					
Sz	H	W	Base	Wgt	Pk
1/2"	4-3/4"	3-1/8"	7/8"	15 lbs.	45
5/8"	4-3/4"	3-1/4"	7/8"	15 lbs.	30
3/4"	4-3/4"	3-1/4"	7/8"	15 lbs.	30



ORI-217B					
Sz	H	W	Base	Wgt	Pk
1/2"	4-1/8"	1-1/8"	1"	19 lbs.	70
5/8"	4-1/8"	1-1/8"	1"	19 lbs.	70
3/4"	4-1/8"	1-1/8"	1-1/8"	20 lbs.	70

ORI-S217B - ECONOLINE					
Sz	H	W	Base	Wgt	Pk
1/2"	4"	7/8"	15/16"	16 lbs.	70
5/8"	4"	7/8"	15/16"	16 lbs.	70
3/4"	4"	7/8"	15/16"	16 lbs.	70



ORI-251					
Sz	H	W	Base	Wgt	Pk
1/2"	1-7/8"	1-1/8"	1"	18 lbs.	55
5/8"	1-3/4"	1-5/8"	1"	19 lbs.	48
3/4"	2-1/8"	2-1/8"	1-1/8"	18 lbs.	32
1"	2-3/8"	2-5/8"	1-1/8"	18 lbs.	22
1-1/2"				30 lbs.	18
2"				33 lbs.	16

ORI-S251 - ECONOLINE					
Sz	H	W	Base	Wgt	Pk
1/2"	1-13/16"	1-1/2"	1"	13 lbs.	55
5/8"	1-13/16"	1-3/4"	1"	13 lbs.	48
3/4"	1-7/8"	2"	1"	12 lbs.	32
1"	2-1/4"	2-1/2"	1"	28 lbs.	56



ORI-218					
Sz	H	W	Base	Wgt	Pk
1/2"	4"	2-1/4"	1"	16 lbs.	50
5/8"	4"	2-1/4"	1"	16 lbs.	50
3/4"	4"	2-1/4"	1"	16 lbs.	50

ORI-S218 - ECONOLINE					
Sz	H	W	Base	Wgt	Pk
1/2"	3-7/8"	2-1/8"	1-1/8"	12 lbs.	50
5/8"	3-7/8"	2-1/8"	1-1/8"	13 lbs.	50
3/4"	3-7/8"	2-1/2"	1-1/8"	13 lbs.	50

CAST IRON SPEARS



ORI-270			
Sz	1/2"	5/8"	3/4"
H	5-5/8"	5-5/8"	5-5/8"
W	2-1/2"	2-1/2"	2-1/2"
Base	1"	1-3/16"	1-3/8"
Wgt	22 lbs.	22 lbs.	22 lbs.
Pk	30	30	25



ORI-L659 (SQUARE FIT)			
Item#	L659H	L659Y	L659Z
Sz	5/8"	3/4"	1"
H	5-3/8"	6-3/4"	6"
W	3-1/2"	4-1/8"	4"
Base	1-1/16"	1-1/4"	1-1/2"
Wgt	34 lbs.	23 lbs.	25 lbs.
Pk	40	25	25



ORI-655			
Item#	655	655H	655Y
Sz	1/2"	5/8"	3/4"
H	6"	6"	6-1/2"
W	3-1/8"	3-1/8"	3-1/2"
Base	1-1/2"	1-5/8"	1-3/4"
Wgt	20 lbs.	20 lbs.	20 lbs.
Pk	15	15	15



ORI-6914 (ROUND FIT)	
Sz	1/2"
H	4"
W	1-3/4"
Base	3/4" O.D.
Wgt	22 lbs.
Pk	70



ORI-9 (SQUARE FIT)		
Item#	9H	9Y
Sz	5/8"	3/4"
H	4-1/2"	5-3/4"
W	1-1/8"	1-3/4"
Base	1-3/16"	1-1/4"
Wgt	20 lbs.	23 lbs.
Pk	40	15



CL-668 (SQUARE FIT)			
Item#	668	668H	668Y
Sz	1/2"	5/8"	3/4"
H	7"	7"	7"
W	3"	3"	3-1/8"
Base	1"	1-1/8"	1-1/8"
Wgt	32 lbs.	32 lbs.	32 lbs.
Pk	40	40	40



ORI-L649 - (SQUARE FIT)			
Item#	L649H	L649Y	L649Z
Sz	5/8"	3/4"	1"
H	4-1/2"	5-1/4"	6-1/4"
W	2-1/4"	2-5/8"	6-1/4"
Base	1-1/8"	1-1/8"	1-3/4"
Wgt	19 lbs.	25 lbs.	16 lbs.
Pk	35	30	11



ORI-L656 - (SQUARE FIT)		
Item#	L656H	L656Y
Sz	5/8"	3/4"
H	5-5/8"	6-3/4"
W	3-1/2"	4-1/8"
Base	1-1/16"	1-1/4"
Wgt	22 lbs.	23 lbs.
Pk	25	20



ORI-L649 shown.

CAST IRON SPEARS



CL-826 (SQUARE FIT)	
Sz	3/4"
H	7"
W	4"
Base	1-1/2"
Wgt	32 lbs.
Pk	30



CL-8832 shown.



CL-651 (ROUND FIT)	
Sz	1/2"
H	5-1/4"
W	4"
Base	1-1/8"
Wgt	40 lbs.
Pk	45



CL-831 (SQUARE FIT)			
Item#	831	831H	831Y
Sz	1/2"	5/8"	3/4"
H	5-3/8"	5-5/8"	5-5/8"
W	2-3/8"	2-3/8"	2-3/8"
Base	7/8"	1-1/4"	1-1/4"
Wgt	23 lbs.	24 lbs.	26 lbs.
Pk	40	40	40



CL-825 (SQUARE FIT)	
Sz	1/2"
H	4-3/4"
W	1-1/2"
Base	1-1/4" O.D.
Wgt	31 lbs.
Pk	65



CL-431 (SQUARE FIT)			
Item#	431	431H	431Y
Sz	1/2"	5/8"	3/4"
H	5-3/8"	5-5/8"	5-5/8"
W	2-3/8"	2-3/8"	2-3/8"
Base	1-1/4"	1-1/4"	1-1/4"
Wgt	24 lbs.	24 lbs.	24 lbs.
Pk	30	30	30



CL-9XS (SQUARE FIT)	
Sz	1/2"
H	3-1/2"
W	1"
Base	1"
Wgt	17 lbs.
Pk	50



CL-8832 (SQUARE FIT)			
Item#	8832	8832H	8832Y
Sz	1/2"	5/8"	3/4"
H	5-3/8"	5-5/8"	5-5/8"
W	2-3/8"	2-3/8"	2-3/8"
Base	1"	1-1/4"	1-1/4"
Wgt	24 lbs.	24 lbs.	24 lbs.
Pk	35	35	35



CL-7009 (SQUARE FIT)	
Sz	5/8"
H	5-3/4"
W	2-1/2"
Base	1-1/8"
Wgt	28 lbs.
Pk	30



CL-670 (SQUARE FIT)			
Item#	670	670H	670Y
Sz	1/2"	5/8"	3/4"
H	5-3/4"	5-5/8"	5-3/4"
W	3-5/8"	3-5/8"	3-5/8"
Base	1-1/8"	1-1/8"	1-1/8"
Wgt	20 lbs.	20 lbs.	20 lbs.
Pk	30	35	35

CAST IRON SPEARS



CL-8812 (SQUARE FIT)				
Item#	8812SM	8858	8834SM	8834
Sz	1/2"	5/8"	3/4"	3/4"
H	5"	4-7/8"	4-3/4"	5-3/4"
W	3"	3"	3"	3-1/2"
Base	1-1/8"	1-1/4"	1-1/2"	1-1/2"
Wgt	20 lbs.	20 lbs.	20 lbs.	40 lbs.
Pk	25	25	25	30



ORI-271-1 (SQUARE FIT)	
Sz	1"
H	7-1/4"
W	3"
Base	1-1/2"
Wgt	21 lbs.
Pk	25



CL-731 (SQUARE FIT)				
Item#	731	731H	731Y	731Z
Sz	1/2"	5/8"	3/4"	1"
H	6"	6"	6"	7"
W	3-1/8"	3-1/8"	3-1/8"	3-3/8"
Base	3/4"	1-1/8"	1-1/8"	1-1/2"
Wgt	17 lbs.	17 lbs.	17 lbs.	23 lbs.
Pk	30	30	30	30



ORI-272-1 (SQUARE FIT)	
Sz	1"
H	7-5/8"
W	2-3/4"
Base	1-1/2"
Wgt	22 lbs.
Pk	25



CL-853 (SQUARE FIT)					
Item#	853	85358	85334	853H	853Y
Sz	1/2"	5/8"	3/4"	5/8"	3/4"
H	4-1/2"	4-5/8"	4 5/8"	5-1/2"	6-5/8"
W	2-1/2"	2-5/8"	2-3/8"	3-1/4"	3-3/4"
Base	1-1/2"	1-5/8"	1-5/8"	1-3/4"	2"
Wgt	40 lbs.	20 lbs.	20 lbs.	22 lbs.	37 lbs.
Pk	40	40	25	20	20



ORI-273-1 (SQUARE FIT)	
Sz	1"
H	5-1/4"
W	4"
Base	2"
Wgt	40 lbs.
Pk	45 pcs.



ORI-671 (SQUARE FIT)		
Item#	671AF	671XL
Sz	3/4"	1"
H	5-1/8"	8-1/4"
W	1-5/8"	2"
Base	1-1/8"	1-1/2"
Wgt	36 lbs.	18 lbs.
Pk	30	10



ORI-9Z (SQUARE FIT)	
Sz	1"
H	7-7/8"
W	2-1/8"
Base	1-3/4"
Wgt	16 lbs.
Pk	10

CAST IRON SPEARS



CL-662 (SQUARE FIT)

Sz	1"
H	7-3/4"
W	2-3/4"
Base	1-5/8"
Wgt	37 lbs.
Pk	25



ORI-219

Sz	4"
H	7-3/4"
Base	1-1/4"
Wgt	34 lbs.
Pk	45 pc

ORI-810 - (SQUARE FIT PINEAPPLE)

Item#	810	812	858	834
Fit	1"	1/2"	5/8"	3/4"
H	3"	2"	2-1/4"	2-1/2"
W	1-1/2"	1"	1-3/16"	1-3/8"
Wgt	23 lbs.	28 lbs.	22 lbs.	24 lbs.
Pk	40	130	48	65



CL-8X - (URN)

H	3"
Base	1-1/2"
Wgt	31 lbs.
Pk	90



ORI-657S - PINEAPPLE

H	4-1/2"
W	2-1/4"
Base	1-3/4" RD
Wgt	29 lbs.
Pk	18



The pineapple is recognized as a traditional expression of welcome throughout the United States. Appearing on all sorts of décor, the fruit symbolizes intangible assets we appreciate in a home- warmth, welcome, friendship, and hospitality.

CAST IRON DRIVE INS



ORI-215X	
Fit	1" Sq
H	4-1/4"
W	2"
Base	1"
Wgt	20 lbs.
Pk	50



CL-661	
Fit	1" Sq
H	3-3/8"
W	1-3/8"
Base	1-1/8"
Wgt	35 lbs.
Pk	50



ORI-227X	
Fit	1" Sq
H	4-3/4"
W	3"
Base	1"
Wgt	19 lbs.
Pk	30



CL-670CF	
Fit	1" Sq
H	5-1/8"
W	4-3/8"
Base	1-1/4"
Wgt	33 lbs.
Pk	30



	ORI-413X	ORI-414X
Fit	1" Sq	1-1/4" Sq
H	3/4"	3/4"
Wgt	24 lbs.	30 lbs.
Pk	180	120



ORI-6906X	
Fit	1" Sq
H	2-3/4"
W	1-1/4"
Wgt	47 lbs.
Pk	60



	ORI-7X	ORI-7XL
Fit	1" Sq	1-1/4" Sq
Dia.	1"	1-1/2"
H	2-1/2"	3-1/2"
W	1-3/4"	1-3/4"
Wgt	34 lbs.	38 lbs.
Pk	110	30



ORI-6914X	
Fit	3/4" Sq
H	4-1/4"
W	2"
Wgt	24 lbs.
Pk	50

CAST IRON CAPS



CAST IRON POST BALL - SQUARE FIT

Item#	Sz	Dia	H	Wgt	Pc/box
ORI-PB115	1"	1-1/8"	2-1/2"	24 lbs.	60
ORI-PB114	1-1/4"	1-1/8"	2-1/2"	20 lbs.	40
ORI-PB117	1-1/2"	1-5/16"	2-3/4"	30 lbs.	42
ORI-PB118H	2"	1-15/16"	3-5/8"	12 lbs.	12
ORI-PB121H	2-1/2"	2-1/8"	4-1/8"	20 lbs.	8
ORI-PB120H	3"	2-1/2"	4-1/2"	12 lbs.	4
ORI-PB119H	4"	2-3/4"	5"	13 lbs.	3
ORI-PB125	5"	3-1/4"	5"	25 lbs.	4
ORI-PB126	6"	3-7/8"	7-1/2"	36 lbs.	4



CAST IRON POST BALL - SQUARE FIT

Item#	Sz	Base	Dia.	H	Wgt	Pk
ORI-PB224	1"	1-3/4"	1-5/16"	2-3/4"	34 lbs.	60
ORI-PB224114	1-1/4"	1-1/4"	1-1/2"	2-1/2"	36 lbs.	50
ORI-PB224112	1-1/2"	1-1/2"	1-1/2"	2-3/4"	31 lbs.	40



CAST IRON POST BALL - ROUND FIT

Item#	Sz (in.)	Base (in.)	Dia. (in.)	H (in.)	Wgt (lbs.)	Pc/box
CL-9536	5/8"	1-3/4"	2-1/4"	3-1/8"	24 lbs.	20
CL-9537	3/4"	2-1/4"	2-7/8"	4"	19 lbs.	16
CL-9538	1"	2-7/8"	3-11/16"	5-1/4"	27 lbs.	9

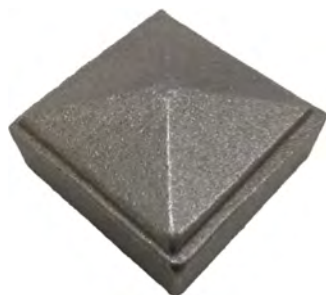

CAST IRON PYRAMID CAP

Item#	Sz	H	Wgt	Pk
ORI-CIC141	1"	3/4"	27 lbs.	200
ORI-CIC142	1-1/2"	1"	21 lbs.	80
ORI-CIC143	2"	1"	19 lbs.	48
ORI-CIC144	3"	1-1/2"	18 lbs.	20
ORI-CIC145	4"	1-1/2"	15 lbs.	10
ORI-CIC146	1-1/4"	3/4"	28 lbs.	104
ORI-CIC147	2-1/2"	1-1/2"	20 lbs.	30
ORI-CIC150	5"	2"	28 lbs.	10
ORI-CIC149	6"	2"	28 lbs.	8
ORI-CIC148	9"	2-7/8"	45 lbs.	4

CAST IRON COLLARS



CL660 - ROUND FIT			
Item#	CL66012	CL66058	CL66034
Sz	1/2"	5/8"	3/4"
H	2-5/8"	2-5/8"	2-5/8"
W	2-1/4"	2-1/4"	2-5/8"
Wgt	40 lbs.	32 lbs.	38 lbs.
Pk	60	60	60



CL612 - SQUARE FIT		
Item#	CL612	CL61258
Sz	1/2"	5/8"
H	1-1/2"	1-9/16"
W	1-3/4"	1-7/8"
Wgt	18 lbs.	23 lbs.
Pk	50	50



CL8127 - ROUND FIT				
#	CL8127	CL8587	CL8347	CL8117
Sz	1/2"	5/8"	3/4"	1"
H	1-5/16"	1-7/16"	1-1/2"	1-7/8"
W	1-1/2"	1-5/8"	1-15/16"	2-1/4"
Wgt	16 lbs.	20 lbs.	15 lbs.	20 lbs.
Pk	100	80	60	40



CL8518 - SQUARE FIT		
Item#	CL8518	CL851858
Sz	1/2"	5/8"
H	1-3/4"	1-3/4"
W	1-7/8"	2"
Wgt	20 lbs.	25 lbs.
Pk	40	50

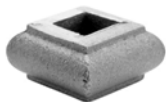

CL8521 - SQUARE FIT	
Sz	1/2"
H	3/4"
W	1-1/4"
Wgt	18 lbs.
Pk	200



CL8526 - SQUARE FIT				
Item#	CL8526	CL8526H	CL8526Y	CL8526Z
Sz	1/2"	5/8"	3/4"	1"
H	1-5/8"	1-7/8"	1-7/8"	2-1/4"
W	1-5/8"	1-7/8"	2-1/8"	2-5/8"
Wgt	35 lbs.	28 lbs.	27 lbs.	20 lbs.
Pk	80	50	40	20



CL8527 - SQUARE FIT			
Item#	CL8527	CL8527H	CL8527Y
Sz	1/2"	5/8"	3/4"
H	1-7/8"	1-7/8"	1-7/8"
W	1-3/16"	1-1/4"	2"
Wgt	23 lbs.	29 lbs.	31 lbs.
Pk	100	100	100



CAST IRON HALF KNUCKLE				
Item#	ORIHK12	ORIHK58	ORIHK34	ORIHK1
Sz	1/2"	5/8"	3/4"	1"
H	2"	1-7/8"	1-7/8"	2-1/2"
W	1-1/2"	1-5/8"	1-7/8"	2-1/2"
Wgt	27 lbs.	25 lbs.	26 lbs.	13 lbs.
Pk	85	70	55	20

CAST IRON SHOES



ORI - SHLL	
Fit	1" SQ Tubing
Ears	1
Depth	1-3/8"
W	2-3/8"
Wgt	25 lbs.
Pk	55



ORI - SHMM	
Fit	1" SQ Tubing
Ears	1
Depth	1-3/8"
W	2-3/8"
Wgt	17 lbs.
Pk	45



ORI - SHDD		
Item#	DD	DD34
Sz	1"	3/4"
Depth	2"	2"
Wgt	32 lbs.	25 lbs.
Pk	64	52



ORI - SHEE	
Fit	1/2" SQ Tubing
Ears	2
Depth	1"
Base	2-1/4" SQ
Wgt	17 lbs.
Pk	120



ORI - SHCC	
Fit	1" SQ Tubing
Ears	Flanged
Depth	2"
Base	3-1/4" SQ
Wgt	21 lbs.
Pk	22

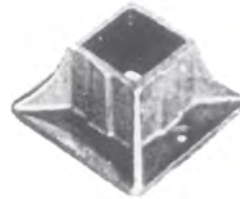

ORI - SHHH	
Fit	1-1/2" Sq Tubing
Ears	2
Depth	2"
Base	2-1/2" SQ
Wgt	12 lbs.
Pk	8



CL - SHBB	
Fit	1" SQ Tubing
Ears	2
Depth	1-1/4"
Base	2-1/4" SQ
Wgt	46 lbs.
Pk	75



CL - SHRR	
Fit	1-1/4" SQ Tubing
Ears	2
Depth	1-1/4"
Base	2-1/2" SQ
Wgt	33 lbs.
Pk	50

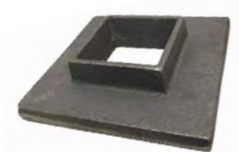

CL - SHKK2	
Fit	2" Sq. Tubing
Depth	1"
Base	4-7/8" SQ
Wgt	46 lbs.
Pk	20

CAST IRON SHOES



CAST IRON SHOE - SQUARE FIT

Item#	CL9503	CL9503-58
Sz	1/2"	5/8"
H	7/8"	7/8"
W	1-1/2"	1-1/2"
Pk	160	160
Wgt	24 lbs.	27 lbs.



CAST IRON SHOE - ROUND FIT

Item#	CLHK8127	CLHK8587	CLHK8347
Sz	1/2"	5/8"	3/4"
H	3/4"	3/4"	1"
W	1-1/4"	1-1/2"	1-3/4"
Pk	150	100	80
Wgt	19 lbs.	15 lbs.	15 lbs.

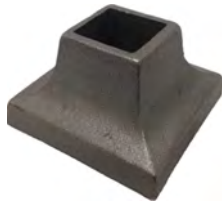

CAST IRON COVER SHOE - (ORI-CSH)

Item#	CSH1	CSH114	CSH112	CSH2
Sz	1"	1-1/4"	1-1/2"	2"
H	1-7/8"	1-7/8"	2"	2"
W	3-3/8"	3-1/2"	3-1/2"	4-5/8"
Pk	25	25	25	25
Wgt	19 lbs.	20 lbs.	21 lbs.	34 lbs.
Sq. Fit	3"	3"	3"	4"



CAST IRON SHOE - ROUND FIT

Item#	ORI-SH356	ORI-SH357
Sz	1/2"	5/8"
H	1"	1-3/16"
W	1-1/4"	1-3/8"
Pk	150	90
Wgt	22 lbs.	20 lbs.



CSH1 depicted.



CAST IRON SHOE - SQUARE FIT

Item#	ORI-SH352	ORI-SH353	ORI-SH354
Sz	1/2"	5/8"	3/4"
H	1-1/16"	1-1/16"	1-1/16"
W	1-1/4"	1-1/4"	1-3/8"
Pk	120	120	100
Wgt	32 lbs.	25 lbs.	30 lbs.

CAST IRON ROSETTES, RINGS, SPHERES



CL681		
Item#	CL681SF	CL681DF
Faces	Single	Double
Dia.	4"	4"
Wgt	22 lbs.	27 lbs.
Pk	45	15



CAST IRON BALL (ORI-BCI)				
Item#	BCI-134	BCI-1	BCI-112	BCI-2
Sz	3/4"	1"	1-1/2"	2"
Pk	500	250	50	25
Wgt	32 lbs.	25 lbs.	30 lbs.	26 lbs.



CL9050		
Item#	CL9050SF	CL9050DF
Faces	Single	Double
Dia.	3"	3"
Wgt	32 lbs.	23 lbs.
Pk	130	100



CL9052		
Item#	CL9052SF	CL9052DF
Faces	Single	Double
Dia.	2-5/8"	2-5/8"
Wgt	28 lbs.	33 lbs.
Pk	100	80



CE63102 depicted



CL9053	
Item#	CL9053SF
Faces	Single
Dia.	4"
Wgt	22 lbs.
Pk	45



CL9054		
Item#	CL9054SF	CL9054DF
Faces	Single	Double
Dia.	3"x2"	3"x2"
Wgt	31 lbs.	35 lbs.
Pk	100	70



BEVELED CAST IRON RING			
Item#	ORI833	ORI844	ORI835
O.D.	3"	4"	5-1/4"
Pk	44	50	20
Wgt	25 lbs.	45 lbs.	23 lbs.

CAST IRON RAIL ENDS



CAST IRON RAIL END	
Item#	CL-5A
Length	4-1/2"
Wgt	22 lbs.
Pk	50



MOLDED LAMBS TONGUE			
Item#	ORI-RE199	ORI-RE199L	ORI-RE199XL
Sz	1-3/4"	2"	2-1/4"
H	5"	4-1/2"	5"
Wgt	22 lbs.	54 lbs.	28 lbs.
Pk	20	30	12



CAST IRON RAIL END	
Item#	CL-5LT
Length	5-3/4"
Wgt	44 lbs.
Pk	50



MOLDED LAMBS TONGUE			
Item#	ORI-RE6928	ORI-RE6928L	ORI-RE6928XL
Sz	1-3/4"	2"	2-1/4"
H	5-1/2"	5-1/2"	5-3/8"
Wgt	19 lbs.	52 lbs.	35 lbs.
Pk	20	35	24



CAST IRON RAIL END	
Item#	CL-6LT
Length	6"
Wgt	33 lbs.
Pk	50



MOLDED VOLUTES			
Item#	ORI-RE201	ORI-RE201L	ORI-RE201XL
Sz	1-3/4"	2"	2-1/4"
H	2-5/8"	2-5/8"	2-5/8"
W	4"	4"	4-3/4"
Wgt	30 lbs.	50 lbs.	23 lbs.
Pk	30	25	15

TUBULAR RAIL ENDS



CL-902	
Item#	CL-902
Length	1-3/4"x4-1/4"
Wgt	36 lbs.
Pk	30



CL-7056	
Item#	CL-7056
Length	1-3/4"x1"
Wgt	36 lbs.
Pk	50



CL-901	
Item#	CL-901
Length	1-2/3"x3-1/2"
Wgt	30 lbs.
Pk	35



CL-900	
Item#	CL-900
Length	2-5/8"x2-1/4"
Wgt	42 lbs.
Pk	30

TUBULAR RAIL ENDS



ORI-SH654

Fit	1" Channel
Ears	1
Height	2-3/4"
Width	2-5/16"
Wgt	44 lbs.
Pk	44



ORI-SH653

Fit	1" Channel
Ears	1
Depth	2-1/8"
W	1-3/4"
Wgt	28 lbs.
Pk	150



CL3A depicted.

CAST IRON BRACKETS



CL-BH3A

Fit	Sq Fit
H	2-3/4"
W	2-1/2"
Hole Sz.	3/8"
Extend.	2-1/2"
Wgt	38 lbs.
Pk	50

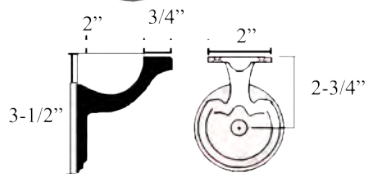

CL-BH3B

Fit	Sq Fit
H	3-1/2"
W	2-1/2"
B	2-1/2" Dia.
Hole Sz.	3/8"
Extend.	3"
Wgt	32 lbs.
Pk	50

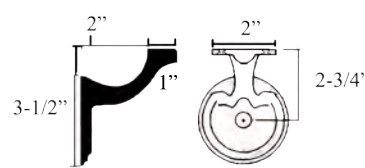

ORI-BH93R

Fit	Sq Fit
H	3-1/2"
W	2"
B	2-1/2"
Hole Sz.	3/8"
Extend.	2-1/2"
Wgt	16 lbs.
Pk	20

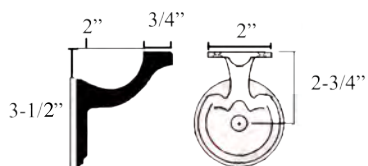

CL-BH3HRB

Fit	Sq Fit
H	5"
W	2-3/4"
Hole Sz.	3-3/4"
Extend.	3-1/2"
Wgt	33 lbs.
Pk	20

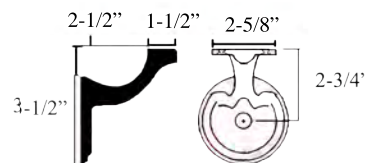

CAST IRON ORNAMENTAL CASTING



ORI-CIC21C	
Fit	1/2"
Height	14-7/8"
Width	7-1/2"
Pk	5
Weight	25 lbs.



ORI-CIC6702	
Fit	1/2"
Height	14-7/8"
Width	7-5/8"
Pk	10
Weight	23 lbs.



ORI-CIC22C	
Fit	1/2"
Height	16"
Width	7-1/2"
Pk	5
Weight	27 lbs.



ORI-CIC6711	
Fit	1/2"
Height	13-1/2"
Width	7-1/4"
Pk	10
Weight	20 lbs.



ORI-CIC23C	
Fit	1/2"
Height	15-1/4"
Width	7-1/4"
Pk	5
Weight	25 lbs.



ORI-CIC6714	
Fit	1/2"
Height	3-3/4"
Width	3-3/4"
Pk	25
Weight	18 lbs.



ORI-CIC6701	
Fit	1/2"
Height	14-1/8"
Width	6-1/2"
Pk	10
Weight	22 lbs.



ORI-CIC6716	
Fit	1/2"
Height	13-1/4"
Width	6-3/4"
Pk	10
Weight	23 lbs.

CAST IRON ORNAMENTAL CASTING



ORI-CIC198	
Height	7"
Width	4"
Pk	20
Weight	23 lbs.



CL-440	
Height	4"
Width	5-3/8"
Pk	80
Weight	46 lbs.



CL-145	
Fit	1/2"
Height	7-3/4"
Width	6-3/4"
Pk	12
Weight	20 lbs.



ORI-CIC6717	
Fit	1/2"
Height	17-7/8"
Width	7-1/2"
Pk	10
Weight	30 lbs.



ORI-CIC197	
Height	9"
Width	6-3/4"
Pk	22
Weight	25 lbs.



CL-89BXL	
Dia.	1"
Height	36"
Width	1" to 2-1/4"
Pk	5
Weight	60 lbs.



CL-A3	
Height	4"
Width	31-5/8"
Pk	5
Weight	34 lbs.

CAST IRON ORNAMENTAL CASTING



CL-22	
Height	20-1/4"
Width	8"
Pk	5
Weight	28 lbs.



CL-34	
Fit	1/2"
Height	10-1/4"
Width	8-1/4"
Pk	25
Weight	52 lbs.



CL-23A	
Height	16-1/8"
Width	16-1/8"
Pk	5
Weight	42 lbs.



CL-35	
Fit	1/2"
Height	15-1/2"
Width	8-1/4"
Pk	5
Weight	15 lbs.



CL-32	
Fit	1/2"
Height	16-1/8"
Width	8-3/4"
Pk	5
Weight	20 lbs.



CL-65	
Height	18-1/2"
Width	7"
Pk	5
Weight	30 lbs.



CL-679XL	
Fit	1/2"
Height	6-1/2"
Width	8-1/4"
Pk	25
Weight	50 lbs.



CL-74X	
Height	18-1/2"
Width	18"
Pk	5
Weight	40 lbs.

CAST IRON ORNAMENTAL CASTING



CL-80C	
Height	15-1/2"
Width	15-1/2"
Pk	5
Weight	36 lbs.



CL-85	
Height	24-3/4"
Width	8-1/8"
Pk	5
Weight	65 lbs.



CL-81	
Height	15-1/2"
Width	8-1/2"
Pk	5
Weight	42 lbs.



CL-A2	
Height	4-1/8"
Width	25-5/8"
Pk	5
Weight	29 lbs.



CL-82	
Height	22"
Width	8-1/2"
Pk	5
Weight	55 lbs.



CL-8333	
Fit	1/2"
Height	17"
Width	6-3/4"
Pk	5
Weight	13 lbs.



CE-6711 & CL-A2 depicted.

CAST IRON ORNAMENTAL CASTING



CL-A to Z & CL-N1 to 9	
Height	5"
Pk	10
Weight	3 lbs.



CL-100	
Height	12-1/2"
Width	31"
Pk	1
Weight	15 lbs.



ORI-REL400-L (right) / ORI-REL400-R (right)

CAST IRON RAIL END LATERAL - TOP

Item #	Size	H	W	Wgt.	Pk
ORI-REL400-R/L	1-3/4"	10"	12"	16 lbs.	5
ORI-REL420-R/L	2"	9"	11-3/8"	22 lbs.	5
ORI-REL440-R/L	2-1/4"	10"	12-1/4"	30 lbs.	5
DUC-REL400-R/L	1-3/4"	10"	12"	16 lbs.	5
DUC-REL420-R/L	2"	9"	11-3/8"	22 lbs.	5
DUC-REL440-R/L	2-1/4"	10"	12"	30 lbs.	5

*All items are available in malleable iron versions.



ORI-REC401-L (left) / ORI-REC401-R (right)

CAST IRON RAIL END CHANNEL - BOTTOM

Item #	Size	H	W	Wgt.	Pk
ORI-REC401-R/L	1-3/4"	10-1/2"	12-1/4"	11 lbs.	5
ORI-REC421-R/L	2"	8-1/2"	10-1/2"	13 lbs.	5
ORI-REC441-R/L	2-1/4"	10"	11-1/2"	15 lbs.	5
DUC-REC401-R/L	1-3/4"	10-1/2"	12-1/4"	11 lbs.	5
DUC-REC421-R/L	2"	8-1/2"	10-1/2"	13 lbs.	5
DUC-REC441-R/L	1-3/4"	10"	11-1/2"	15 lbs.	5

*All items are available in malleable iron versions.

CAST IRON POSTS



ORI-657P	
Height	7"
Width	3-3/8"
Pk	12
Weight	41 lbs.



ORI-P6000	
Height	27-5/8"
Top Width	5-1/4"
Base Width	6-1/2"
I.Dia.	2-1/2"
Pk	Each
Weight	28 lbs.



ORI-6732T (FOR 6031)	
Height	9"
Width	6-1/2"
Pk	1 SET
Weight	21 lbs.



ORI-P6031	
Height	28"
I.Dia.	4-1/2"
Pk	1 Set
Weight	102 lbs



Shown: ORI-P6000

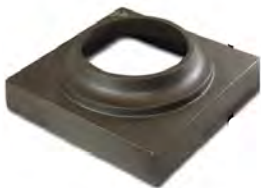

ORI-P6002	
Fit	Base for 6031
Width	10" Sq.
Pk	Each
Weight	10 lbs/pc

ALUMINUM PICKET CASTINGS



AL-2

Height: 16-1/2"
 Width: 7-1/8"
 Double Faced
 Packed 40 pcs/box
 Weight 40 lbs/box
 Available in 1/2", 5/8", 3/4"
 Available w/Screwholes
 Available in White/Black



AL-13

Height: 8-1/4"
 Width: 6-5/8"
 Double Faced
 Packed 40 pcs/box
 Weight 22 lbs/box
 Available in 1/2"



AL-3

Height: 12-7/8"
 Width: 6-3/4"
 Single Faced
 Packed 40 pcs/box
 Weight 40 lbs/box
 Available in 1/2", 5/8", 3/4"
 Available w/Screwholes
 Available in White/Black



AL-21

Height: 15"
 Width: 7-1/2"
 Double Faced
 Packed 20 pcs/box
 Weight 37 lbs/box
 Available in 1/2", 5/8", 3/4"



AL-8

Height: 4"
 Width: 4"
 Single Faced
 Packed 200 pcs/box
 Weight 52 lbs/box
 Available in 1/2", 5/8", 3/4"
 Available w/Screwholes
 Available in White/Black



AL-23

Height: 16-7/8"
 Width: 7-3/4"
 Double Faced
 Packed 20 pcs/box
 Weight 38 lbs/box
 Available in 1/2", 5/8", 3/4"
 Available w/Screwholes



AL-12

Height: 12-5/8"
 Width: 6-3/4"
 Double Faced
 Packed 40 pcs/box
 Weight 36 lbs/box
 Available in 1/2"
 Available w/Screwholes



AL-107

Height: 15-1/2"
 Width: 7-1/4"
 Double Faced
 Packed 20 pcs/box
 Weight 27 lbs/box
 Available in 1/2", 5/8", 3/4"

ALUMINUM PICKET CASTINGS



AL-192

Height: 13-3/8"
 Width: 7-1/8"
 Double Faced
 Packed 40 pcs/box
 Weight 38 lbs/box
 Available in 1/2", 5/8", 3/4"



AL-03038

Height: 18"
 Width: 6-1/2"
 Single Faced
 Packed 20 pcs/box
 Weight 27 lbs/box
 Available in 1/2", 5/8"
 Available w/ Screwholes



AL-196

Height: 6"
 Width: 7-1/2"
 Single Faced
 Packed 80 pcs/box
 Weight 45 lbs/box
 Available in 1/2"



AL-03039

Height: 18-1/2"
 Width: 6-3/4"
 Single Faced
 Packed 20 pcs/box
 Weight 30 lbs/box
 Available in 1/2", 5/8"
 Available w/ Screwholes



AL-244

Height: 6-5/8"
 Width: 5-1/2"
 Double Faced
 Packed 80 pcs/box
 Weight 52 lbs/box
 Available in 1/2", 5/8", 3/4"



AL-03068

Height: 13-7/8"
 Width: 7-1/2"
 Single Faced
 Packed 20 pcs/box
 Weight 33 lbs/box
 Available in 1/2"
 Available w/ Screwholes



AL-245

Height: 16"
 Width: 6-1/2"
 Double Faced
 Packed 30 pcs/box
 Weight 41 lbs/box
 Available in 1/2", 5/8", 3/4"
 Available w/ Screwholes



AL-187

Height: 8-1/2"
 Width: 4-3/4"
 Single Faced
 Packed 80 pcs/box
 Weight 57 lbs/box
 Available in 1/2", 5/8", 3/4"

ALUMINUM PICKET CASTINGS



AL-252

Height: 21-1/4"
 Width: 8-1/4"
 Packed 20 pcs/box
 Weight 48 lbs/box
 Available in 1/2", 5/8", 3/4"

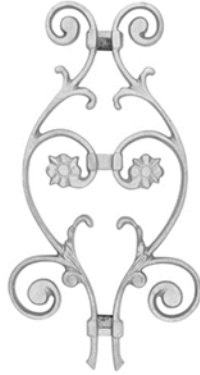

AL-26

Height: 15-1/4"
 Width: 8"
 Double faced
 Packed 20 pcs/box
 Weight 35 lbs/box
 Available in 1/2"

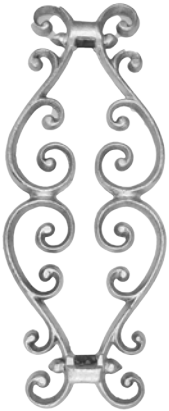

AL-275

Height: 14-1/2"
 Width: 5-5/8"
 Packed 20 pcs/box
 Weight 26 lbs/box
 Available in 1/2", 5/8", 3/4"



AL-1

Height: 14"
 Width: 6-3/8"
 Packed 40 pcs/box
 Weight 40 lbs/box
 Available in 1/2"



AL-21SF

Height: 16-1/4"
 Width: 8-1/4"
 Single Face
 Packed 20 pcs/box
 Weight 42 lbs/box
 Available in 1/2"
 Available w/ Screwholes &/or
 No tabs



AL-5

Height: 14-3/8"
 Width: 7-1/4"
 Packed 40 pcs/box
 Weight 42 lbs/box
 Available in 1/2"



AL-27

Height: 9"
 Width: 7"
 Double faced
 Packed 60 pcs/box
 Weight 45 lbs/box
 Available in 1/2"

ALUMINUM CASTINGS

ROSE DESIGN



AL-101

Height: 10-1/4"
Width: 25-1/4"
Packed 10 pcs/box
Weight 52 lbs/box
With Weld Tabs



AL-107

Height: 15-1/2"
Width: 6-5/16"
Packed 20 pcs/box
Weight 27 lbs/box
With Weld Tabs
Available in 1/2", 5/8", 3/4"



AL-102

Height: 14-1/8"
Width: 8-1/2"
Packed 20 pcs/box
Weight 42 lbs/box
With Weld Tabs



AL-103

Height: 13-5/16"
Width: 7-3/8"
Packed 20 pcs/box
Weight 35 lbs/box
With Weld Tabs
Available in 1/2", 5/8"



AL-105

Height: 28"
Width: 8-3/8"
Packed 10 pcs/box
Weight 41 lbs/box
With Weld Nuts



AL-110

Height: 8-1/2"
Width: 18-1/2"
Packed 20 pcs/box
Weight 33 lbs/box
With Weld Tabs



AL-106

Height: 20-3/8"
Width: 6-3/8"
Packed 20 pcs/box
Weight 37 lbs/box
With Weld Nuts



AL-113

Height: 23-3/4"
Width: 7-3/8"
Packed 20 pcs/box
Weight 54 lbs/box
With Weld Nuts

ALUMINUM CASTINGS



AL-109

Height: 22-1/2"
 Width: 8-1/2"
 Packed 10 pcs/box
 Weight 43 lbs/box
 With Weld Tabs



AL-115B

Height: 15-1/4"
 Width: 15-1/4"
 Packed 20 pcs/box
 Weight 41 lbs/box
 With Weld Tabs



AL-156

Height: 4-5/8"
 Width: 21-3/4"
 Packed 20 pcs/box
 Weight 38 lbs/box
 With Weld Nuts



AL-181

Height: 22-1/2"
 Width: 8-1/2"
 Packed 10 pcs/box
 Weight 43 lbs/box
 With Weld Tabs



AL-182

Height: 16-7/8"
 Width: 7-3/4"
 Double Faced
 Packed 20 pcs/box
 Weight 38 lbs/box
 Available in 1/2", 5/8", 3/4"



AL-183

Height: 25-1/4"
 Width: 8-1/2"
 Packed 10 pcs/box
 Weight 53 lbs/box
 With Weld Tabs



AL-190S

Height: 10"
 Width: 20-3/4"
 Packed 10 pcs/box
 Weight 21 lbs/box
 With Weld Nuts



AL-258

Height: 4-1/4"
 Width: 21-1/4"
 Packed 20 pcs/box
 Weight 39 lbs/box
 With Weld Nuts

ALUMINUM CASTINGS

OAK DESIGN



AL-154

Height: 16-1/2"
Width: 16-1/2"
Packed 20 pcs/box
Weight 55 lbs/box
With Weld Nuts

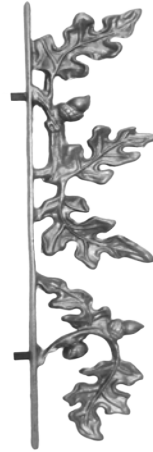

AL-158

Height: 4-1/4"
Width: 21-5/8"
Packed 20 pcs/box
Weight 29 lbs/box
With Weld Tabs



AL-124

Height: 27-3/4"
Width: 8-3/8"
Packed 10 pcs/box
Weight 46 lbs/box
With Weld Nuts



AL-148

Height: 26-1/4"
Width: 10-3/4"
Packed 10 pcs/box
Weight 41 lbs/box
With Weld Tabs



AL-151

Height: 20"
Width: 7-3/4"
Packed 10 pcs/box
Weight 26 lbs/box
With Weld Nuts



AL-21

Height: 15"
Width: 7-1/2"
Double Faced
Packed 20 pcs/box
Weight 37 lbs/box
With Weld Tabs
Available in 1/2", 5/8", 3/4"

ALUMINUM CASTINGS



AL-119

Height: 26"
Width: 8"
Packed 10 pcs/box
Weight 44 lbs/box
With Weld Nuts



AL-120

Height: 27-1/2"
Width: 7-5/8"
Packed 10 pcs/box
Weight 38 lbs/box
With Weld Nuts



AL-23

Height: 16-1/4"
Width: 7-5/8"
Packed 20 pcs/box
Weight 36 lbs/box
With Weld Tabs
In 1/2", 5/8", 3/4"



AL-130

Height: 20-3/8"
Width: 7-1/8"
Packed 20 pcs/box
Weight 44 lbs/box
With Weld Nuts



AL-122

Height: 12"
Width: 29-1/2"
Packed 10 pcs/box
Weight 60 lbs/box
With Weld Nuts



AL-560

Height: 7-3/4"
Width: 7-3/4"
Packed 20 pcs/box
Weight 28 lbs/box
With Weld Tabs



AL-564

Height: 21-1/2"
Width: 4"
Packed 20 pcs/box
Weight 33 lbs/box
With Weld Tabs

ALUMINUM CASTINGS



AL-552

Height: 25-1/2"
 Width: 8-3/4"
 Packed 10 pcs/box
 Weight 49 lbs/box
 With Weld Tabs



AL-270

Height: 27-1/8"
 Width: 12"
 Packed 10 pcs/box
 Weight 48 lbs/box
 With Weld Tabs



AL-247

Height: 29"
 Width: 8"
 Packed 10 pcs/box
 Weight 35 lbs/box
 With Weld Nuts

Symbolism involving the grapevine dates back thousands of years, when the ancient Greek used the grapevine as a symbol of fertility and prosperity. Our Grape or Vineyard castings continue this tradition.

LION DESIGN



Right



Left

AL-762

Height: 10-1/2"
 Width: 8"
 Packed 20 pcs/box
 Weight: 38 lbs/box
 Left and Right
 With Weld Tabs



Right



Left

AL-1000

Height: 29-1/2"
 Width: 14-1/4"
 Packed 5 pcs/box
 Weight: 44 lbs/box
 Left and Right
 With Weld Tabs

ALUMINUM CASTINGS



AL-3702



AL-3703

AL-3702 & AL-3703

Height: 23"
Width: 13-3/4"
Packed 10 pcs/box
Weight 30.7 lbs/box
Single faced

AL-3702 Left facing
AL-3703 Right Facing



AL-3705



AL-3706

AL-3705 & AL-3706

Height: 14-7/8"
Width: 9-1/2"
Packed 10 pcs/box
Weight 31 lbs/box
Single faced

AL-3705 Left facing
AL-3706 Right Facing



AL-3711



AL-3712

AL-3711 & AL-3712

Height: 15-3/8"
Width: 5-5/8"
Packed 40 pcs/box
Weight 47.6 lbs/box
Single faced

AL-3711 Left facing
AL-3712 Right Facing

“The palm branch is a symbol of victory, triumph, peace, and eternal life originating in the ancient Near East and Mediterranean world.”

ALUMINUM CASTINGS



AL-61

Height: 7"
Width: 16-3/8"
Packed 20 pcs/box
Weight 19.3 lbs/box
Single faced



AL-62

Height: 5-1/2"
Width: 19-1/2"
Packed 20 pcs/box
Weight 22.3 lbs/box
Single faced



AL-63

Height: 9-3/4"
Width: 26-3/8"
Packed 10 pcs/box
Weight 26 lbs/box
Single faced

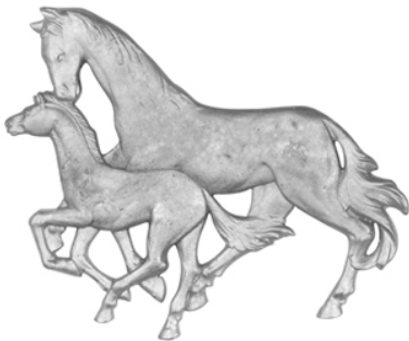

AL-718

Height: 14"
Width: 16-5/8"
Packed 10 pcs/box
Weight 38.4 lbs/box
Single faced



AL-717

Height: 19"
Width: 36"
Packed 10 pcs/box
Weight 56 lbs/box
Single faced

ALUMINUM CASTINGS



AL-135

Height: 19-1/8"
Width: 6-1/2"
Packed 20 pcs/box
Weight 36 lbs/box
With Weld Tabs



AL-142

Height: 16-3/4"
Width: 7-1/4"
Packed 40 pcs/box
Weight 50 lbs/box
With Weld Nuts



AL-134

Height: 25-1/2"
Width: 8-1/2"
Packed 10 pcs/box
Weight 41 lbs/box
With Weld Tabs



AL-146

Height: 22-1/2"
Width: 11-1/4"
Packed 10 pcs/box
Weight 42 lbs/box
With Weld Nuts



AL-138

Height: 26"
Width: 7-1/4"
Packed 10 pcs/box
Weight 44 lbs/box
With Weld Tabs



AL-M2 depicted.

ALUMINUM CASTINGS

IVY LEAF DESIGN



AL-216

Height: 5"
Width: 18-3/4"
Packed 20 pcs/box
Weight 24 lbs/box
With Weld Tabs



AL-117

Height: 30"
Width: 8"
Packed 10 pcs/box
Weight 61 lbs/box
With Weld Nuts



AL-48

Height: 15"
Width: 8"
Packed 20 pcs/box
Weight 27 lbs/box
With Weld Tabs



AL-176

Height: 13-1/4"
Width: 16-3/4"
Packed 20 pcs/box
Weight 36 lbs/box
With Weld Tabs

CONTEMPORARY DESIGN



AL-238

Height: 18-3/4"
Width: 9-3/4"
Packed 20 pcs/box
Weight 43 lbs/box
With Weld Nuts



AL-03700

Height: 23-1/8"
Width: 9-1/2"
Thickness: 3/8"
Packed 10 pcs/box
Weight 34 lbs/box
With Weld Tabs

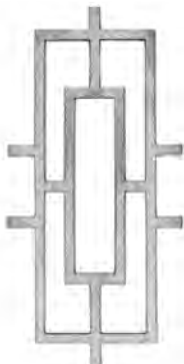

AL-03023

Height: 15-3/4"
Width: 7-5/8"
Packed 20 pcs/box
Weight 25 lbs/box
With Weld Tabs



AL-709F

Height: 13-1/2"
Width: 4-1/8"
Packed 10 pcs/box
Weight 32 lbs/box
With Weld Tabs

ALUMINUM - STORM DOOR CASTING



AL-M1

Height: 33-1/4"
 Width: 8-1/2"
 Packed 10 pcs/box
 Weight 38 lbs
 Available with screwholes:
 AL-M1SH

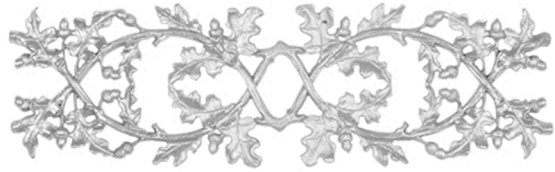

AL-M3

Height: 33-1/4"
 Width: 10"
 Packed 10 pcs/box
 Weight 50 lbs
 Available with screwholes:
 AL-M3SH



AL-M2

Height: 28-1/4"
 Width: 8"
 Packed 10 pcs/box
 Weight 35 lbs
 Available with screwholes:
 AL-M2SH

AL-M2S

Height: 27-1/4"
 Width: 8"
 Packed 10 pcs/box
 Weight 44 lbs



AL-M4

Height: 5-1/4"
 Width: 33-1/4"
 Packed 20 pcs/box
 Weight 58 lbs
 Available with screwholes:
 AL-M4SH



AL-M5

Height: 4-3/8"
 Width: 32"
 Packed 20 pcs/box
 Weight 28 lbs.
 Available with screwholes:
 AL-M5SH



AL-M6

Height: 33-1/4"
 Width: 7-3/4"
 Packed 10 pcs/box
 Weight 40 lbs
 Available with screwholes:
 AL-M6SH



AL-M7

Height: 33-1/4"
 Width: 8"
 Packed 10 pcs/box
 Weight 37 lbs
 Available with screwholes:
 AL-M7SH



AL-M8

Height: 33-1/4"
 Width: 8-1/2"
 Packed 10 pcs/box
 Weight 60 lbs
 Available with screwholes:
 AL-M8SH

ALUMINUM - STORM DOOR CASTING

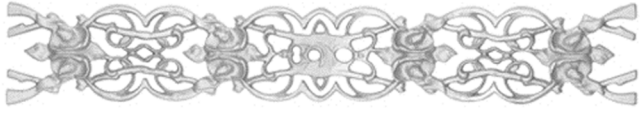

AL-M12

Height: 4-3/4"
 Width: 30-3/4"
 Packed 20 pcs/box
 Weight 53 lbs
 Available with screwholes:
 AL-M12SH



AL-M14

Height: 5"
 Width: 31-1/4"
 Packed 10 pcs/box
 Weight 33 lbs
 Available with screwholes:
 AL-M14SH



AL-M11

Height: 4"
 Width: 30-7/8"
 Double faced
 Packed 20 pcs/box
 Weight 45 lbs
 Available with screwholes:
 AL-M11SH

AL-M13

Height: 5-1/4"
 Width: 30-7/8"
 Double faced
 Packed 20 pcs/box
 Weight 45 lbs
 Available with screwholes:
 AL-M13SH



AL-442L

Height: 3-1/2"
 Width: 31-3/4"
 Packed 20 pcs/box
 Weight 33 lbs



AL-204BNB

Height: 16-3/4"
 Width: 16-3/4"
 Packed 20 pcs/box
 Weight 44 lbs/box

*Acorns backed out on reverse side



AL-MS13

Height: 5"
 Width: 10"
 Packed 40 pcs/box
 Weight 23 lbs/box



AL-MS14

Height: 5-1/8"
 Width: 9-5/8"
 Packed 40 pcs/box
 Weight 26 lbs/box

ALUMINUM - HANDRAIL BRACKETS

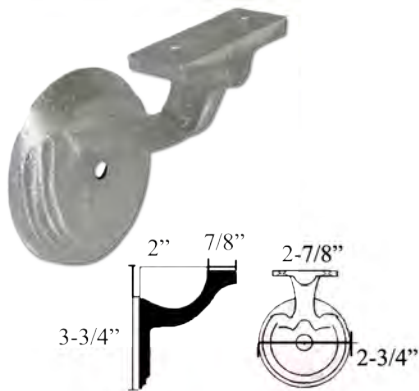

AL-BH3A

For Square Tubing
Extends 2-1/2" from wall
Packed 100 pcs/box
34 lbs/box

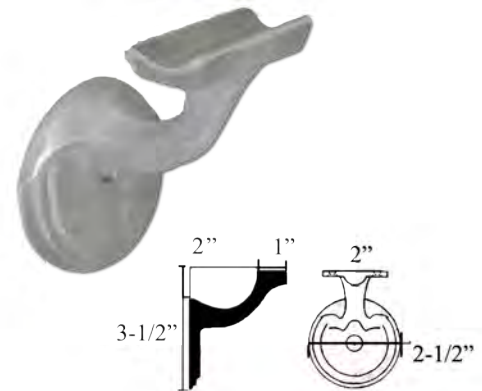

AL-BH93R

For Round Tubing
Extends 2-1/2" from wall
Packed 100 pcs/box
31 lbs/box

Aluminum has high resistance to corrosion under the majority of service conditions, as no colored salts form to stain or discolor adjacent surfaces.

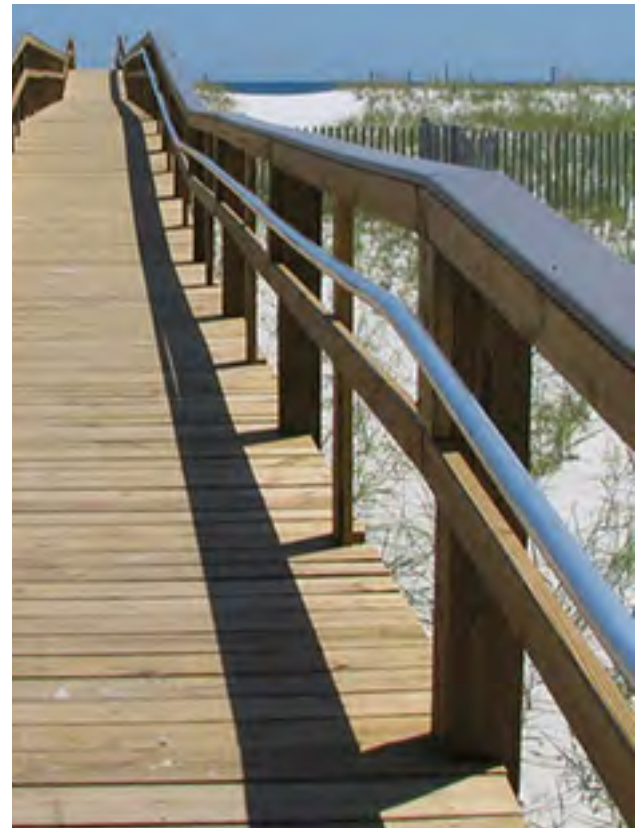

AL-BH93R shown.

ALUMINUM - SPEARS, CAPS, & SHOES



ALUMINUM POSTBALL (DIECAST)					
Item#	Fit	Ball Dia.	H	Wgt	Pk
AL-118D	2"	2"	3-3/4"	13 lbs.	20/box
AL-121D	2-1/2"	2"	4-1/4"	21 lbs.	20/box
AL-120D	3"	2-1/4"	4-1/2"	25 lbs.	20/box
AL-119D	4"	2-1/2"	5-1/4"	38 lbs.	20/box



AL-215D

Die Cast Aluminum
 Height: 4-3/8" x 2-1/4"
Available: 1/2" & 3/4"
 Packed 100 pcs/box
 13 lbs/box



AL-SHLL

For 1" Square Tubing
 One ear
 Packed 100 pcs/box
 22 lbs/box



AL-217B

Die Cast Aluminum
 Available in: 1/2", 5/8", 3/4"
 Height: 4"
 Packed 100 pcs/box
 13 lbs/box



AL-SHMM

For 1" Square Tubing
 Packed 100 pcs/box
 24 lbs/box



AL-9Z

For 1" Square Tubing
 Packed 50 pcs/box
 39 lbs/box



AL-SHRR

For 1-1/4" Square Tubing
 Packed 100 pcs/box
 26 lbs/box



A251D - ALUMINUM COLLAR (DIECAST)					
Item#	Size	Dia.	H	Wgt	Pk
AL-251-12D	1/2"	1-3/4"	1-1/2"	15 lbs.	100/box
AL-251-58D	5/8"	1-3/4"	1-3/4"	22 lbs.	100/box
AL-251-34D	3/4"	1-15/16"	2"	29 lbs.	100/box
AL-251-1D	1"	2-1/16"	2-1/2"	44 lbs.	100/box

ALUMINUM - SPEARS, CAPS, & SHOES



ALUMINUM PYRAMID CAP(DIECAST)

Item#	Fit	Wgt.	Pk
AL-142D	1-1/2"	14 lbs.	100/box
AL-143D	2"	18 lbs.	100/box
AL-147D	2-1/2"	31 lbs.	100/box
AL-144D	3"	40 lbs.	100/box
AL-145D	4"	48 lbs.	100/box



ALUMINUM COVER SHOE

Item#	Fit	B	H	W	Wgt.	Pk
AL-SH1	1"	3"	2-1/8"	3-7/8"	35 lbs.	100/box
AL-SH114	1-1/4"	3"	2"	4"	35 lbs.	100/box
AL-SH112	1-1/2"	3"	2"	4"	35 lbs.	100/box
AL-SH2	2"	4"	1-7/8"	4-5/8"	60 lbs.	100/box



ALUMINUM RINGS (TAB WELD)

Item#	Size	Weld tab	Dia.	Wgt	Pk
AL-4R	1/2"	No	3-15/16"	22 lbs.	100/box
AL-4RNT*	1/2"	Yes	3-15/16"	22 lbs.	100/box
AL-5R	1/2"	No	4-15/16"	33 lbs.	100/box
AL-5RNT*	1/2"	Yes	4-15/16"	33 lbs.	100/box

* NT - No weld tabs



ALUMINUM BALLS

Item#	Size	Wgt.	Pk
AL-B34	3/4"	30 lbs.	500/box
AL-B100	1"	31 lbs.	500/box
AL-B112	1-1/2"	39 lbs.	100/box
AL-B200	2"	26 lbs.	60/box
AL-B212	2-1/2"	40 lbs.	25/box
AL-B300	3"	54 lbs.	20/box

DUCTILE IRON

Ductile iron is low-carbon cast iron that is annealed for high tensile strength and improved flexibility. Ductile iron can be shaped through cold working such as stamping, straightening, bending, and coining operations.

DUCTILE IRON BALL



DUCTILE BALLS			
Item#	Size	Pk	Wgt.
DUC-B34	3/4"	500/box	16 lbs.
DUC-B1	1"	200/box	30 lbs.
DUC-B112	1-1/2"	100/box	47 lbs.
DUC-B2	2"	30/box	33 lbs.
DUC-B3	3"	10/box	37 lbs.
DUC-B4	4"	4/box	53 lbs.

TEXTURED DUCTILE BALLS			
Item#	Size	Pk	Wgt.
DUC-TB136	1-9/16"	100/box	46 lbs.
DUC-TB196	1-3/4"	100/box	55 lbs.

DUCTILE IRON HANDRAIL BRACKETS



DUC-BH2305

For Flat Railings
Extends 3" from Wall
Packed 50 pcs/box
Weight 56 lbs/box

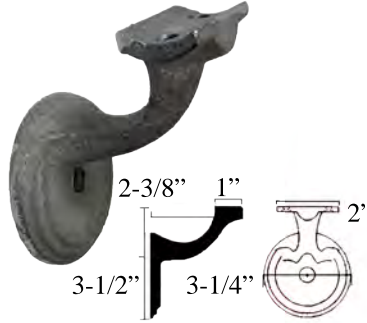

DUC-BH2306

For Pipe Railings
Extends 3" from Wall
Packed 50 pcs/box
Weight 60 lbs/box

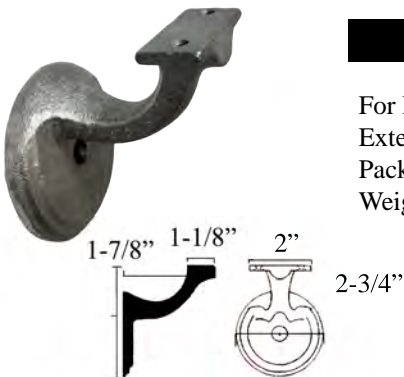

DUC-BH2381

For Flat Railings
Extends 2-1/2" from Wall
Packed 50 pcs/box
Weight 32 lbs/box

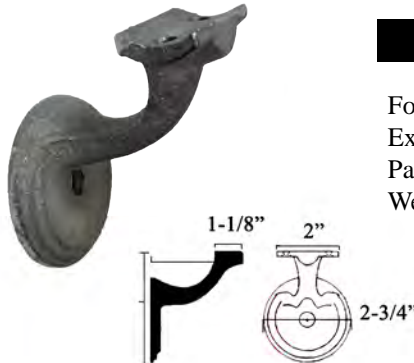

DUC-BH2382

For Pipe Railings
Extends 2-1/2" from Wall
Packed 50 pcs/box
Weight 42 lbs/box

DUCTILE IRON BALUSTER

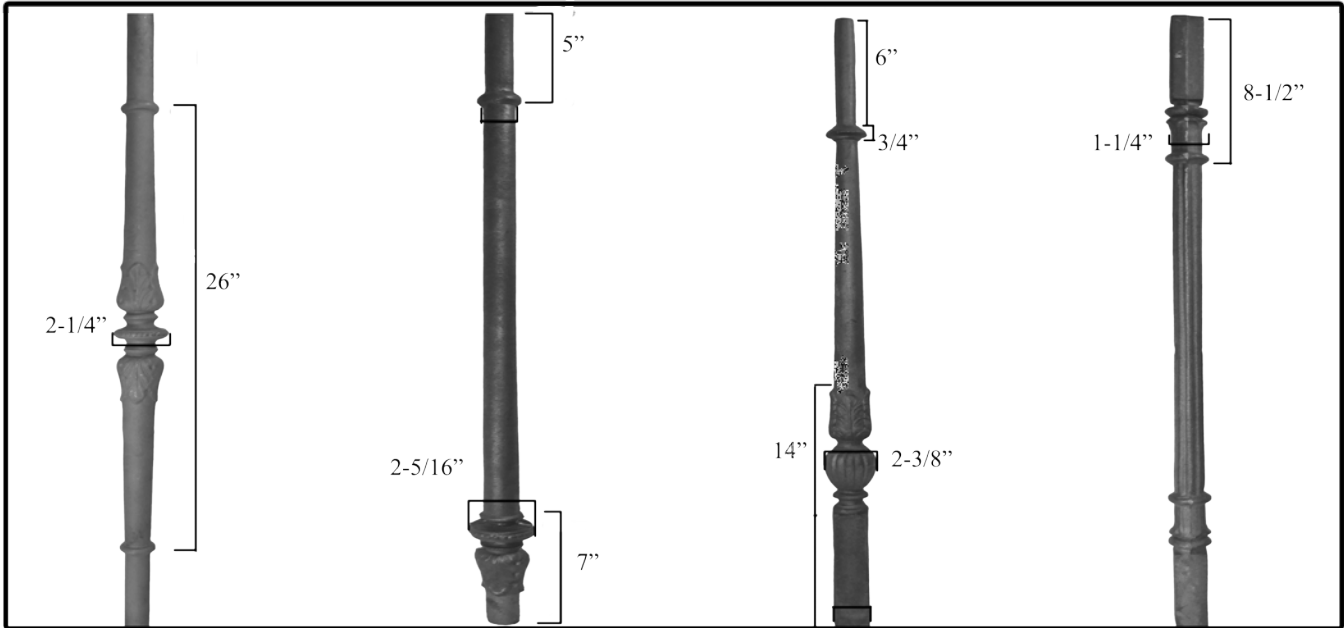

DUC-6505

Length: 36"
 Post Dia.: 1"
 Packed 4 pcs/bundle
 Weight 48 lbs/bundle

DUC-6154

Length: 36-1/4"
 Post Dia.: 1"
 Packed 4 pcs/bundle
 Weight 52 lbs/bundle

DUC-6533

Length: 36"
 Post Dia.: 1"
 Packed 4 pcs/bundle
 Weight 52 lbs/bundle

DUC-6535

Length: 36-1/4"
 Post Dia.: 1"
 Packed 4 pcs/bundle
 Weight 36 lbs/bundle

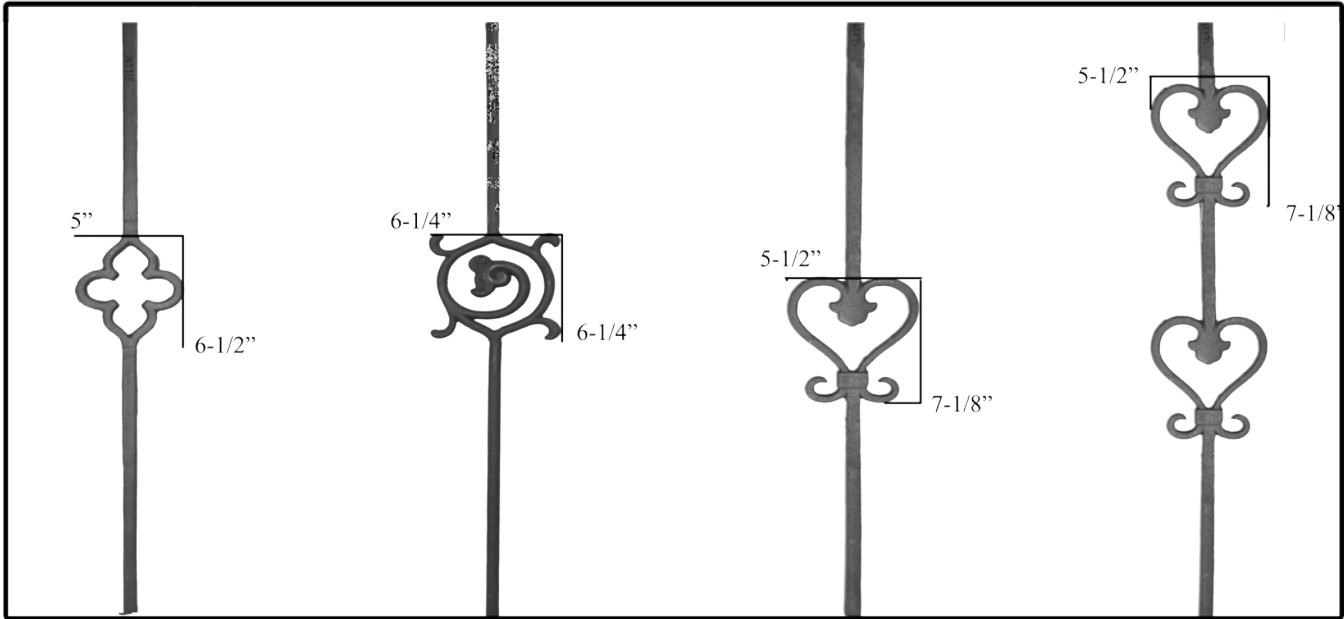

DUC-6531S

Picket: 5/8" Square
 Length: 36"
 Packed 5 pcs/bundle
 Weight 21 lbs/bundle

DUC-6532S

Picket: 5/8" Square
 Length: 36"
 Packed 5 pcs/bundle
 Weight 25 lbs/bundle

DUC-6529S

Picket: 5/8" Square
 Length: 35-1/2"
 Packed 5 pcs/bundle
 Weight 25 lbs/bundle

DUC-6529D

Picket: 5/8" Square
 Length: 36"
 Packed 5 pcs/bundle
 Weight 30 lbs/bundle

DUCTILE IRON BALUSTER

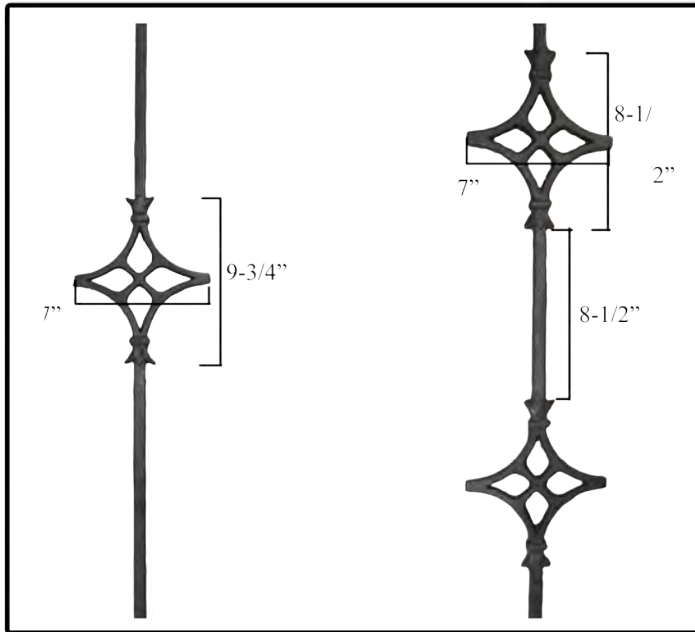

Ductile iron is a sturdier option due to higher tensile strength and improved flexibility, creating clear advantages over standard cast iron.

DUC-6528S

Length: Length: 36-1/2"
 Material: 5/8" Square
 Width: 7"
 Packed: 5 pcs/bundle
 Weight: 18 lbs/bundle

DUC-6528D

Length: 36-1/2"
 Material: 5/8" Square
 Width: 7"
 Packed: 5 pcs/bundle
 Weight: 25 lbs/bundle



DUC-9508

Length: 27"
 Width: 13-1/2"
 Packed: 5 pcs/bundle
 Weight: 55 lbs/bundle



DUC-9960

Length: 27"
 Width: 12-1/2"
 Packed: 5 pcs/bundle
 Weight: 60 lbs/bundle



DUC-9579

Length: 27"
 Width: 13-1/2"
 Packed: 5 pcs/bundle
 Weight: 66 lbs/bundle



DUC-9961

Length: 27"
 Width: 13-1/2"
 Packed: 5 pcs/bundle
 Weight: 70 lbs/bundle

DUCTILE IRON SHOES



DUCTILE IRON SHOES (ROUND)

Item#	Size	Base	Height	Wgt.	Pk
DUC-SHR2	1/2"	1-3/16"	1"	18 lbs.	100/box
DUC-SHR3	3/8"	1-3/16"	1"	18 lbs.	100/box
DUC-SHR5	5/8"	1-3/8"	1-1/8"	28 lbs.	100/box



DUCTILE IRON SHOES (ROUND)

Item#	Hole	Base	Wgt.	Pk
DUC-SHR60	1/2"	1-3/16"	18 lbs.	100/box
DUC-SHR61	5/8"	1-5/16"	29 lbs.	100/box



DUCTILE IRON SHOES (SQUARE)

Item#	Hole	Base	Wgt.	Pk
DUC-SH362	1/2"	1-1/4"	20 lbs.	100/box
DUC-SH363	5/8"	1-1/4"	22 lbs.	100/box



DUCTILE IRON SHOES (SQUARE)

Item#	Hole	Base	Height	Wgt.	Pk
DUC-SHEE	1/2"	1-1/4"	7/8"	24 lbs.	150/box
DUC-SHGG	5/8"	1-1/4"	7/8"	24 lbs.	150/box
DUC-SH398	3/4"	1-7/16"	7/8"	19 lbs.	100/box
DUC-SHMM	1"	1-3/4"	1-1/8"	33 lbs.	100/box

DUCTILE IRON RAILENDS



DUCTILE CHANNEL RAILEND

Item#	Fit	Width	Length	Wgt	Pk
DUC-RE100CC	1-3/4"	4-1/2"	4-1/2"	25 lbs.	50/box
DUC-RE125CC	2-1/4"	4-5/8"	4-5/8"	22 lbs.	40/box



DUCTILE CHANNEL RAILEND

Item#	Fit	Width	Length	Wgt	Pk
DUC-RE4429C	1-3/4"	6"	6"	29 lbs.	30/box
DUC-RE4441C	2-1/4"	6-1/8"	6-1/8"	30 lbs.	20/box



DUCTILE TERMINAL RAILEND

Item#	Fit	Width	Length	Wgt	Pk
DUC-RE4429E	1-3/4"	3-3/4"	2-1/4"	29 lbs.	30/box
DUC-RE4441E	2-1/4"	4-3/4"	3-1/8"	33 lbs.	25/box



DUCTILE RAILEND CAP

Item#	Fit	Width	Length	Wgt	Pk
DUC-RE4429N	1-3/4"	2-1/2"	1-3/4"	28 lbs.	80/box
DUC-RE4441N	2-1/4"	2-1/2"	2-1/4"	23 lbs.	50/box



DUCTILE LAMBS TONGUE

Item#	Fit	Width	Length	Wgt	Pk
DUC-RE4429B	1-3/4"	4"	5"	28 lbs.	20/box



DUCTILE LAMBS TONGUE

Item#	Fit	Width	Length	Wgt	Pk
DUC-RE4429S	1-3/4"	5"	4-3/4"	28 lbs.	20/box
DUC-RE4441S	2-1/4"	5"	4-3/4"	52 lbs.	20/box

DUCTILE IRON RAILENDS



DUCTILE CORNER PIECE

Item#	Fit	Width	Length	Wgt	Pk
DUC-RE4429L	1-3/4"	3-7/8"	3-7/8"	38 lbs.	50/box



DUCTILE CENTER PIECE

Item#	Fit	Width	Length	Wgt	Pk
DUC-RE4429T	1-3/4"	5-1/4"	2-1/4"	30 lbs.	40/box



DUCTILE MOLDED VOLUTE

Item#	Fit	Width	Length	Wgt	Pk
DUC-RE4429V	1-3/4"	4-5/8"	1-3/4"	26 lbs.	25/box
DUC-RE4441V	2-1/4"	4-5/8"	2-1/4"	32 lbs.	20/box



DUC-4429V Railend shown, mounted on HD-BH300.

HARDWARE - HINGES

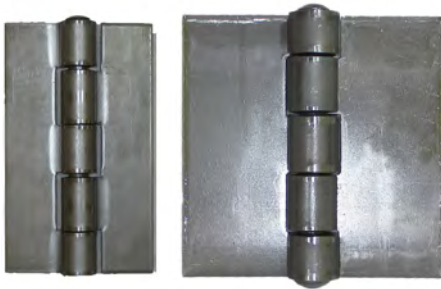

Shown: 2x2" Hinge & 3-1/2"x2-1/4" Hinge

WELDABLE BUTT HINGE (TIGHT PIN/ BRIGHT STEEL)

Item#	Size	Gauge	PCS./Bx	Swaged	Wgt.
HD-HSD22	2"x2"	14	400	Yes	53 lbs.
HD-HSD33	3"x3"	13	200	Yes	59 lbs.
HD-HSD3134	3"x1-3/4"	12	200	Yes	64 lbs.
HD-HSD35225	3-1/2"x2-1/4"	12	200	Yes	64 lbs.
HD-HSD3535	3-1/2"x3-1/2"	12	100	Yes	45 lbs.
HD-HSD44	4"x4"	12	100	Yes	58 lbs.



Shown: HB5NSNP/HB5

BARREL HINGE

Item	Size	Barrel Dia.	Pin	Bearing	Plate	PCS./Bx	Wgt.
HD-HB2	2"	5/8"	Steel	No	No	400	62 lbs.
HD-HB3	3"	3/4"	Steel	No	No	200	74 lbs.
HD-HB5*	5"	1"	S/S	Ball	Yes	40	54 lbs.
HD-HB5NS	5"	1"	Steel	Ball	Yes	40	51 lbs.
HD-HB5NSNP	5"	1"	Steel	Ball	No	40	46 lbs.
HD-HB7*	7"	1-1/4"	S/S	Ball	Yes	16	51 lbs.
HD-HB7NS	7"	1-1/4"	Steel	Ball	Yes	16	51 lbs.
HD-HB7NSNP	7"	1-1/4"	Steel	Ball	No	16	46 lbs.
HD-HB9*	9"	2"	S/S	Ball	Yes	6	62 lbs.
HD-HB9NP*	9"	2"	S/S	Ball	No	8	63 lbs.

*S/S denotes Stainless Steel Pin



Shown: Heavy Duty Hinge

HEAVY DUTY BUTT HINGE (NON-SWAGED)

Item#	Size	Gauge	PCS./Bx	Swaged	Wgt.
HD-HHD33	3"x3"	0.125"	100	No	44 lbs.
HD-HHD44	4"x4"	0.178"	50	No	55 lbs.
HD-HHD55	5"x5"	0.198"	40	No	66 lbs.
HD-HHD66	6"x6"	0.198"	20	No	53 lbs.

All Heavy Duty Hinges are Non-Swaged

HARDWARE - HINGES



DECORATIVE H-HINGE W/BRASS BUSHINGS

Item#	Finish	Size	Hole Dia.	PCS./Bx	Wgt.
HD-HHB	P.C. Black	2-5/8"X7"	1/4"	100	60 lbs.
HD-HHSP	Smooth	2-5/8"X7"	1/4"	100	60 lbs.
HD-HHW	P.C. White	2-5/8"X7"	1/4"	100	60 lbs.
HD-HHZ	Zinc Plated	2-5/8"X7"	1/4"	100	60 lbs.
HD-HHP	Plain	2-5/8"X7"	1/4"	100	60 lbs.

H-Hinges feature weldable steel and tight pin construction



ADJUSTABLE BARREL HINGE

Item#	Size	J-Bolt	Wgt.	PCS./box
HD-HB5ADJ	5/8"	4-3/8"	53 lbs.	40/box
HD-HB7ADJ	3/4"	6-3/4"	52 lbs.	16/box



SINGLE ACTION SPRING HINGE

Item#	Finish	Size	Pin	Wgt.	PCS./box
HD-HSP312B	Black	3-1/2"x3-1/2"	3/16"	39 lbs.	50/box
HD-HSP312M	Mill	3-1/2"x3-1/2"	3/16"	39 lbs.	50/box
HD-HSP4B	Black	4"x4"	3/8"	46 lbs.	50/box
HD-HSP4M	Mill	4"x4"	3/8"	46 lbs.	50/box
HD-HSP412M	Mill	4-1/2"X4-1/2"	3/8"	35 lbs.	30/box

HSP412 not available in Black



RECTANGULAR BLOCK HINGE

Item#	W	L	H	Wgt.	PCS./box
HD-HB5REC	1"	1-1/4"	5"	70 lbs.	40/box
HD-HB7REC	1-3/4"	1-1/4"	7"	36 lbs.	16/box

HARDWARE - LOCKSETS

MORTISE LOCKSET w/ LEVER

Packed 12 pcs/box 60 lbs./box

- Solid Brass Decorative Trim
- Solid Brass Decorative Lever w/Rosette
- Mortise Lock w/ 1" Deadbolt
- Double solid Brass Cylinders
- Kwikset Keyway **Keyed Alike 6**
- Night Latch

LCK-MLH113 (Polished Brass)

LCK-MLH115 (Antique Brass)

LCK-MLH1126D (Satin Chrome)

LCK-MLH111P (Oil Rubbed Bronze)



MORTISE LOCKSET w/ KNOB

Packed 12 pcs/box 53 lbs./box

- Solid Brass Decorative Trim
- Brass Decorative Round Knob w/Rosette
- Mortise Lock w/ 1" Deadbolt
- Double solid Brass Cylinders
- Kwikset Keyway **Keyed Alike 6**
- Night Latch

LCK-MLK403 (Polished Brass)

LCK-MLK405 (Antique Brass)

LCK-MLK4026D (Satin Chrome)

LCK-MLK411P (Oil Rubbed Bronze)



MORTISE LOCKSET w/ LEVER

Packed 12 pcs/box 61 lbs./box

- Solid Brass Decorative Trim
- Modern Lever Handle
- Mortise Lock w/ 1" Deadbolt
- Double solid Brass Cylinders
- Kwikset Keyway **Keyed Alike 6**
- Night Latch

LCK-MLH223 (Polished Brass)

LCK-MLH235 (Antique Brass)



HARDWARE - LOCKSETS

MORTISE LOCKSET w/KNOB

Packed 12 pcs/box

44 lbs/ box

- Solid Brass Round Knob w/ Rosette
- Mortise lock with 1" Deadbolt
- Night latch
- Kwikset Keyway **KA-6**

LCK-MLK223 - Polished Brass

LCK-MLK225 - Antique Brass

LCK-MLK2226D - Satin Chrome

LCK-MLK211P - Oil rubbed bronze

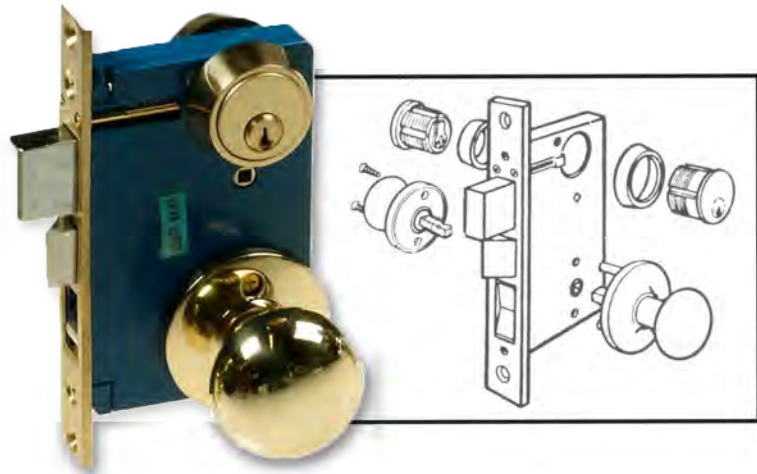

ACCESSORIES AND PARTS

Items below available in different finishes

LPT-LH9370	Lever handle - Left or Right facing
LPT-MK9830	Mushroom knob
LPT-TCY9385	Thumbturn cylinder
LPT-CY9380	Keyed cylinder- available with Kwikset OR Schlage keyways
LPT-K9242	Replacement knob set
LPT-MLBTT	Brass thumbturn
LPT-BPH9355	Brass Plate- L: 2-3/4" x W: 2"
LPT-MLLB9300	Lockbody Acc. (Right or Left)
LPT-RCY9252	Replacement exterior cylinder ring
LPT-BPH9355	Trim plate

Knobs, trim plates, lock bodies, lever handles, and thumbturns are available in several finishes and can be ordered separately.

LCK-SLH556 SLIMLINE MORTISE LOCKSET

- Improved true 1" deadbolt and latch bolt that retracts with key operation and handle.
- Solid brass rekeyable Kwikset cylinders.
- Available with double-keyed cylinders and single cylinder thumb-turns and four finishes: polished brass, satin chrome, oil-rubbed bronze, and antique brass.
- Designed to interchange with the same punched and machined tubing as our original SLH-516 lock.
- Much easier to install and uses the CEL-LG-S9 (9.5" lockguard)

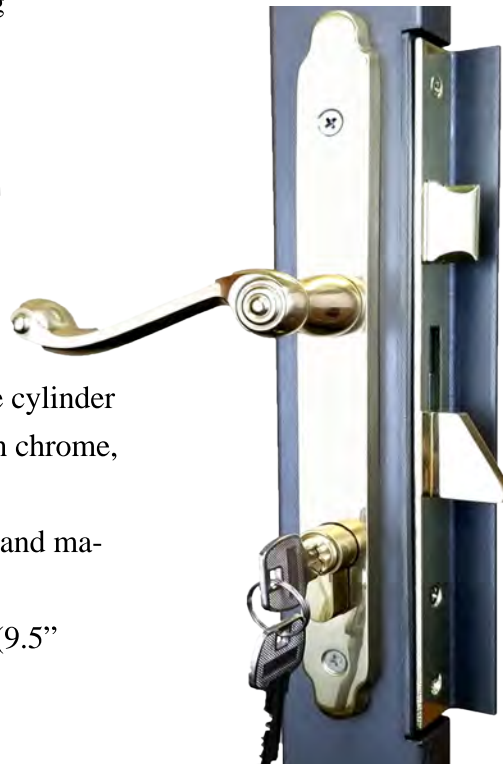

HARDWARE - LOCKSETS

SLIM-LINE MORTISE LOCKSET

Packed 12 pcs/box
42 lbs/ box

- Solid Brass Decorative Lever w/ Trim
- Mortise lock with 1" Deadbolt
- Double Solid Brass Rekeyable Cylinders
- Kwikset Keyway **KA-12**

1" DEADBOLT

LCK-SLH5563 - Polished brass

LCK-SLH5565 - Antique brass

LCK-SLH55626D - Satin chrome

LCK-SLH55610B - Oil rubbed bronze

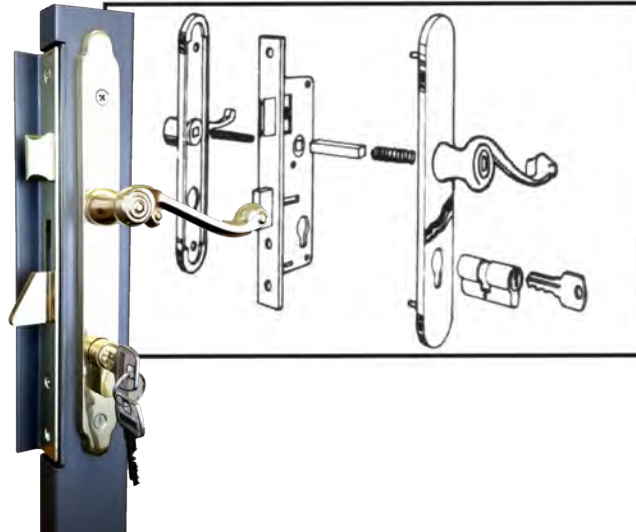

SLIM-LINE MORTISE LOCKSET

Packed 24 pcs/box
45 lbs/box

- Solid Brass Trim w/ Die Cast Handle
- Mortise lock with 5/8" Deadbolt
- Double Solid Brass Rekeyable Cylinders
- Kwikset Keyway **KA-12**

LPT-SLB9600 - Lockbody available

LCK-SLH2003 - Polished Brass

LCK-SLH20026D - Satin Chrome

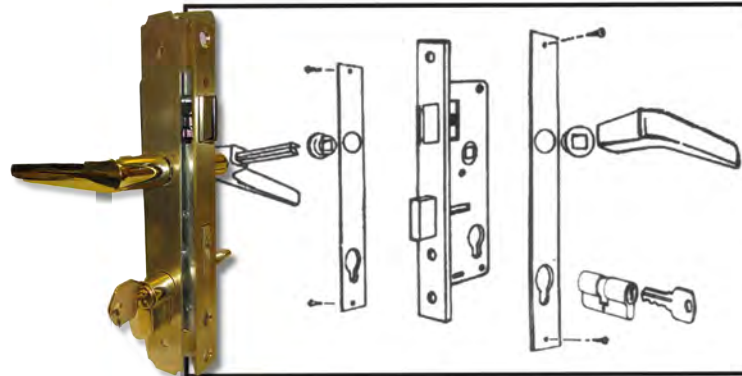

SLIM-LINE MORTISE LOCKSET

Packed 24 pcs/box
69 lbs/box

- Solid Brass Trim w/ Handle
- Mortise lock with 5/8" Deadbolt
- Double Solid Brass Rekeyable Cylinders
- Kwikset Keyway **KA-12**

LCK-SLH536200 - Polished Brass

LCK-SLH53626D - Satin Chrome

LCK-SLH53610B - Oil Rubbed Bronze

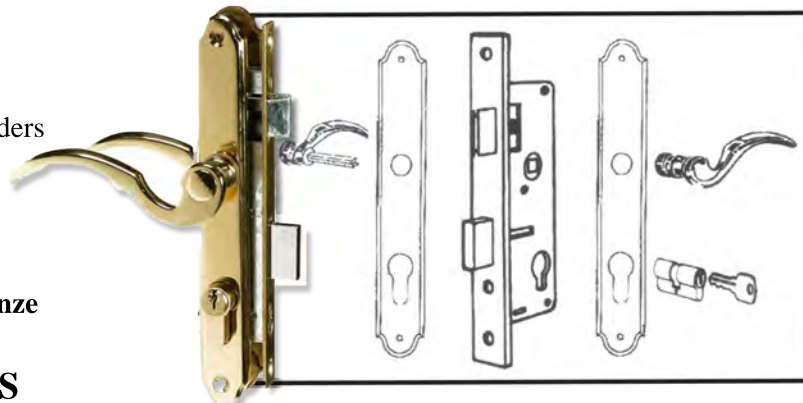

ACCESSORIES AND PARTS

- LPT-SCY9680** Double Cylinder
LPT-SDT9635 Dummy Trim and Lever
LPT-TSCY9685 Cylinder and Thumbturn

Lever trim set, mortise lock body, cylinders, and key blanks can be ordered seperately.

HARDWARE - LOCKSETS

EZSET LEVER HANDLES

Packed 20 pcs/box

31 lbs/box

2-3/8" Backset

LCK-EZLHK3 - Polished Brass

LCK-EZLHK5 - Antique Brass

LCK-EZLHK32D - Satin Chrome



LCK-EZLHK5 shown.

EZSET KEYED ENTRY

Packed 20 pcs/box

36 lbs/box

2-3/8" Backset

LCK-EZLHK363 - Polished Brass

LCK-EZLHK365 - Antique Brass



LCK-EZLHM3 shown.

EZSET LEVER DOUBLE CYLINDER COMBINATIONS

Packed 10 pcs/box

31 lbs/box

LCK-EZDTLK-363 - Polished Brass
(EZLHK363/T6333)

LCK-EZDTLK-365 - Antique Brass
(EZLHK365/T63335)

LCK-EZDTLK-3632D - Satin Chrome
(EZLHK3632D/T63332D)



LCK-EZDTLK-363 shown.

CEL LEVER HANDLES

Packed 24 pcs/box

29 lbs/box

2-3/8" Backset

LCK-LHM3 - Polished Brass

LCK-LHM5 - Antique Brass

CEL KEYED LEVER ENTRY

Packed 24 pcs/box

36 lbs/box

2-3/8" Backset

LCK-LHM363 - Polished Brass

LCK-LHM365 - Antique Brass

LCK-KK9301 "EZ" Set Keying Kit

LPT-GL3 - Polished Brass

LPT-GL5 - Antique Brass

LPT-GL26D - Satin Chrome

SPRING LATCH ONT V

2-3/8" Backset

Packed 12 pcs/box

4 lbs/box



HARDWARE - LOCKSETS

EZSET SINGLE CYLINDER DEADBOLT

Packed 20 pcs/box
32 lbs/box
KA-10



LCK-EZS1113 - Polished Brass
LCK-EZS1115 - Antique Brass
LCK-EZS11132D - Satin Chrome
LCK-EZS11110B - Oil Rubbed Bronze

EZSET DOUBLE CYLINDER DEAD- BOLT

Packed 20 pcs/box
32 lbs/box
KA-10



LCK-EZD2113 - Polished Brass
LCK-EZD2115 - Antique Brass
LCK-EZD21132D - Satin Chrome
LCK-EZD21110B - Oil Rubbed Bronze



Passage

20 pcs/box
26 lbs./box

LCK-EZT6113 - Polished brass
LCK-EZT6115 - Antique Brass
LCK-EZT61132D - Satin Chrome

Keyed Entry

20 pcs/box
29 lbs/box
KA-10

LCK-EZT6333 - Polished Brass
LCK-EZT6335 - Antique Brass
LCK-EZT63332D - Satin Chrome

Single Cylinder Storeroom-

20 pcs/box
29 lbs/box
KA-10 (only keyed on one side)

LCK-EZT6453 - Polished Brass
LCK-EZT64532D - Satin Chrome



EZ-DT shown in Antique Brass finish.

LCK-EZST3 Single Cylinder Combo
(S1113/T6333) Polished Brass
LCK-EZST5 Single Cylinder Combo
(S1115/T6335) Antique Brass
LCK-EZST32D Single Cylinder Combo
Satin Chrome Finish
LCK-EZST10B Single Cylinder Combo
Oil Rubbed Bronze

EZ-SET Combination locksets are packed 10 sets/box and keyed alike. 30 lbs per box.

LCK-EZDT3 Double Cylinder Combo
(D2113/T6333) Polished Brass
EZ-DT5 Double Cylinder Combo
(D2115/T6335) Antique Brass
EZ-DT32D Double Cylinder Combo
Satin Chrome Finish
EZ-DT10B Double Cylinder Combo
Oil Rubbed Bronze

HARDWARE - LOCKSETS

CEL DOUBLE/SINGLE CYLINDER DOOR LOCKS

DC- DOUBLE CYLINDER/ SC- SINGLE CYLINDER

Item#	Finish	Screws	KA	Wgt.	PCS./box
LCK-DC3	PB	Concealed	12	37 lbs.	24/box
LCK-DC5	AB	Concealed	12	37 lbs.	24/box
LCK-DC32D	SC	Concealed	12	37 lbs.	24/box
LCK-SC3	PB		12	26 lbs.	24/box
LCK-SC5	AB		12	26 lbs.	24/box
LCK-SC32D	SC		12	26 lbs.	24/box



Shown: LCK-DC3- Available with thumbturn

LCK-SC / LCK-DC

CEL LOCK CYLINDER W/SPRING LATCH

Latch Springs back and Locks Automatically when Key is removed from Cylinder on either side. Provides convenience and security for wood and steel gates.

2-3/8" Backset
Packed 24/box
31 lbs/box

Single Cylinder - Also available w/ Schlage keyway

LCK-SC3 - Polished Brass
LCK-SC5 - Antique Brass
LCK-SC32D - Satin Chrome

Double Cylinder

LCK-DC3L - Polished Brass
LCK-DC5L - Antique Brass



Shown: LCK-DC3L- Available with thumbturn

LCK-LSIPBD / LSIPBS

SNAP-IN DEAD BOLT LOCK

LCK-LSIPD- Double Cylinder Keyed both sides
LCK-LSIPBS- Single Cylinder w/Thumbturn

Keyed Alike in 12
Packed 24 pcs/box
40 lbs/box

For use in 1" x 3" Steel Tubing
Concealed mounting screw
Fits Flush into Tubing
Lock Box Optional



HARDWARE - LOCKSETS

HOOKLOCKS

1-1/8" Backset
Black P/C Lockbox
Kwikset Keyway
Inc. 2 Keys

LCK-18200 - Double Cylinder

LCK-18200S - Single Cylinder
Available in Right/Left

LCK-18500 - Straight Bolt

LCK-45100 - Spring Latch
Available in Right/Left

Packed 12 pcs/box
38 lbs/box

18200



With Double Cylinder

18500



With Swing Up
Straight Bolt

45100

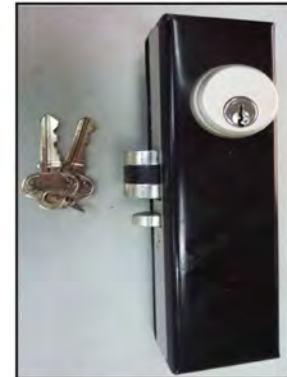

With Reversible
Spring Latch

DIGITAL PUSH BUTTON DOOR LOCK

LCK-NK4000LXL (Left)

LCK-NK4000LXR (Right)

Satin Chrome Finish
Lockbox width: 1-1/4"
Sold each
6 lbs/each

- All-mechanical actions
- Over 5,000 possible code combinations
- Codes can be easily changed
- Can be used for left or right-handed doors
- Over 100,000 operations tested



HARDWARE - LOCK BOXES

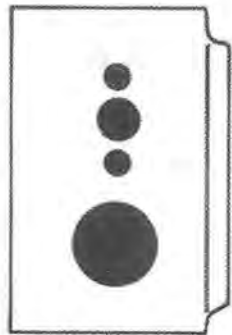

15-605L - Left



15-605R - Right

MORTISE LOCKBOX (14 GAUGE)

Item#	Size	Hinge Side	Pk	Wgt.
LCK-15-605L	1"x4"x7-1/4"	Left	20	40 lbs.
LCK-15-605R	1"x4"x7-1/4"	Right	20	40 lbs.

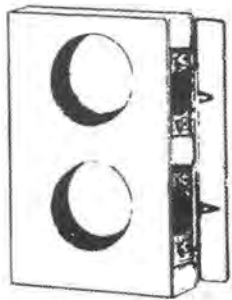

Shown: 15-276



Shown: 15-176

LOCKBOX W/ FLAT BOLT GUARD

Item#	Backset	Width	Hole Dia.	Pk	Wgt.
LCK-15-176	2-3/8"	1-1/4"	2-1/8"	40	40 lbs.
LCK-15-276	2-3/8"	1-1/4"	Dbl 2-1/8"	20	40 lbs.



Shown: 15-250R

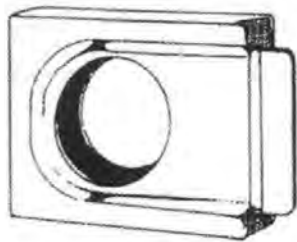

Shown: 15-150R

LOCKBOX W/ STRAIGHT BOLT GUARD

Item#	Backset	Width	Hole Dia.	Pk	Wgt.
LCK-15-150S	2-3/8"	1"	2-1/8"	40	37 lbs.
LCK-15-250S	2-3/8"	1"	Dbl 2-1/8"	20	40 lbs.

LOCKBOX W/ BENT BOLT GUARD

Item#	Backset	Width	Hole Dia.	Pk	Wgt.
LCK-15-150R	2-3/8"	1"	2-1/8"	40	37 lbs.
LCK-15-250R	2-3/8"	1"	Dbl 2-1/8"	20	40 lbs.

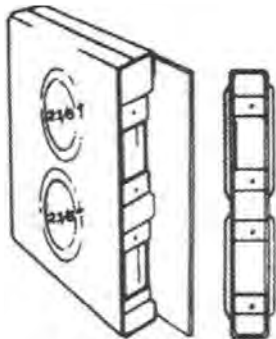

Shown: 15-225

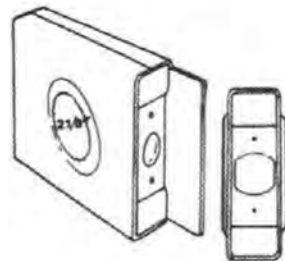

Shown: 15-125

BUBBLE LOCKBOX W/ BOLT GUARD

Item#	Backset	Width	Hole Dia.	Pk	Wgt.
LCK-15-125	2-3/8"	1-1/4"	2-1/8"	40	40 lbs.
LCK-15-225	2-3/8"	1-1/4"	Dbl 2-1/8"	20	40 lbs.
LCK-15-225NG*	2-3/8"	1-1/4"	Dbl 2-1/8"	20	38 lbs.

* NG - No Bolt Guard

HARDWARE - LOCK BOXES

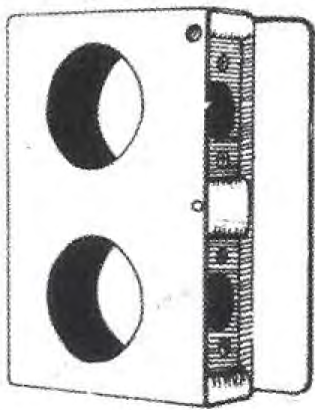

Shown: 13-205

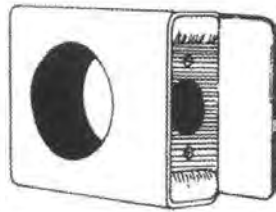

Shown: 13-105

LOCK BOX (W/BOLT GUARD)

Item	Backset	Hole	W	Pk	Wgt.
LCK-13-105	2-3/8"	Sgl 2-1/8"	1-5/8"	40	40 lbs.
LCK-13-205	2-3/8"	Dbl 2-1/8"	1-5/8"	20	35 lbs.
LCK-13-115	2-3/8"	Sgl 2-1/8"	1-1/2"	40	40 lbs.
LCK-13-215	2-3/8"	Dbl 2-1/8"	1-1/2"	20	35 lbs.
LCK-13-134	2-3/4"	Sgl 2-1/8"	1-1/2"	40	40 lbs.
LCK-A13-115	2-3/8"	Sgl 2-1/8"	1-1/2"	40	40 lbs.
LCK-A13-215	2-3/8"	Dbl 2-1/8"	1-1/2"	20	35 lbs.
LCK-13-140	2-3/8"	Sgl 2-1/8"	2"	40	40 lbs.
LCK-13-240	2-3/8"	Dbl 2-1/8"	2"	20	40 lbs.

A - Aluminum

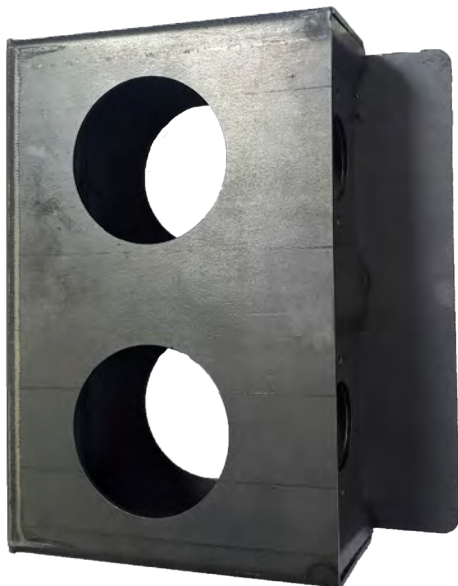

Shown: 13-240 (2" wide steel lockbox)

While most hardware will adjust anywhere between 1-3/4" to 2" thick, it's always a good idea to measure the thickness of your door before ordering hardware.

HARDWARE - GATE



RUBBER ROLLERS - WELDED

Item	Size	Pk	Wgt (lbs.)
HD-RR3	3"	40	44
HD-RR6	6"	20	36
HD-RR12	12"	10	42
HD-RR3D	3"	40	47
HD-RR6D	6"	20	39

*"D" denotes disassemblable

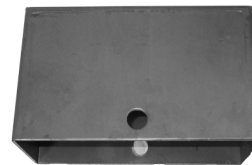

V-GROOVE WHEELBOXES

Item	L	W	H	Hole	Pk	Wgt
HD-BVG3	3-3/4"	2-1/8"	2-5/8"	1/2"	50	50
HD-BVG4	4-1/2"	2-1/4"	3-1/2"	1/2"	24	35
HD-BVG6	7"	2-3/4"	4-1/16"	3/4"	20	54
HD-BVGP6	7"	2-1/4"	4"	9/16"	20	50

Constructed with 10 gauge steel



HD PLASTIC ROLLERS - NON MARRING

Item	Size	Pk	Wgt (lbs.)
HD-NR3	3"	40	44
HD-NR6	6"	20	36
HD-NR12	12"	10	42



GATE SPRING ROLLER

Item	HD-WSLG
Wheel Size	3" Swivel
Capacity (lbs.)	100 lbs.
Finish	Mill
Height (in.)	16-3/4"
Per/box	10
Weight(lbs.)	32



Locking



Heavy Duty



Standard



ADJUSTABLE DOOR SPRING W/SCREWS

Item	Length	Pk	Wgt
HD-DS9	9"	80	53 lbs.
HD-DS12	12"	50	59 lbs.

CANE BOLT

Item	Length	Bolt Dia.	Finish	Pk	Wgt
HD-BC1212	12" Cane Bolt	1/2"	Zinc	50	50 lbs.
HD-BC1812	18" Cane Bolt	1/2"	Zinc	40	54 lbs.
HD-BC2458	24" Cane Bolt	5/8"	Zinc	30	61 lbs.
HD-BCL12	22" Locking Cane Bolt	1/2"	Mill	25	45 lbs.
HD-BXC20	20" Heavy Duty Cane Bolt	3/4"	Black	10	52 lbs.

Cane bolt bracket available for individual purchase: HD-BCBRK

HARDWARE - GATE

GATE HANGER BOLT (GALVANIZED)

Item	Size	Pcs./ Bx	Weight (Box)
HD-BGHJZ	1/2" x 4-1/2" (Zinc Plated)	150	56 lbs.
HD-BGHJ (Galvanized)	1/2" x 4-1/2"	150	57 lbs.
HD-BGHJ58	5/8" x 4-1/2"	100	35 lbs.
HD-BGHJ34	3/4" x 7"	50	29 lbs.



Fancy Gate Latch



No Hole Gate Latch



Universal Gate Latch



XL Gate Latch

GATE LATCHES

Item	Desc.	Bar	Base	Plating	Pcs./Bx	Weight (Box)
HD-LFG	Fancy Gate Latch	9"	N/A	Mill	50	64 lbs.
HD-LNHG	No Hole Gate Latch	3-7/8"	1"	Mill	100	37.5 lbs.
HD-LUGGZ	Universal Gate Latch (w/Screw Holes)	5"	1-3/8"	Zinc	100	41 lbs.
HD-LUGGBXL	Extra Large Gate Latch	12"	2-1/8"	Black	30	58.5 lbs.

Latch bar available for individual purchase

SLIDE BOLT (WELDABLE)

Item	Size (in.)	Bolt Dia. (in.)	Pk	Wgt(lbs.)
HD-BHDS12	5-1/2"	1/2"	60	41 lbs.
HD-BXHDS34	9-1/2"	3/4"	20	52 lbs.



1/2" Slidebolt



3/4" Slidebolt

HARDWARE - ROLLING



Cast Iron



Nylon



Steel

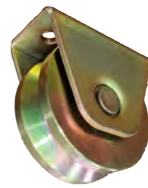

Steel 3" w/ Bracket

Two sets of wheels are recommended for spanning lengths of 15 feet.

V-GROOVE CAST IRON / STEEL WHEELS

Item#	Material	Size (in.)	Width	Axle Dia. (in.)	Cap. per Pair (lbs.)	Finish	Pk	Wgt
HD-WVG3	Cast Iron	3"	1-1/2"	3/8"	600 lbs.	Black	30/box	49 lbs
HD-WVG4	Cast Iron	4"	1-1/2"	1/2"	1,000 lbs.	Black	20/box	57 lbs
HD-WVGB4*	Cast Iron	4"	1-1/2"	1/2"	1,000 lbs.	Black	20/box	57 lbs
HD-WVG6	Cast Iron	6"	2"	1/2"	1,200 lbs.	Black	10/box	70 lbs
HD-WVGSP3 w/ Bracket	Steel	3"	1-3/4"	3/8"	600 lbs.	Galv. Gold	24/box	69 lbs
HD-WVGSP4	Steel	4"	1-3/4"	1/2"	1,200 lbs.	Galv. Gold	8/box	40 lbs
HD-WVGSP6	Steel	6"	1-3/4"	1/2"	2,000 lbs.	Chrome	4/box	46 lbs
HD-WVG4N	Nylon	4"	1-3/4"	5/8"	250 lbs.	Black	48/box	68 lbs

*HD-WVGB4 utilizes sealed bearings



2-Wheel Overhead Track Wheels



4-Wheel Overhead Track Wheels



HD Overhead Track Wheels

OVERHEAD TRACK WHEEL

Item#	Wheels	Dia.	Bolt Length	O.W.	I.W.	Wgt.	Pk
HD-OTC	2-Wheel OT	1-5/8"	4-1/4"	1-5/8"	15/16"	47 lbs.	60/box
HD-OTC4	4-Wheel OT	2-1/8"	4-7/8"	1-1/2"	15/16"	67 lbs.	60/box
HD-OTCH	4-Wheel HD OT	1-7/8"	6-1/4"	1-1/2"	1"	40 lbs.	20/box

HARDWARE - DOOR



13-MS-CS mail slot and LA-190S casting depicted.

LETTER SLOT SET

HD-10LSCS
Letter Slot Complete Set

Available in: Polished Brass,
Antique Brass, Satin Chrome,
and Oil-rubbed Bronze

Measures 10" x 3-1/8"
Packed 20 pcs/box
24 lbs/box

LETTER SLOT - FRONT

HD-10LSF
Letter Slot Front Only

Available in: Polished Brass,
Antique Brass, Satin Chrome,
and Oil-rubbed Bronze

Measures 10" x 3-1/8"
Packed 40 pcs/box
28 lbs/box

MAGAZINE SLOT SET

HD-13MSCS
Magazine Slot Complete Set

Available in: Polished Brass,
Antique Brass, Satin Chrome,
and Oil-rubbed Bronze

Measures 13" x 3-5/8"
Packed 20 pcs/box
40 lbs/box

MAGAZINE SLOT - FRONT

HD-13MSF
Magazine Slot Front Only

Available in: Polished Brass,
Antique Brass, Satin Chrome, and
Oil-rubbed Bronze

Measures 13-1/8" x 3-5/8"
Packed 40 pcs/box
44 lbs/box

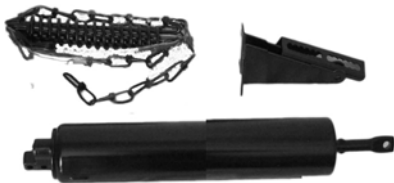

DOOR CLOSER SET

HD-VDC107 (Black)
HD-VDC107W (White)
Door Closer w/Storm Chain (1601)
Tube Dia.: 1-1/2"
Packed 20 pcs/box
35 lbs/box

HD-DC1107 (Black)
HD-DC1107W (White)
Door Closer Only
Packed 20 pcs/box
30 lbs/box



HD DOOR CLOSER

HD-DC1108 (Black)
Heavy Duty Door Closer
Tube Dia.: 1-1/2"
W/ Torsion Bar available
Packed 20 pcs/box
35 lbs/box



DOOR CHAIN

HD-DC1601B (Black)
HD-DC1601 (Zinc)
Measures 13" x 3-5/8"
Packed 120 pcs/box
46 lbs/box

HEAVY DUTY GATE CLOSER

HD-GC2000

- Easy Installation, compact and durable.
- Over 100,000 operations tested.
- 90 degree hold open function.
- Two-speed closing
- Suitable for indoor or outdoor installation
- Designed specifically for use on Metal Gates, can also be used on wooden doors.
- Weight limit per closer up to 120 lbs.

Packed 12 pc/box
Weight: 29 lbs/bx

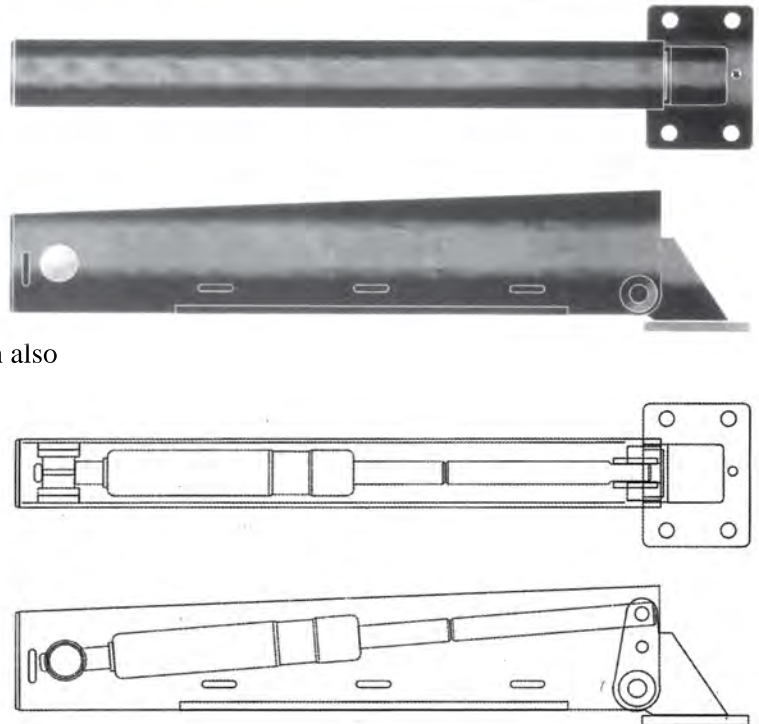

HD-GC3000

- Self-closing hydraulic-action gate closer.
- Closes up to 125 lbs gently and smoothly.
- Adjustable hydraulic action provides reliable and ample closing force.
- Rugged design can be used indoors or outdoors.
- Quality hydraulic cylinder guarantees exceptional reliability.

Packed 8pc/box
Weight: 42 lbs/box



HARDWARE - WINDOW

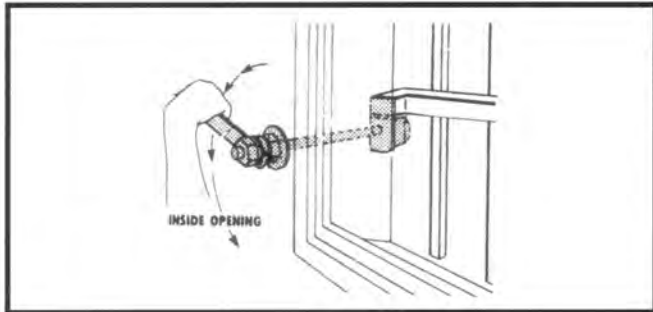

WINDOW GUARD FIRE RELEASE

HD-WGFR7R (7")
 HD-WGFR9R (9")
 HD-WGFR11R (11")

- Lever operated.
- 1/2" Hole through wall required for installation.
- Complete with "D" shaft/hole handle.
- Spring loaded. (Spring retained in cylinder head)
- Easily adjustable for wall thicknesses

Packed 80 pcs/box

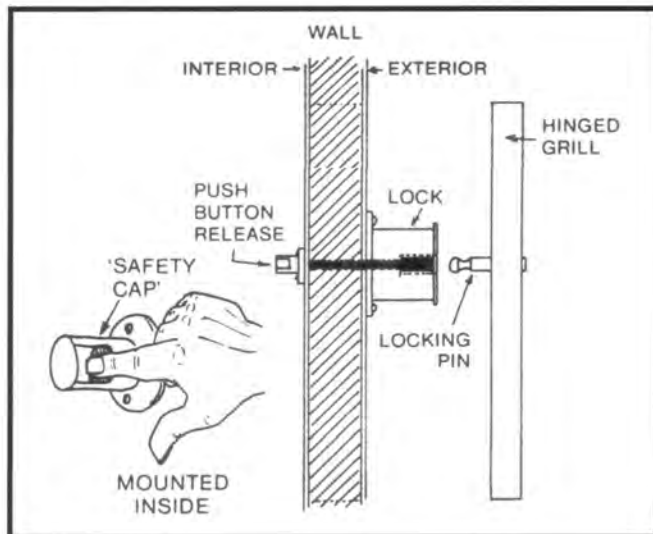

DELUXE PUSH BUTTON RELEASE

HD-WGFRPBD

- Convenient push button window guard fire release.

Packed 20 sets/box

Weight 37 lbs/box



CEL TUBE BENDER



TUBE BENDER

HD-TOTB

- 1-1/8" Heavy duty adjustment Rod
- Square tubing guiding gear (STG101)
- Heavy duty pillow block axle
- Removable crank handle
- Components made of 1018 cold rolled steel heat treated for durability and strength
- Capacity: Flat/Recatangular tubing 1/2" to 2"

Packed each

48 lbs/each

HARDWARE - FASTENER

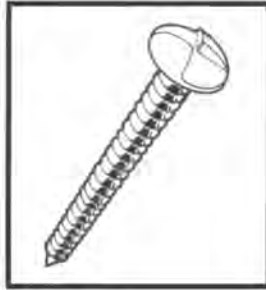

Black Oxide
Heat-Treated
Threaded Full Length
Truss Head



1018 Black Oxide Steel
Heat Treated
Threaded Full Length



ONE WAY SCREW

Item	Size	Pk/box	Wgt/box
HD-SOWL11	1/4" x 1"	3500	48 lbs.
HD-SOWL115	1/4" x 1-1/2"	4,000	69 lbs.
HD-SOWL12	1/4" x 2"	2,000	43 lbs.
HD-SOWL125	1/4" x 2-1/2"	1,200	32 lbs.
HD-SOWL13	1/4" x 3"	1,000	31 lbs.
HD-SOWL515	5/16" x 1-1/2"	2,000	48 lbs.
HD-SOWL52	5/16" x 2"	1,000	34 lbs.
HD-SOWL53	5/16" x 3"	800	39 lbs.
HD-SOWL54	5/16" x 4"	500	32 lbs.
HD-SOWL55	5/16" x 5"	500	36 lbs.
HD-SOWL56	5/16" x 6"	400	35 lbs.

TORX TAMPER RESISTANT SCREW

Item	Size	Pk/box	Wgt/box
HD-ST14112	1/4" x 1-1/2"	2,000	43 lbs.
HD-ST142	1/4" x 2"	2,000	38 lbs.
HD-ST143	1/4" x 3"	1,000	55 lbs.

LAG SHIELD

Item	Size	Pk/box	Wgt/box
HD-LS516S	5/16" x 1-1/4"	1,000	43 lbs.
HD-LS516L	5/16" x 1-3/4"	1,000	38 lbs.
HD-LS38S	3/8" x 1-3/4"	1,000	55 lbs.
HD-LS38L	3/8" x 2-1/2"	500	57 lbs.

SLEEVE ANCHOR

Item	Size	Pk/box	Wgt/box
HD-SA516112	5/16" x 1-1/2"	1,000	41 lbs.
HD-SA516212	5/16" x 2-1/2"	1,000	57 lbs.
HD-SA38178	3/8" x 1-7/8"	700	56 lbs.
HD-SA383	3/8" x 3"	600	58 lbs.
HD-SA123	1/2" x 3"	250	48 lbs.

HARDWARE - FASTENER



DRIVE-IN ANCHOR

Item	Size	Pk/box	Wgt/box
HD-ANI11	1/4" x 1"	2,500	50 lbs.
HD-ANI114	1/4" x 1-1/4"	2,000	44 lbs.
HD-ANI112	1/4" x 1-1/2"	2,000	50 lbs.
HD-ANI12	1/4" x 2"	1,250	40 lbs.



HEX HEAD LAG SCREW

Item	Size	Pk/box	Wgt/box
HD-SHX1	1/4" x 1"	3500	46 lbs.
HD-SHX115	1/4" x 1-1/2"	2500	50 lbs.
HD-SHX12	1/4" x 2"	2,000	48 lbs.
HD-SHX13	1/4" x 3"	1,500	32 lbs.
HD-SHX51	5/16" x 1"	2,000	48 lbs.
HD-SHX52	5/16" x 2"	1,000	40 lbs.
HD-SHX53	5/16" x 3"	800	45 lbs.
HD-SHX54	5/16" x 4"	600	46 lbs.
HD-SHX32	3/8" x 2"	800	36 lbs.
HD-SHX33	3/8" x 3"	600	49 lbs.
HD-SHX34	3/8" x 4"	400	43 lbs.

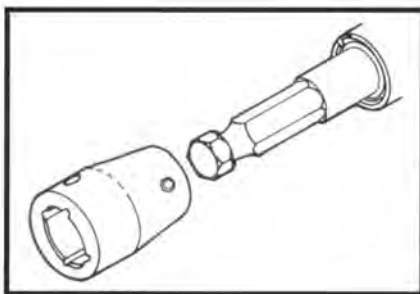

ONE-WAY ADAPTER

HD-TADPT

Adapter for 5/16" Tool
Packed 10 pcs/box

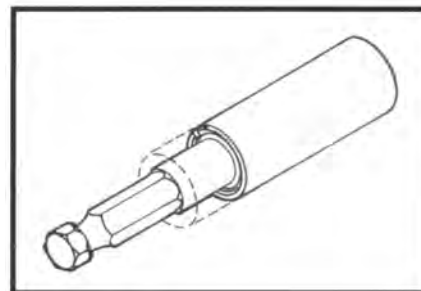

ONE-WAY DRIVER

HD-TOWD516

One Way Driver 5/16"
Packed 10 pcs/box

METAL STAMPING



WELD TAB 101		
Item	HD-WT101	HD-WT101XL
H	1-1/2"	1-1/2"
W	1"	1-1/2"
Thickness	1/8"	3/16"
Hole Dia.	3/8"	3/8"
Pk	1,000	200
Wgt	46 lbs.	22 lbs.



WELD TAB 105	
Item	HD-WT105
H	2-3/4"
W	2-5/8"
Base	7/8"
Thickness	1/8"
Hole Dia.	3/8"
Pk	500
Wgt	50 lbs.



WELD TAB 102		
Item	HD-WT102	HD-WT102XL
H	2-3/8"	2-3/8"
W	1"	1-1/2"
Thickness	1/8"	3/16"
Hole Dia.	3/8"	3/8"
Pk	1,000	250
Wgt	62 lbs.	34 lbs.



WELD TAB 106	
Item	HD-WT106
H	3-3/8"
W	2"
Thickness	1/8"
Hole Dia.	3/8"
Pk	500
Wgt	56 lbs.



WELD TAB 103	
Item	HD-WT103
H	2-1/2"
W	2"
Base	1"
Thickness	1/8"
Hole Dia.	3/8"
Pk	500
Wgt	46 lbs.



WELD TAB 107	
Item	HD-WT107
H	3-1/2"
W	1-1/2"
Thickness	3/16"
Hole Dia.	3/8"
Pk	250
Wgt	58 lbs.



HD-WT104



HD-WT104S

WELD TAB 104 "L BRACKET"			
Item	HD-WT104	HD-WT104XL	HD-WT104S
H	1-3/4"	1-3/4"	1-1/2"
W	1"	1-1/2"	1-1/2"
Length	3-1/2"	4"	1-1/2"
Thickness	3/16"	3/16"	3/16"
Hole Dia.	3/8"	3/8"	3/8"
Pk	250	150	250
Wgt	59 lbs.	60 lbs.	45 lbs.

METAL STAMPING



WELD TAB 108	
Item	HD-WT108
H	3-1/4"
W	1"
Thickness	1/8"
Hole Dia.	3/8"
Pk	500
Wgt	48 lbs.



WELD TAB 202	
Item	HD-WT202
L	4"
W	2"
Thickness	3/16"
Hole Dia.	3/8"
Pk	100
Wgt	38 lbs.



WELD TAB 109	
Item	HD-WT109
H	4"
W	1-1/2"
Thickness	3/16"
Hole Dia.	3/8"
Pk	200
Wgt	55 lbs.



WELD TAB 209	
Item	HD-WT209
L	5"
W	2"
Thickness	3/16"
Hole Dia.	3/8"
Pk	100
Wgt	41 lbs.



WELD TAB 204 WIDE "L BRACKET"		
Item	HD-WT204S	HD-WT204XL
H	2"	2"
W	2"	2"
Length	2"	4"
Thickness	3/16"	3/16"
Hole Dia.	3/8"	3/8"
Pk	150	100
Wgt	44 lbs.	53 lbs.

“Consistent quality you can rely on. We stand by our products with excellent customer service.”

METAL STAMPING



FENCE MOUNTING BRACKET (MILL FINISH)

Item#	Size	Hole	Thickness	Wgt.	Pk
HD-WT110*	1"	3/8"	3/16"	28 lbs.	100/box
HD-WT124	1-1/4"	3/8"	3/16"	30 lbs.	100/box
HD-WT125	1-1/2"	3/8"	3/16"	32 lbs.	100/box
HD-WT220	2"	3/8"	3/16"	55 lbs.	80/box

*HD-WT110 finished in powder-coated black.



BASE PLATE

Item#	Size	Hole Dia.	Thickness	Wgt.	Pk
HD-WT113	3"x3"	3/8"	5/32"	35 lbs.	100/box
HD-WT114	4"x4"	3/8"	5/32"	53 lbs.	80/box
HD-WT115	5"x5"	7/16"	1/4"	64 lbs.	40/box
HD-WT116	6"x6"	7/16"	1/4"	60 lbs.	25/box
HD-WT118	8"x8"	7/16"	1/4"	64 lbs.	16/box
HD-WT210	10"x10"	1/2"	5/16"	77 lbs.	8/box



BEVELED SQUARE BASE PLATE

Item#	Size	Hole Dia.	Thickness	Wgt.	Pk
HD-WT303B	3"	1/2"	3/16"	28 lbs.	60/box
HD-WT304B	4"	1/2"	3/16"	37 lbs.	45/box
HD-WT305B	5"	1/2"	3/16"	26 lbs.	20/box
HD-WT306B	6"	5/8"	3/16"	28 lbs.	15/box
HD-WT308B	8"	5/8"	1/4"	21 lbs.	5/box
HD-WT310B	10"	5/8"	1/4"	26 lbs.	4/box



BEVELED ROUND BASE PLATE

Item#	Size	Hole Dia.	Thickness	Wgt.	Pk
HD-WT5RB	4-3/4"	7/16"	3/16"	24 lbs.	25/box
HD-WT6RB	5-3/4"	7/16"	3/16"	27 lbs.	20/box
HD-WT7RB	6-3/4"	9/16"	1/4"	24 lbs.	10/box
HD-WT8RB	7-3/4"	9/16"	1/4"	15 lbs.	4/box

METAL STAMPING



90 DEGREE MOUNTING BRACKET

Item#	Size	Hole Dia.	Thickness	Wgt.	Pk
HD-MB3	2-5/16"	5/16"	3/16"	36 lbs.	40/box
HD-MB4	3-5/16"	5/16"	3/16"	22 lbs.	30/box
HD-MB6	5-7/8"	3/8"	1/4"	41 lbs.	20/box
HD-MB8	7-7/8"	3/8"	1/4"	52 lbs.	20/box



RAISED BASE PLATE

Item#	Size	Hole Dia.	Thickness	Wgt.	Pk
HD-FSH41	4"x4"x1"	7/16"	1/8"	56 lbs.	100/box
HD-FSH4112	4"x4"x1"-1/2"	7/16"	1/8"	52 lbs.	100/box
HD-FSH4114	4"x4"x1-1/4"	7/16"	1/8"	54 lbs.	100/box
HD-FSH42	5-1/4"x5-1/4"x2"	7/16"	1/8"	60 lbs.	50/box



STEEL DISC

Item#	Size (Dia.)	Thickness	Wgt	Pk
HD-SD112	1-1/2"	3.5 mm	35 lbs.	500/box
HD-SD158	1-5/8"	3.5 mm	41 lbs.	500/box
HD-SD178	1-7/8"	3.5 mm	48 lbs.	500/box
HD-SD335	3"	3.5 mm	55 lbs.	200/box
HD-SD36	3"	6.0 mm	48 lbs.	100/box

METAL STAMPING



BATWING - FEMALE						
Item	Size (in.)	H	L	W	Wgt	Pk
HD-BWF12	1/2"	1-1/16"	1-1/2"	1"	57 lbs.	500/bx
HD-BWF58	5/8"	1-1/4"	1-5/8"	1-1/8"	40 lbs.	300/bx
HD-BWF34	3/4"	1-5/16"	1-5/8"	1-1/4"	46 lbs.	300/bx



BATWING - MALE (ROD HEIGHT 1")						
Item	Size (in.)	H	L	W	Wgt	Pk
HD-BWM12	1/2"	1-1/16"	1-1/2"	1"	86 lbs.	500/bx
HD-BWM58	5/8"	1-1/4"	1-5/8"	1-1/8"	54 lbs.	200/bx
HD-BWM34	3/4"	1-5/16"	1-5/8"	1-1/4"	55 lbs.	200/bx

STAIR & RAIL BRACKETS



HANDRAIL BRACKET		
Item	HD-BH300	HD-BH300R
Fit	Flat	Round
H	3-1/4"	3-1/4"
W	2-3/4"	2-3/4"
Gauge	8	8
Clearance	3"	3"
Pk	100	100
Wgt	52 lbs.	52 lbs.



HANDRAIL BRACKET	
Item	HD-BH302
Fit	Flat
H	3-1/4"
W	2"
Gauge	10
Clearance	3"
Pk	100
Wgt	34 lbs.



HANDRAIL BRACKET		
Item	HD-BH212	HD-BH212R
Fit	Flat	Round
H	3-1/4"	3-1/4"
W	2-3/4"	2-3/4"
Gauge	8	8
Clearance	2-1/2"	2-1/2"
Pk	100	100
Wgt	52 lbs.	52 lbs.

METAL RINGS



STEEL TUBING RING - 1/2" SQUARE TUBING

Item#	Size (dia.)	Gauge	Wgt	Pk
HD-TR314	3-1/4"	18	20 lbs.	100/box
HD-TR315	3-1/2"	18	22 lbs.	100/box
HD-TR4	4"	18	24 lbs.	100/box
HD-TR414	4-1/4"	18	25 lbs.	80/box
HD-TR412	4-1/2"	18	22 lbs.	80/box
HD-TR5	5"	18	26 lbs.	80/box
HD-TR514	5-1/4"	18	17 lbs.	50/box
HD-TR512	5-1/2"	18	18 lbs.	50/box
HD-TR6	6"	18	20 lbs.	50/box
HD-TR7	7"	18	15 lbs.	30/box
HD-TR8	8"	18	17 lbs.	30/box
HD-TR10	10"	18	14 lbs.	20/box



STEEL TUBING RING - 1/2" ROUND TUBING

Item#	Size (dia.)	Wgt	Gauge	Pk
HD-TRR312	3-1/2"	17 lbs.	16	100/box
HD-TRR4	4"	20 lbs.	16	100/box



STEEL TAILED RING

Item#	Size	Mtl.	Wgt	Pk
IND-63102	3-15/16"	1/2"x1/4"	44 lbs.	80pc
IND-63104	4-11/16"	1/2"x1/4"	55 lbs.	100pc



SCROLLED STEEL RING

Item#	Size	Mtl.	Wgt.	Pk
IND-63001	4"	1/2"x1/4"	40 lbs.	120/box
IND-63006	4-1/2"	1/2"x1/4"	36 lbs.	90/box
IND-63008	5"	1/2"x1/4"	32 lbs.	70/box
IND-63201	4"	1/2"x1/2"	55 lbs.	100/box



63102 depicted

PRESSED STEEL CAPS & SPHERES



STEEL HALF SPHERE - 16 GAUGE

Item	Size	Wgt	Pk
HD-BSH112	1-1/2"	12 lbs.	200/box
HD-BSH2	2"	19 lbs.	100/box
HD-BSH212	2-1/2"	17 lbs.	50/box
HD-BSH3	3"	11 lbs.	40/box
HD-BSH4	4"	12 lbs.	24/box
HD-BSH5	5"	15 lbs.	12/box
HD-BSH6	6"	13 lbs.	12/box
HD-BSH8	8"	16 lbs.	8/box
HD-BSH12	12"	18 lbs.	6/box



HOLLOW STEEL BALL - 16 GAUGE

Item	Size	Wgt	Pk
HD-BS112	1-1/2"	11 lbs.	100/box
HD-BS2	2"	12 lbs.	50/box
HD-BS212	2-1/2"	19 lbs.	50/box
HD-BS3	3"	11 lbs.	20/box
HD-BS4	4"	12 lbs.	12/box
HD-BS5	5"	10 lbs.	6/box
HD-BS6	6"	13 lbs.	6/box
HD-BS8	8"	16 lbs.	4/box
HD-BS12	12"	18 lbs.	2/box



PRESSED STEEL POST CAP

Item	Size	Wgt	Pk
HD-CS34	3/4"	10 lbs.	500/box
HD-CS1	1"	16 lbs.	500/box
HD-CS114	1-1/4"	22 lbs.	500/box
HD-CS112	1-1/2"	25 lbs.	400/box
HD-CS2	2"	40 lbs.	400/box
HD-CS212	2-1/2"	35 lbs.	200/box
HD-CS3	3"	43 lbs.	200/box
HD-CS312	3-1/2"	27 lbs.	150/box
HD-CS4	4"	33 lbs.	100/box
HD-CS5	5"	45 lbs.	100/box
HD-CS6	6"	33 lbs.	50/box
HD-CS8	8"	9 lbs.	6/box

PLASTIC CAPS



SQUARE PLASTIC CAPS (BLACK/WHITE)

Item	Size	Pc/Box	Weight
PLS-CAP12	1/2" x 1/2"	5000	10 lbs.
PLS-CAP58	5/8" x 5/8"	5000	18 lbs.
PLS-CAP34	3/4" x 3/4"	3000	14 lbs.
PLS-CAP1	1" x 1"	1000	10 lbs.
PLS-CAP114	1-1/4" x 1-1/4"	1000	11 lbs.
PLS-CAP112	1-1/2" x 1-1/2"	1000	15 lbs.
PLS-CAP2	2" x 2"	400	10 lbs.
PLS-CAP3	3" x 3"	200	12 lbs.
PLS-CAP34X112	3/4" x 1-1/2"	1000	11 lbs.
PLS-CAP1X112	1" x 1-1/2"	1000	12 lbs.
PLS-CAP1X2	1" x 2"	1000	14 lbs.



ROUND PLASTIC CAPS (BLACK/WHITE)

Item	Size (Dia.)	Pk	Wgt
PLS-CAPR12	1/2"	5000	10 lbs.
PLS-CAPR58	5/8"	5000	18 lbs.
PLS-CAPR34	3/4"	3000	14 lbs.
PLS-CAPR1	1"	1000	10 lbs.
PLS-CAPR114	1-1/4"	1000	11 lbs.
PLS-CAPR112	1-1/2"	1000	15 lbs.
PLS-CAPR2	2"	400	10 lbs.
PLS-CAPR3	3"	200	12 lbs.

PLASTIC SPEAR

PLS-P217B

Available in 1/2" 5/8", 3/4"

Packed 400 pcs/box

Weight: 16 lbs

* Black finish only



PLASTIC SPEAR

PLS-P227B

Available in 1/2" 5/8", 3/4"

Packed 400 pcs/box

Weight: 16 lbs

* Black finish only



PLASTIC SPEAR

PLS-P215

Available in 1/2" 5/8", 3/4"

Packed 400 pcs/box

Weight: 16 lbs

* Black finish only



WELD ON FITTINGS

90 DEGREE STEEL WELD-ON PIPE ELBOWS (SCH 40)



Item#	Size (IDia.)	Inside Radius	Wgt	Pk
FIT-E9010	1"	0.8"	34 lbs.	100/box
FIT-E9014	1-1/4"	1.10"	28 lbs.	50/box
FIT-E9012	1-1/2"	1.35"	31 lbs.	40/box
FIT-E9020	2"	1.80"	28 lbs.	20/box
FIT-E9030	3"	2.75"	46 lbs.	10/box
FIT-E9040	4"	3.75"	35 lbs.	4/box

45 DEGREE STEEL WELD-ON PIPE ELBOWS (SCH 40)



Item#	Size (Dia.)	Inside Radius	Wgt	Pk
FIT-E4514	1-1/4"	1.10"	15 lbs.	50/box
FIT-E4512	1-1/2"	1.35"	15 lbs.	40/box
FIT-E4520	2"	1.80"	13 lbs.	20/box
FIT-E4530	3"	2.75"	2.5 lbs.	Each
FIT-E4540	4"	3.75"	4.0 lbs.	Each

STEEL WELD-ON PIPE END-CAPS (SCH 40)



Item#	Size (Dia.)	Wgt	Pk
FIT-EC10	1"	12 lbs.	100/box
FIT-EC114	1-1/4"	13 lbs.	50/box
FIT-EC112	1-1/2"	14 lbs.	50/box
FIT-EC20	2"	17 lbs.	40/box
FIT-EC30	3"	12 lbs.	10/box
FIT-EC40	4"	12 lbs.	6/box

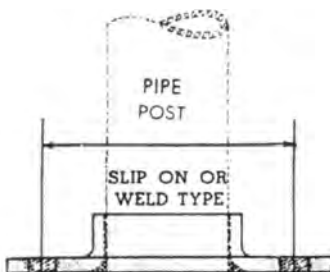

RAISED STEEL PIPE FLANGE - NO HOLE (SCH 40)

Item#	Fit	I.D.	O.D.	Flange Dia.	Wgt	Pk
HD-FRH114NH	1-1/4"	1-5/8"	1-7/8"	3-3/4"	40 lbs.	100/box
HD-FRH112NH	1-1/2"	1-7/8"	2-1/8"	4-1/4"	50 lbs.	100/box
HD-FRH200NH	2"	2-3/8"	2-9/16"	4-3/4"	31 lbs.	50/box

RAISED STEEL PIPE FLANGE W/ HOLES (SCH 40)



Item#	Fit	I.D.	O.D.	Flange Dia.	Wgt	Pk
HD-FRH114	1-1/4"	1-5/8"	1-7/8"	3-3/4"	40 lbs.	100/box
HD-FRH112	1-1/2"	1-7/8"	2-1/8"	4-1/4"	50 lbs.	100/box
HD-FRH200	2"	2-3/8"	2-9/16"	4-3/4"	31 lbs.	50/box

TWISTED BALUSTERS



IND-48-1C

Mtl: 1/2" Sq. Bar
 H: 39"
 Weight: 2.6 lbs.
 Packed: 5 pcs/bundle



IND-48-1LC

Mtl: 1/2" Sq. Bar
 H: 47"
 Weight: 3.3 lbs.
 Packed: 5 pcs/bundle



IND-48-2C

Mtl: 1/2" Sq. Bar
 H: 39"
 Weight: 2.4 lbs.
 Packed: 5 pcs/bundle



IND-48-2LC

Mtl: 1/2" Sq. Bar
 H: 47"
 Weight: 3.2 lbs.
 Packed: 5 pcs/bundle



IND-48-3C

Mtl: 1/2" Sq. Hammered
 H: 39"
 Weight: 2.4 lbs.
 Packed: 5 pcs/bundle



IND-48-3LC

Mtl: 1/2" Sq. Hammered
 H: 47"
 Weight: 3.4 lbs.
 Packed: 5 pcs/bundle



IND-48-4C

Mtl: 1/2" Sq. Hammered
 H: 39"
 Weight: 3.4 lbs.
 Packed: 5 pcs/bundle



IND-48-4LC

Mtl: 1/2" Sq. Hammered
 H: 47"
 Weight: 3.2 lbs.
 Packed: 5 pcs/bundle

TWISTED BALUSTERS



IND-49-3C

Mtl: 1/2" Sq. Bar
 H: 39-1/2"
 W: 7"
 Weight: 6 lbs.
 Packed: 10 pcs/bundle



IND-50-5C

Mtl: 1/2" Sq. Bar
 H: 39-1/2"
 W: 1-1/4"
 Weight: 2.1 lbs.
 Packed: 20 pcs/bundle



IND-50-5LC

Mtl: 1/2" Sq. Bar
 H: 47"
 W: 1-1/4"
 Weight: 3.5 lbs.
 Packed: 20 pcs/bundle



IND-50-6C

Mtl: 1/2" Sq. Bar
 H: 39-1/2"
 W: 1-1/4"
 Weight: 2.2 lbs.
 Packed: 20 pcs/bundle



IND-50-6LC

Mtl: 1/2" Sq. Bar
 H: 47"
 W: 1-1/4"
 Weight: 2.9 lbs.
 Packed: 20 pcs/bundle



IND-50-7C

Mtl: 1/2" Sq. Bar
 H: 39"
 W: 5-1/2"
 Weight: 2.8 lbs.
 Packed: 12 pcs/bundle



IND-50-7LC

Mtl: 1/2" Sq. Bar
 H: 47"
 W: 5-1/2"
 Weight: 3.5 lbs.
 Packed: 12 pcs/bundle



IND-50-8C

Mtl: 1/2" Sq. Bar
 H: 39-1/2"
 W: 5-1/2"
 Weight: 3.4 lbs.
 Packed: 12 pcs/bundle

TWISTED BALUSTERS



IND-50-8LC

Mtl: 1/2" Sq. Bar
 H: 47"
 W: 5-1/2"
 Weight: 4.1 lbs.
 Packed: 12 pcs/bundle



IND-51-3C

Mtl: 1/2" Sq. Bar
 H: 35-1/2"
 W: 11-3/4"
 Weight: 8.5 lbs.
 Packed: 10 pcs/bundle



IND-52-2C

Double Grooved
 Mtl: 1/2" Sq. Bar
 H: 35-1/2" W: 9-1/4"
 Weight: 5.5 lbs.
 Packed: 8 pcs/bundle



IND-53-1C

Mtl: 1/2" Sq. Bar
 H: 35-1/2"
 W: 9-1/4"
 Weight: 4.5 lbs.
 Packed: 6 pcs/bundle



IND-52-3C

Double Grooved
 Mtl: 1/2" Sq. Bar
 H: 35-1/2"
 Weight: 2.5 lbs.
 Packed: 20 pcs/bundle



IND-53-3C

Mtl: 1/2" Sq. Bar
 H: 39-1/2"
 Weight: 2.5 lbs.
 Packed: 20 pcs/bundle



IND-53-347C

Mtl: 1/2" Sq. Bar
 H: 47"
 Weight: 3.0 lbs.
 Packed: 20 pcs/bundle



IND-65-8C

Mtl: 1/2" Sq. Bar
 H: 39-1/2"
 Weight: 2.5 lbs.
 Packed: 20 pcs/bundle



IND-65-847C

Mtl: 1/2" Sq. Bar
 H: 47"
 Weight: 4 lbs.
 Packed: 20 pcs/bundle

STAIR & RAIL BALUSTER



IND-52-A-4SC

Mtl: 1/2" x 1/4" Bar
 H: 39-1/2"
 W: 7-1/4"
 Weight: 4 lbs.
 Packed: 10 pcs/bundle



IND-52-4SLC

Mtl: 1/2" x 1/4" Bar
 H: 44-1/4"
 W: 7-1/4"
 Weight: 4.5 lbs.
 Packed: 10 pcs/bundle



IND-60-3C

Mtl: 1/2" Sq. Bar
 H: 35-1/2"
 W: 5-1/4"
 Weight: 4 lbs.
 Packed: 10 pcs/bundle



IND-64-B-2C

Mtl: 1/2" Sq. Bar
 H: 35-1/2"
 W: 8-5/8"
 Weight: 4 lbs.
 Packed: 5 pcs/bundle



IND-64-F-3C

Mtl: 1/2" Sq. Bar
 H: 39"
 W: 1-1/4"
 Weight: 3 lbs.
 Packed: 20 pcs/bundle



IND-64-F-3LC

Mtl: 1/2" Sq. Bar
 H: 47"
 Weight: 3.7 lbs.
 Packed: 20 pcs/bundle



IND-64-F-5C

Mtl: 1/2" Sq. Bar
 H: 39-1/2"
 Weight: 3.7 lbs.
 Packed: 20 pcs/bundle

STAIR & RAIL BALUSTER



IND-64-F-5LC

Mtl: 5/8" Sq. Bar
 H: 47"
 Weight: 3.7 lbs.
 Packed: 20 pcs/bundle



IND-64-F-9C

Mtl: 9/16" Sq. Bar
 H: 35-1/2"
 W: 4-1/4"
 Weight: 4.2 lbs.
 Packed: 12 pcs/bundle



IND-64-F-9DC

Double Faced
 Mtl: 9/16" Sq. Bar
 H: 35-1/2"
 W: 4-1/4"
 Weight: 4.5 lbs.
 Packed: 12 pcs/bundle



IND-64-I-2C

Mtl: 9/16" Sq. Bar
 H: 39-1/4"
 Weight: 3.6 lbs.
 Packed: 12 pcs/bundle



IND-64-I-2LC

Mtl: 9/16" Sq. Bar
 H: 47"
 Weight: 4.5 lbs.
 Packed: 12 pcs/bundle



IND-64-I-3C

Mtl: 9/16" Sq. Bar
 H: 39-1/2"
 Weight: 3.3 lbs.
 Packed: 12 pcs/bundle



IND-64-I-3LC

Mtl: 9/16" Sq. Bar
 H: 47"
 Weight: 4.2 lbs.
 Packed: 12 pcs/bundle

STAIR & RAIL BALUSTERS



IND-70-D-1C

Mtl: 9/16" Sq. Bar
 H: 39" Weight: 3 lbs.
 Packed: 20 pcs/bundle

IND-70-D-1LC
 47" Version



IND-541-2C

Mtl: 1/2" Dia. Rnd
 H: 35-1/2"
 W: 13-1/2"
 Weight: 12 lbs.
 Packed: 4 pcs/bundle



IND-12040

4-Side Grooved Edge
 Mtl: 5/16" Dia. Rnd
 H: 36" W: 9"
 Weight: 6.3 lbs.
 Packed: 5 pcs/bundle



IND-12041

Mtl: 5/16 x 5/8"
 H: 36"
 W: 7-1/2"
 Weight: 6.6 lbs.
 Packed: 5 pcs/bundle



IND-12042

Mtl: 5/16" x 5/8"
 H: 36"
 W: 9"
 Weight: 5.5 lbs.
 Packed: 8 pcs/bundle



IND-12043

Mtl: 1/2" Sq. Bar
 H: 35-1/2"
 W: 7"
 Weight: 4.4 lbs.
 Packed: 10 pcs/bundle



IND-12027

Mtl: 1/2" Sq. Bar
 H: 35-1/2"
 W: 5"
 Weight: 4 lbs.
 Packed: 10 pcs/bundle

STAIR & RAIL BALUSTERS



IND-12026

Mtl: 5/16 x 5/8"
 H: 36"
 W: 7-1/2"
 Weight: 6.6 lbs.
 Packed: 5 pcs/bundle



IND-12065

Mtl: 5/16" x 5/8"
 H: 36"
 W: 9"
 Weight: 5.5 lbs.
 Packed: 8 pcs/bundle



IND-12006

Mtl: 1/2" Sq. Bar
 H: 35-1/2"
 W: 7"
 Weight: 4.4 lbs.
 Packed: 10 pcs/bundle



IND-12008

Mtl: 1/2" Sq. Bar
 H: 35-1/2"
 W: 5"
 Weight: 4 lbs.
 Packed: 10 pcs/bundle



IND-12704

Mtl: 5/16 x 5/8"
 H: 36"
 W: 7-1/2"
 Weight: 6.6 lbs.
 Packed: 5 pcs/bundle



IND-12704DB

Mtl: 5/16" x 5/8"
 H: 36"
 W: 9"
 Weight: 5.5 lbs.
 Packed: 8 pcs/bundle



IND-12705

Mtl: 1/2" Sq. Bar
 H: 35-1/2"
 W: 7"
 Weight: 4.4 lbs.
 Packed: 10 pcs/bundle



IND-12905

Mtl: 1/2" Sq. Bar
 H: 35-1/2"
 W: 5"
 Weight: 4 lbs.
 Packed: 10 pcs/bundle

STAIR & RAIL BALUSTERS



IND-12908

Mtl: 1/2" x 5/8"
 H: 39-1/4"
 Weight: 33 lbs.
 Packed: 10 pcs/bundle



IND-12068

Mtl: 9/16" Sq. Bar
 H: 39-1/8"
 W: 6"
 Weight: 44 lbs.
 Packed: 10 pcs/bundle



IND-108-A-1

Mtl: 1/2" Sq. Hammered
 H: 39-1/2"
 Weight: 30 lbs.
 Packed: 10 pcs/bundle



IND-108-A-2

Mtl: 1/2" Hammered
 H: 39-1/2"
 Weight: 37 lbs.
 Packed: 10 pcs/bundle



IND-105-1C

Mtl: 1/2" Sq. Hammered
 H: 39-5/16"
 Weight: 33 lbs.
 Packed: 10 pcs/bundle



IND-105-1LC

Mtl: 1/2" Sq. Hammered
 H: 47"
 Weight: 34 lbs.
 Packed: 10 pcs/bundle



IND-105-2C

Mtl: 1/2" Sq. Hammered
 H: 39-5/16"
 Weight: 33 lbs.
 Packed: 10 pcs/bundle



IND-105-2LC

Mtl: 1/2" Sq. Hammered
 H: 47"
 Weight: 35 lbs.
 Packed: 10 pcs/bundle

STAIR & RAIL BALUSTERS



IND-109-3C

Mtl: 1/2" Sq. Hammered
 H: 39-1/4"
 Weight: 33 lbs./bundle
 Packed: 10 pcs/bundle



IND-64-L-3C

Mtl: 1/2" Dia.
 H: 35-1/2"
 Weight: 23 lbs./bundle
 Packed: 10 pcs/bundle



IND-64-L-4C

Mtl: 1/2" Dia.
 H: 35-1/2"
 Weight: 23 lbs./bundle
 Packed: 10 pcs/bundle



IND-64-R-4C

Mtl: 1/2" Dia.
 H: 39-1/2"
 Weight: 37 lbs./bundle
 Packed: 10 pcs/bundle



IND-64-R-3C

Mtl: 1/2" Dia.
 H: 39-1/4"
 Weight: 27 lbs./bundle
 Packed: 10 pcs/bundle



IND-12703

Mtl: 3/8" Sq.
 H: 39-1/2"
 Weight: 20 lbs./bundle
 Packed: 10 pcs/bundle



IND-576-2C

Mtl: 1/2" Dia.
 H: 35-1/2"
 Weight: 25 lbs./bundle
 Packed: 20 pcs/bundle



IND-576-4C

Mtl: 1/2" Dia.
 H: 35-1/2"
 Weight: 25 lbs./bundle
 Packed: 20 pcs/bundle

ROUND BALUSTERS



IND-12707

Mtl: 9/16 Dia. Hammered
 H: 39-5/16"
 Weight: 33 lbs./bundle
 Packed: 10 pcs/bundle



IND-12710

Mtl: 1/2" Dia. Hammered
 H: 39-5/16"
 Weight: 44 lbs./bundle
 Packed: 10 pcs/bundle



IND-12710S

Mtl: 1/2" Dia. Hammered
 H: 39-5/16"
 Weight: 30 lbs./bundle
 Packed: 10 pcs/bundle



IND-604-7C

Mtl: 5/8" Dia. Hammered
 H: 35-1/4"
 Weight: 30 lbs./bundle
 Packed: 10 pcs/bundle



IND-98-1C

Mtl: 9/16" Sq. Hammered
 H: 39-1/2"
 Weight: 50 lbs./bundle
 Packed: 10 pcs/bundle



IND-499-1

Mtl: 1/2" Dia.
 H: 39-1/4"
 Weight: 30 lbs./bundle
 Packed: 10 pcs/bundle



IND-499-2

Mtl: 1/2" Dia.
 H: 39-1/2"
 Weight: 18 lbs./bundle
 Packed: 10 pcs/bundle



IND-604-6C

Mtl: 5/8" Dia. Hammered
 H: 35-1/4"
 Weight: 40 lbs./bundle
 Packed: 10 pcs/bundle

STEEL TUBE COMPONENTS



IND-154-2C

Mtl: 1-1/4" Dia.
H: 6"
Weight: 15 lbs./bag
Packed: 50 pcs/bag

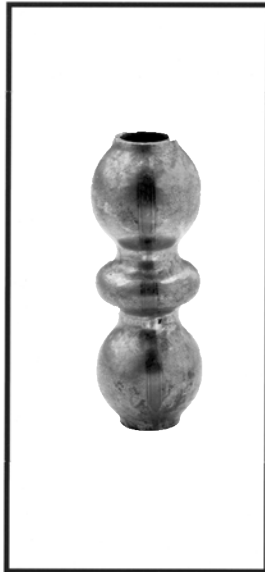

IND-155-1C

Mtl: 1-1/4" Dia.
H: 3-3/4"
Weight: 10 lbs./bag
Packed: 50 pcs/bag



IND-155-2C

Mtl: 1-1/4" Dia.
H: 2-1/2"
Weight: 10 lbs./bag
Packed: 50 pcs/bag



IND-155-4C

Mtl: 1-1/4" Dia.
H: 3/4"
Weight: 5 lbs./bag
Packed: 50 pcs/bag

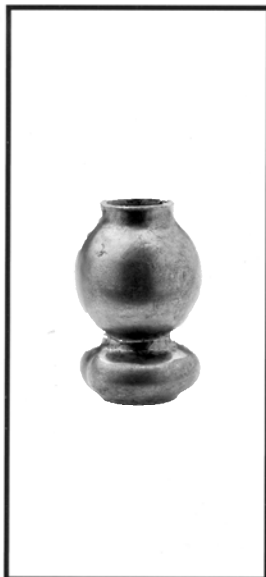

IND-155-3C

Mtl: 1-1/4" Dia.
H: 1-7/8"
Weight: 10 lbs./bag
Packed: 50 pcs/bag

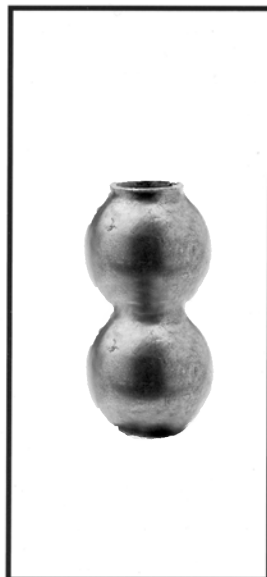

IND-155-6C

Mtl: 1-1/4" Dia.
H: 2-1/2"
Weight: 10 lbs./bag
Packed: 50 pcs/bag



IND-148-1C

Mtl: 1-1/4" Dia.
H: 35-1/2"
Weight: 40 lbs./bundle
Packed: 20 pcs/bundle

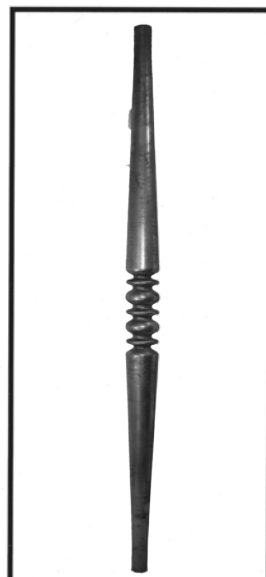

IND-148-2C

Mtl: 1-1/4" Dia.
H: 35-1/2"
Weight: 40 lbs./bundle
Packed: 20 pcs/bundle

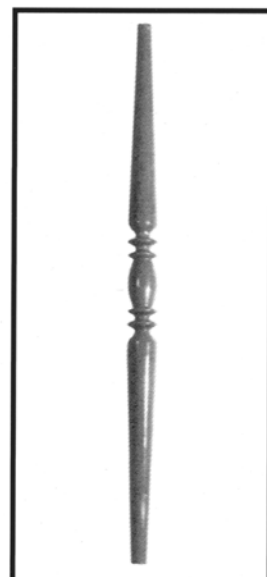

IND-149-1C

Mtl: 1-1/4" Dia.
H: 35-1/2"
Weight: 40 lbs./bundle
Packed: 20 pcs/bundle

FORGED NEWEL POSTS

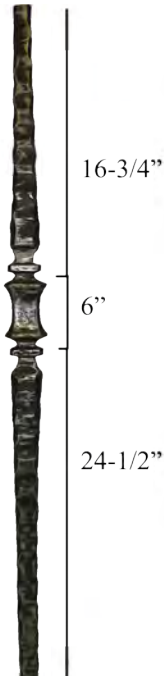

IND-14003

Mtl: 1" Sq Hammered
 H: 47"
 Weight: 15 lbs.
 Packed: Each



IND-14008

Mtl: 1" Sq Hammered
 H: 47"
 Weight: 12.5 lbs.
 Packed: Each



IND-14016

Mtl: 1" Sq Hammered
 H: 47"
 Weight: 14 lbs.
 Packed: Each



IND-14048

Mtl: 1" Sq Hammered
 H: 47"
 Weight: 8.9 lbs.
 Packed: Each



IND-14049

Mtl: 1" Sq Hammered
 H: 47"
 Weight: 13.5 lbs.
 Packed: Each



IND-64-F-1C

Mtl: 1" Sq Hammered
 H: 47"
 Weight: 13 lbs.
 Packed: Each



IND-50-25

Mtl: 1" Sq Hammered
 H: 47"
 Weight: 13 lbs.
 Packed: Each



IND-53-25

Mtl: 1" Sq Hammered
 H: 47"
 Weight: 13 lbs.
 Packed: Each

BALCONY ELEMENTS



IND-64-H-10

Mtl: 9/16" Sq. Bar
 H: 35-7/16"
 W: 1-3/16
 Weight: 15.5 lbs
 Packed: 5 pcs/bundle

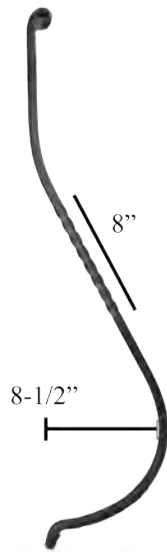

IND-47-10

Mtl: 9/16" Sq. Bar
 H: 35-1/2"
 Weight: 15 lbs
 Packed: 5 pcs/bundle



IND-44-12

Hammered Edge
 Mtl: 1-9/16" x 5/16"
 H: 39-3/8"
 Weight: 38.5 lbs
 Packed: 5 pcs/bundle



IND-47-11

Hammered Edge
 Mtl: 9/16" Sq. Bar
 H: 35-1/2"
 Weight: 15.5 lbs
 Packed: 5 pcs/bundle

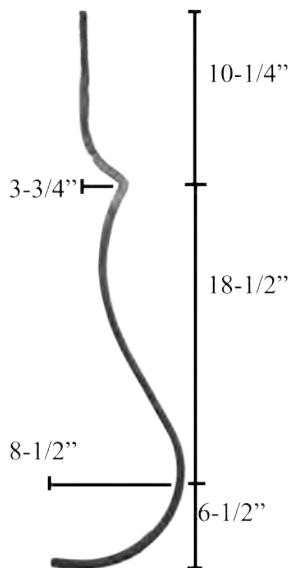

IND-70-D-5

Mtl: 9/16" Sq. Bar
 H: 35-7/16"
 Weight: 17 lbs
 Packed: 5 pcs/bundle



IND-47-7

Hammered Edge
 Mtl: 9/16" Sq.
 H: 35-7/16"
 Weight: 15 lbs
 Packed: 5 pcs/bundle



47-10 depicted.

TUBING SCROLLS



IND-90-T1

Fishtail Style Scroll
Mtl: 3/4" Tubing
H: 8-1/4"
W: 5-1/8"



IND-90-T5

Fishtail Style Scroll
Mtl: 3/4" Tubing
H: 26-5/8"
W: 11-3/8"



IND-90-T2

Fishtail Style Scroll
Mtl: 3/4" Tubing
H: 10-7/8"
W: 5-1/4"



IND-90-T6

Fishtail Style Scroll
Mtl: 3/4" Tubing
H: 30"
W: 11"



IND-90-T3

Fishtail Style Scroll
Mtl: 3/4" Tubing
H: 19-1/2"
W: 9-3/4"



IND-90-T4

Fishtail Style Scroll
Mtl: 3/4" Tubing
H: 19-1/2"
W: 9-3/4"



IND-90-T7

Fishtail Style Scroll
Mtl: 3/4" Tubing
H: 29"
W: 9-3/4"

SNAP-ON SCROLLS

IND-35-1C

Mtl: 1/2" x 1/4"
 H: 8-1/16"
 W: 17-1/2"
 Weight: 27 lbs./bundle
 Packed: 10 pcs/bundle



IND-37-3C

Mtl: 1/2" x 1/4"
 H: 3-3/4"
 W: 3-3/4"
 Weight: 24 lbs./bundle
 Packed: 40 pcs/box



IND-35-2C

Mtl: 1/2" x 1/4"
 H: 13-1/2"
 W: 8"
 Weight: 21 lbs./bundle
 Packed: 10 pcs/bundle

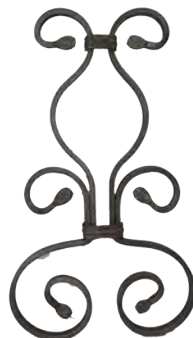

IND-37-4C

Mtl: 1/2" x 1/4"
 H: 6-1/2"
 W: 5-1/4"
 Weight: 34 lbs./bundle
 Packed: 40 pcs/bundle



IND-36-1C

Mtl: 1/2" x 1/4"
 H: 10"
 W: 8-5/8"
 Weight: 17 lbs./bundle
 Packed: 10 pcs/bundle



IND-36-2C

Mtl: 1/2" x 1/4"
 H: 15"
 W: 9"
 Weight: 28 lbs./bundle
 Packed: 10 pcs/bundle



36-1C and 36-2C depicted.

FISH TAIL SCROLLS

IND-80-A-1C

Mtl: 1/2" x 1/4"
H: 10-5/8"
W: 4-1/4"
Weight: 60 lbs./bundle
Packed: 80 pcs/bundle



IND-80-A-11C

Mtl: 1/2" x 1/4"
H: 5-7/8"
W: 2-1/2"
Weight: 40 lbs./bundle
Packed: 100 pcs/bundle



IND-80-A-3C

Mtl: 1/2" x 1/4"
H: 4-1/4"
W: 2-1/4"
Weight: 30 lbs./bundle
Packed: 100 pcs/bundle



IND-80-A-12C

Mtl: 1/2" x 1/4"
H: 7-1/2"
W: 2-3/4"
Weight: 50 lbs./bundle
Packed: 100 pcs/bundle



IND-80-A-9C

Mtl: 1/2" x 1/4"
H: 4-1/8"
W: 2-3/4"
Weight: 40 lbs./bundle
Packed: 100 pcs/bundle



IND-80-A-13C

Mtl: 1/2" x 1/4"
H: 13"
W: 5"
Weight: 50 lbs./bundle
Packed: 50 pcs/bundle



IND-80-A-10C

Mtl: 1/2" x 1/4"
H: 5-1/2"
W: 3-3/4"
Weight: 40 lbs./bundle
Packed: 100 pcs/bundle



IND-80-A-15C

Mtl: 1/2" x 1/4"
H: 15"
W: 5"
Weight: 45 lbs./bundle
Packed: 40 pcs/bundle



FISH TAIL SCROLLS

IND-80-A-17C

Mtl: 1/2" x 1/4"
H: 17"
W: 7"
Weight: 42 lbs./bundle
Packed: 30 pcs/bundle



IND-80-A-30C

Mtl: 1/2" x 1/4"
H: 10-1/2"
W: 3"
Weight: 39 lbs./bundle
Packed: 50 pcs/bundle



IND-80-A-22C

Mtl: 1/2" x 1/4"
H: 8-1/2"
W: 4"
Weight: 45 lbs./bundle
Packed: 50 pcs/bundle



IND-80-A-33C

Mtl: 1/2" x 1/4"
H: 11"
W: 6-1/2"
Weight: 42 lbs./bundle
Packed: 30 pcs/bundle



IND-80-A-23C

Mtl: 1/2" x 1/4"
H: 10-1/2"
W: 4-1/2"
Weight: 50 lbs./bundle
Packed: 50 pcs/bundle



IND-84-7C

Mtl: 3/4" x 1/4"
H: 8-7/8"
W: 5-7/8"
Weight: 48 lbs./bundle
Packed: 30 pcs/bundle



IND-80-A-24C

Mtl: 1/2" x 1/4"
H: 17"
W: 6-1/2"
Weight: 45 lbs./bundle
Packed: 30 pcs/bundle



“Different scrolls can be combined to create a custom and unique aesthetic.”

SCROLLS WITH LEAVES



IND-61121

Mtl: 1/2" x 1/4"
 H: 16-1/2"
 W: 8-1/2"
 Weight: 25 lbs/bundle
 Packed: 10 pcs/bundle



IND-61122

Mtl: 1/2" x 1/4"
 H: 16-1/2"
 W: 8-1/2"
 Weight: 25 lbs/box
 Packed: 10 pcs/bundle



IND-61135

Mtl: 1/2" x 1/4"
 H: 30"
 W: 12-1/2"
 Weight: 17.5 lbs/bundle
 Packed: 5 pcs/bundle



IND-61136

Mtl: 1/2" x 1/4"
 H: 30"
 W: 12-1/2"
 Weight: 17.5 lbs/box
 Packed: 5 pcs/bundle



IND-61157

Mtl: 1/2" x 1/4"
 H: 5"
 W: 10-1/4"
 Weight: 5 lbs/bundle
 Packed: 5 pcs/bundle



IND-61158

Mtl: 1/2" x 1/4"
 H: 5"
 W: 10-1/4"
 Weight: 5 lbs/bundle
 Packed: 5 pcs/bundle



IND-93-4C

Mtl: 1/2" x 1/4"
 H: 13-3/4"
 W: 9"
 Weight: 25 lbs/box
 Packed: 20 pcs/bundle



IND-94-3C

Mtl: 1/2" x 1/4"
 H: 7-7/8"
 W: 5-7/8"
 Weight: 25 lbs/box
 Packed: 20 pcs/bundle

TIGHT CURL SCROLLS (HAMMERED)

IND-62001

Mtl: 5/16" x 5/8"
H: 5"
W: 3"
Weight: 66 lbs/box
Packed: 100 pcs/box



IND-62006

Mtl: 5/16" x 5/8"
H: 11-1/2"
W: 4-7/8"
Weight: 29 lbs/box
Packed: 20 pcs/box



IND-62002

Mtl: 5/16" x 5/8"
H: 9"
W: 6"
Weight: 37 lbs/box
Packed: 25 pcs/box



IND-62007

Mtl: 5/16" x 5/8"
H: 11-1/2"
W: 5"
Weight: 68 lbs/box
Packed: 40 pcs/box



IND-62003

Mtl: 5/16" x 5/8"
H: 4-1/2"
W: 2-3/8"
Weight: 66 lbs/box
Packed: 100 pcs/box



IND-62008

Mtl: 5/16" x 5/8"
H: 5"
W: 14"
Packed: 40 pcs/bundle
Weight: 48 lbs/bundle



IND-62004

Mtl: 5/16" x 5/8"
H: 7-1/4"
W: 3-1/2"
Weight: 53 lbs/box
Packed: 50 pcs/box



IND-62005

Mtl: 5/16" x 5/8"
H: 10-1/2"
W: 4-1/2"
Weight: 36 lbs/box
Packed: 20 pcs/box



IND-64022

Smooth
Mtl: 5/16" x 5/8"
H: 14-1/2"
W: 4"
Weight: 37.5 lbs/box
Packed: 25 pcs/box

TIGHT CURL SCROLLS (EDGE GROOVED)



IND-61001

Mtl: 5/16" x 5/8"
H: 3-1/8"
W: 5-1/8"
Weight: 70 lbs./box
Packed 80 pcs/box



IND-61005

Mtl: 5/16" x 5/8"
H: 10-3/8"
W: 4-1/2"
Weight: 35 lbs./box
Packed 20 pcs/box



IND-61002

Mtl: 5/16" x 5/8"
H: 8-7/8"
W: 5-7/8"
Weight: 37 lbs./box
Packed 25 pcs/box



IND-61006

Mtl: 5/16" x 5/8"
H: 8-5/8"
W: 4-3/4"
Weight: 38 lbs./box
Packed 30 pcs/box



IND-61003

Mtl: 5/16" x 5/8"
H: 4-1/2"
W: 2-3/8"
Weight: 65 lbs./box
Packed 100 pcs/box



IND-61007

Mtl: 5/16" x 5/8"
H: 11-7/16"
W: 4-3/4"
Weight: 29 lbs./box
Packed 20 pcs/box



IND-61004

Mtl: 5/16" x 5/8"
H: 7"
W: 3-9/16"
Weight: 52 lbs./box
Packed 50 pcs/box



IND-61008

Mtl: 5/16" x 5/8"
H: 14-1/4"
W: 4-3/4"
Weight: 68 lbs./box
Packed 40 pcs/box

SCROLLS WITH LEAVES (EDGE GROOVED)



IND-61034

Mtl: 5/16" x 5/8"
 H: 12-1/2"
 W: 9-1/2"
 Weight: 2 lbs.
 Packed 25 pcs/box



IND-61035

Mtl: 5/16" x 5/8"
 H: 12-1/2"
 W: 9-1/2"
 Weight: 2 lbs.
 Packed 25 pcs/box



IND-61039

Mtl: 5/16" x 5/8"
 H: 15-3/4"
 W: 9-1/2"
 Weight: 2.8 lbs.
 Packed 20 pcs/box



IND-61040

Mtl: 5/16" x 5/8"
 H: 15-3/4"
 W: 9-1/2"
 Weight: 2.8 lbs.
 Packed 20 pcs/box



IND-61041

Mtl: 5/16" x 5/8"
 H: 12-1/2"
 W: 7-1/8"
 Weight: 2.1 lbs.
 Packed 25 pcs/box



IND-61042

Mtl: 5/16" x 5/8"
 H: 12-1/2"
 W: 7-1/8"
 Weight: 2.1 lbs.
 Packed 25 pcs/box



IND-61048

Mtl: 5/16" x 5/8"
 H: 8-1/4"
 W: 5-1/2"
 Weight: 1.32 lbs./box
 Packed 40 pcs/box



IND-61049

Mtl: 5/16" x 5/8"
 H: 8-1/4"
 W: 5-1/2"
 Weight: 1.3 lbs./box
 Packed 40 pcs/box



IND-61051

Mtl: 5/16" x 5/8"
 H: 8-5/8"
 W: 5-3/4"
 Weight: 1.4 lbs./box
 Packed 40 pcs/box



IND-61052

Mtl: 5/16" x 5/8"
 H: 8-5/8"
 W: 5-3/4"
 Weight: 1.4 lbs./box
 Packed 40 pcs/box

ROUND BAR SCROLLS



IND-94-F-3C

Mtl: 1/2" Dia. Bar
H: 31-1/2"
W: 19-1/4"
Weight: 27 lbs./bundle
Packed 5 pcs/bundle



IND-94-F-4C

Mtl: 1/2" Dia. Bar
H: 31-1/2"
W: 19-1/4"
Weight: 27 lbs./bundle
Packed 5 pcs/bundle



IND-94-F-5C

Mtl: 1/2" Dia. Bar
H: 38-1/4"
W: 16-1/2"
Weight: 30 lbs./bundle
Packed 5 pcs/bundle



IND-94-F-6C

Mtl: 1/2" Dia. Bar
H: 38-1/4"
W: 16-1/2"
Weight: 30 lbs./bundle
Packed 5 pcs/bundle



IND-94-E-5C

Mtl: 1/2" Dia. Bar
H: 24-1/2"
W: 16-1/8"
Weight: 22 lbs./bundle
Packed 5 pcs/bundle



IND-94-E-6C

Mtl: 1/2" Dia. Bar
H: 24-1/2"
W: 16-1/8"
Weight: 22 lbs./bundle
Packed 5 pcs/bundle

ROUND BAR SCROLLS



IND-94-C-11C

Mtl: 1/2" Dia. Bar
H: 14-1/2"
W: 13"
Weight: 35 lbs./bundle
Packed: 10 pcs/bundle



IND-94-C-12C

Mtl: 1/2" Dia. Bar
H: 14-1/2"
W: 13"
Weight: 35 lbs./bundle
Packed: 10 pcs/bundle



IND-94-E-1C

Mtl: 1/2" Dia. Bar
H: 17-1/4"
W: 19-1/4"
Weight: 24 lbs./bundl-
Packed: 10 pcs/bundle



IND-94-E-2C

Mtl: 1/2" Dia. Bar
H: 17-1/4"
W: 19-1/4"
Weight: 24 lbs./bundle
Packed: 10 pcs/bundle



IND-94-E-3C

Mtl: 1/2" Dia. Bar
H: 21-1/4"
W: 12-1/4"
Weight: 15 lbs./bundle
Packed: 5 pcs/bundle



IND-94-E-4C

Mtl: 1/2" Dia. Bar
H: 21-1/4"
W: 12-1/4"
Weight: 15 lbs./bundle
Packed: 5 pcs/bundle

ROSETTE DESIGNS



IND-15-1C

Mtl: 9/32" x 5/8"
 Size: 10-3/8" Dia.
 Weight: 21 lbs.
 Packed: 10 pcs/box

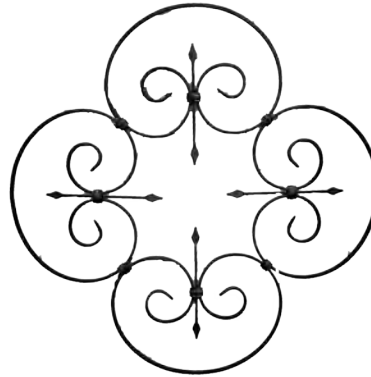

IND-24-3C

Hammered Edge
 Mtl: 3/8" x 1/4"
 Size: 23-5/8" Dia.
 Weight: 13 lbs./box
 Packed 5 pcs/box

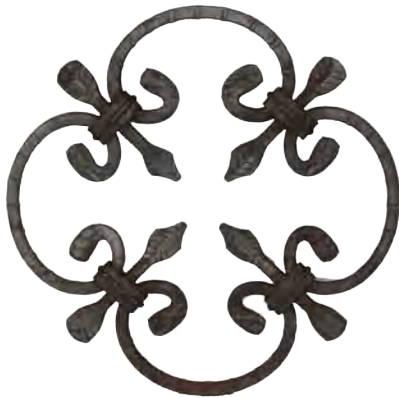

IND-17-1C

Mtl: 5/16" Sq.
 Size: 10" Dia.
 Weight: 20 lbs.
 Packed: 10 pcs/box



IND-26-C-1C

Mtl: 1/2" Sq.
 H: 19-1/2"
 W: 15-1/2"
 Weight: 10 lbs.
 Packed Each



IND-17-2C

Mtl: 5/16" Sq.
 Size: 10" Dia.
 Weight: 10 lbs.
 Packed 20 pcs/box



IND-1013-1C

Mtl: 1/2" Dia. Bar
 H: 11-1/2" Dia.
 Weight: 6 lbs.
 Packed Each

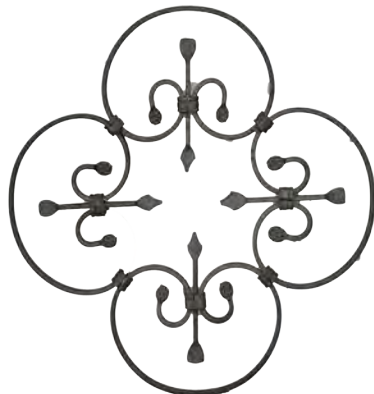

IND-24-2C

Mtl: 3/8" x 1/4"
 Size: 15" Dia.
 Weight: 16 lbs./box
 Packed 5 pcs/box



IND-1013-2C

Mtl: 1/2" Sq.
 Size: 11-1/2" Dia.
 Weight: 7 lbs.
 Packed Each

DECORATIVE PANELS

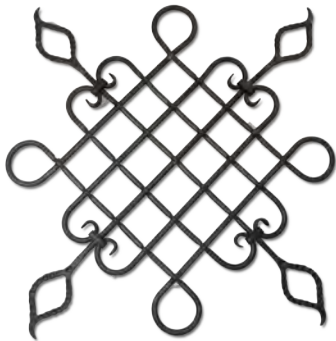

IND-13026

Mtl: 9/16" Dia. Round
H: 32"
W: 32"
Weight: 12 lbs.
Packed Each



IND-13049

Grooved Edge
Mtl: 5/16" x 5/8" Flat bar
H: 28-1/8"
W: 25"
Weight: 21 lbs.
Packed each



IND-13027

Mtl: 9/16" Dia. Round
H: 16-7/8"
W: 16-7/8"
Weight: 7 lbs.
Packed each



IND-13054

Mtl: 5/16" x 5/8" Flat bar
H: 18-3/4"
W: 18-3/4"
Weight: 8 lbs.
Packed: 20 pcs/box
Packed Each

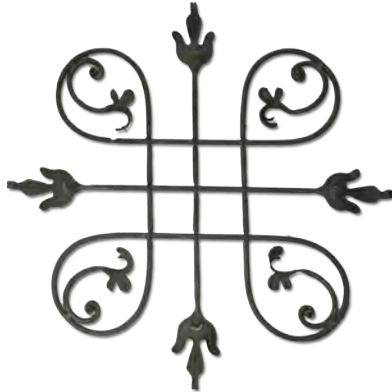

IND-13028

Mtl: 9/16" Dia. Round
H: 30-5/8"
W: 30-5/8"
Weight: 13 lbs.
Packed each



IND-13124

Grooved Edge
Mtl: 5/16" x 5/8" Flat bar
H: 34-3/4"
W: 12-1/4"
Weight: 12 lbs.
Packed each

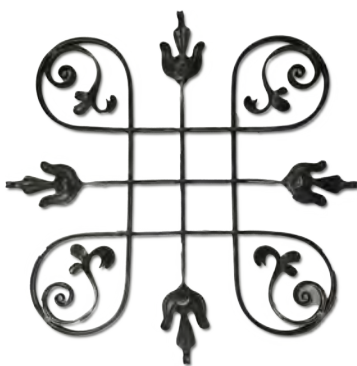

IND-13029

Grooved Edge
Mtl: 5/16" x 5/8" Bar
H: 28-3/8"
W: 28-3/8"
Weight: 12.35 lbs.
Packed Each



IND-13125

Grooved Edge
Mtl: 5/16" x 5/8" Flat bar
H: 34-3/4"
W: 12-1/4"
Weight: 12 lbs.
Packed each

DECORATIVE PANELS



IND-21025

Size: 24" x 30-3/8"
Weight: 20 lbs.
Packed: Each



IND-51011

H: 16"
W: 16-1/2"
Weight: 10 lbs.
Packed: Each



IND-21027

Size: 14" x 19-1/4"
Weight: 8 lbs.
Packed: Each



IND-51012

H: 39-1/2"
W: 19"
Weight: 28 lbs.
Packed: Each



IND-51006

H: 8"
W: 5-1/8"
Size: 10" Dia.
Weight: 3 lbs./bundle
Packed 5 pcs/bundle



IND-51020

H: 15-3/4"
W: 15"
Weight: 9 lbs.
Packed: Each



IND-51007

H: 11-3/4"
W: 7"
Size: 10" Dia.
Weight: 3 lbs./bundle
Packed 5 pcs/bundle



IND-51021

H: 15-3/4"
W: 16"
Weight: 10 lbs.
Packed: Each

DECORATIVE PANELS



IND-51030

H: 17-1/4"
W: 19"
Weight: 6.4 lbs.
Packed: Each



IND-51201

H: 13-1/2"
W: 42"
Weight: 10 lbs.
Packed: Each



IND-51202

H: 14-1/4"
W: 39-3/4"
Weight: 10 lbs.
Packed: Each



IND-51207

H: 11-1/4"
W: 23-5/8"
Weight: 10 lbs.
Packed: Each



IND-51208

H: 11-1/4"
W: 23-5/8"
Weight: 10 lbs.
Packed: Each

DECORATIVE PANELS



IND-51209

Grooved Edge
Mtl: 5/16" x 5/8"
H: 11-1/2"
W: 35-1/2"
Weight: 8 lbs.
Packed: Each



IND-51214

Mtl: 1/4" x 3/4"
H: 9-1/4"
W: 29-1/2"
Weight: 8 lbs.
Packed: Each



IND-51216

Mtl: 1/4" x 3/4"
H: 12-3/4"
W: 43-5/8"
Weight: 21 lbs.
Packed: Each



IND-678-1C

Mtl: 1/2" Dia. Hammered
H: 3-1/8"
W: 23"
Weight: 3 lbs.
Packed: 10pcs/bundle



IND-678-2C

Grooved Edge
Mtl: 5/16" x 5/8"
H: 3-1/8"
W: 23"
Weight: 3 lbs.
Packed: 10pcs/bundle

DECORATIVE PANELS



IND-13118

Hammered
Mtl: 1/2" Square
H: 31-7/8"
W: 12-1/4"
Weight: 12 lbs.
Packed: 5pcs/bundle



IND-62-1C

Mtl: 3/4" x 1/4"
H: 28-3/8"
W: 9-1/4"
Weight: 10 lbs.
Packed: 5 pcs/bundle

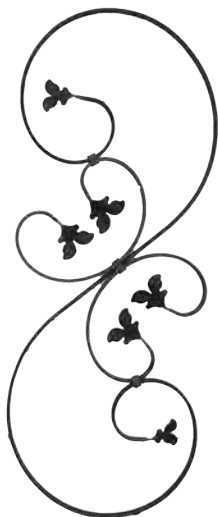

IND-13120

Mtl: 1/2" x 1/4"
H: 34-1/4"
W: 13-1/2"
Weight: 11 lbs.
Packed: 5 pcs/bundle



IND-13065

Matches IND-12065
Mtl: 1/4" x 1/2"
H: 16"
W: 6"
Weight: 5 lbs.
Packed: 5 pcs/bundle



IND-13113

Mtl: 5/16" x 3/4"
H: 34-3/4"
W: 13-3/4"
Weight: 12 lbs.
Packed: 5 pcs/bundle

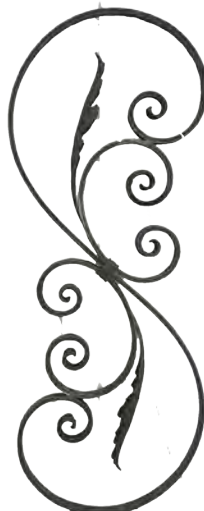

IND-13114

Mtl: 5/16" x 3/4"
H: 34-3/4"
W: 13-3/4"
Weight: 10 lbs.
Packed: 5 pcs/bundle

FORGED LEAVES



IND-21011

Crown
H: 7-1/2"
W: 4-1/4"
Weight: 3 lbs.
Packed: 25 pcs/box
5 pcs/pack



IND-30014

Leaf
H: 3-1/2"
W: 1-1/2"
Weight: 0.10 lbs.
Packed: 250 pcs/box
10 pcs/pack

Decorative steel leaves and flowers are great for finishing touches. Choose from our hand selected steel leaves that come in all shapes and sizes to match the decor of the surrounding area.



IND-30021

Leaf
H: 4-7/8"
W: 2"
Weight: 0.10 lbs.
Packed: 130 pcs/box
10 pcs/pack



IND-30022

Leaf
H: 3-7/8"
W: 2-1/8"
Weight: 0.25 lbs.
Packed: 130 pcs/box
10 pcs/pack



IND-30013

Leaf
H: 3-1/2"
W: 1-1/2"
Weight: 0.10 lbs.
Packed: 250 pcs/box
10 pcs/pack



IND-30024

Leaf
H: 3-3/4"
W: 3"
Weight: 0.4 lbs.
Packed: 200 pcs/box
10 pcs/pack

FORGED LEAVES



IND-30026

Leaf
 H: 4-3/4"
 W: 2-3/8"
 Weight: 0.25 lbs.
 Packed: 100 pcs/box
 10 pcs/pack



IND-30031

Flower
 H: 5-1/2"
 W: 3-1/8"
 Weight: 0.70 lbs.
 Packed: 50 pcs/box
 10 pcs/pack



IND-30028

Leaf
 H: 5-5/8"
 W: 3-1/2"
 Weight: 0.44 lbs.
 Packed: 100 pcs/box
 10 pcs/pack



IND-30033

Leaf
 H: 11"
 W: 3-1/2"
 Weight: 0.60 lbs.
 Packed: 50 pcs/box



IND-30029

Flower
 H: 4-3/4"
 Weight: 1 lbs.
 Packed: 30 pcs/box
 10 pcs/pack



IND-30034

Leaf
 H: 11"
 W: 3-1/2"
 Weight: 0.60 lbs.
 Packed: 50 pcs/box



IND-30030

Flower
 Size: 3-1/4" Dia. Flower
 H: 12-1/4"
 Weight: 0.60 lbs.
 Packed: 50 pcs/box
 10 pcs/pack



IND-30035

Leaf
 H: 6"
 W: 5-7/8"
 Weight: 0.80 lbs.
 Packed: 40 pcs/box

FORGED LEAVES



IND-30036

Leaf
H: 6"
W: 5-7/8"
Weight: 0.80 lbs.
Packed: 40 pcs/box
10 pcs/pack



IND-30039

Leaf
H: 12"
W: 6"
Weight: 1.40 lbs.
Packed: 30 pcs/box
10 pcs/pack



IND-30037

Leaf
H: 4-3/4"
W: 6"
Weight: 0.60 lbs.
Packed: 40 pcs/box
10 pcs/pack



IND-30040

Leaf
H: 12"
W: 6"
Weight: 1.40 lbs.
Packed: 30 pcs/box
10 pcs/pack



IND-30038

Leaf
H: 4-3/4"
W: 6"
Weight: 0.60 lbs.
Packed: 40 pcs/box
10 pcs/pack

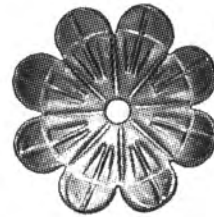

IND-32179

Size: 2" Dia. 1/4" Hole
Mtl: 10 Gauge steel
Hole: 1/4"
Weight: 0.10 lbs.
Packed: 100 pcs/box

FORGED GRAPES



Shown 33017

“Grapes are one of the earliest cultivated crops known to modern society and have come to symbolize abundance, fertility, and prosperity.”



IND-33016

Grapes
H: 4-1/8”
W: 2-3/4”
Weight: 1 lbs.
Packed: 5 pcs/box



IND-33018

Grapes W/ Cast Steel Leaf
H: 7-1/8”
W: 5-7/8”
Grape Cluster: 5” x 3”
Weight: 3 lbs.
Packed: 5 pcs/box



IND-33017

Grapes
H: 7-1/8”
W: 5-7/8”
Grape Cluster: 4” x 3”
Weight: 2 lbs.
Packed: 5 pcs/box



IND-33019

Grapes W/ Forged Leaf
H: 6-5/8”
W: 5-1/2”
Weight: 3 lbs.
Packed: 5 pcs/box

CAST STEEL ELEMENTS



IND-120-1C

Base Dia.: 1-9/16"
H: 9-3/4"
W: 3-1/4"
Weight: 42 lbs.
Packed: 30 pcs/box



IND-124-2C

Base Dia.: 19/32"
H: 5-3/4"
W: 2-3/4"
Weight: 21 lbs.
Packed: 30 pcs/box



IND-120-2C

Base Dia.: 1-3/8"
H: 8"
W: 2-3/8"
Weight: 33 lbs.
Packed: 30 pcs/box



IND-125-1C

Base Dia.: 1-3/8"
H: 5"
W: 2-1/4"
Weight: 18 lbs.
Packed: 30 pcs/box



IND-122-A-1C

Base Dia.: 1-3/8"
H: 7-7/8"
W: 3"
Weight: 30 lbs.
Packed: 30 pcs/box



124-2C depicted

CAST STEEL FLORAL ELEMENTS

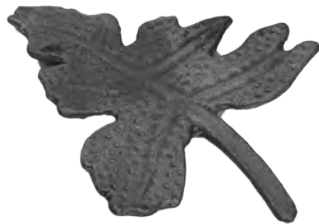

IND-140-H-3C

Leaf
H: 5"
W: 3-1/2"
Weight: 0.25 lbs.
Packed: 100 pcs/box
10 pcs/pack



IND-661-3C

Leaf
H: 5-7/8"
W: 4-1/2"
Weight: 0.7 lbs.
Packed: 40 pcs/box



IND-661-1C

Leaf
H: 5-7/8"
W: 5"
Weight: 0.6 lbs.
Packed: 40 pcs/box



IND-31040

Leaf
H: 7-3/4"
W: 2-1/2"
Weight: 0.65 lbs.
Packed: 60 pcs/box



IND-661-2C

Leaf
H: 6-1/8"
W: 5-1/2"
Weight: 0.6 lbs.
Packed: 40 pcs/box



IND-663-1C

Leaf
H: 5-1/2"
W: 4-1/4"
Weight: 1 lbs.
Packed: 100 pcs/box



IND-661-4C

Leaf
H: 5"
W: 3"
Weight: 0.3 lbs.
Packed: 50 pcs/box



IND-663-2C

Leaf
H: 5-1/2"
W: 4-1/4"
Weight: 1 lbs.
Packed: 100 pcs/box

CAST STEEL FLORAL ELEMENTS



IND-663-3C

Leaf
H: 3"
W: 3-1/2"
Weight: 12 lbs.
Packed: 40 pcs/box



IND-663-7C

Leaf
H: 3"
W: 3-1/2"
Weight: 12 lbs.
Packed: 40 pcs/box



IND-663-4C

Leaf
H: 3"
W: 3-1/2"
Weight: 12 lbs.
Packed: 40 pcs/box



IND-663-8C

Leaf
H: 3"
W: 3-1/2"
Weight: 12 lbs.
Packed: 40 pcs/box



IND-663-5C

Leaf
H: 5"
W: 5-1/2"
Weight: 16 lbs.
Packed: 40 pcs/box



IND-4140-L

Leaf
H: 5"
W: 5-1/2"
Weight: 16 lbs.
Packed: 40 pcs/box



IND-663-6C

Leaf
H: 5"
W: 5-1/2"
Weight: 16 lbs.
Packed: 40 pcs/box



IND-4140-R

Leaf
H: 5"
W: 5-1/2"
Weight: 16 lbs.
Packed: 40 pcs/box

STAMPED FLORAL ELEMENTS



IND-116-A-3C

Mtl: 1/8"
 Dia.: 3-3/4"
 Hole: 5/8"
 W: 3-1/2"
 Weight: 0.4 lbs.
 Packed: 100 pcs/box
 10 pcs/pack



IND-136-2C

Mtl: 1/8"
 H: 4-5/16"
 W: 1-1/2"
 Weight: 0.2 lbs.
 Packed: 200 pcs/box
 10 pcs/pack



IND-116-A-4C

Mtl: 1/8"
 Dia.: 2-1/4"
 Hole: 5/8"
 Weight: 0.20 lbs.
 Packed: 100 pcs/box
 10 pcs/pack



IND-136-3C

Mtl: 1/8"
 H: 2-1/2"
 W: 2-3/4"
 Weight: 0.2 lbs.
 Packed: 200 pcs/box
 10 pcs/pack



IND-116-A-5C

Mtl: 1/8"
 Dia.: 3-3/4"
 Weight: 0.6 lbs.
 Packed: 100 pcs/box
 10 pcs/pack



IND-136-4C

Mtl: 1/8"
 H: 2-1/2"
 W: 2-3/4"
 Weight: 0.2 lbs.
 Packed: 200 pcs/box
 10 pcs/pack



IND-136-1C

Mtl: 1/8"
 H: 4-5/16"
 W: 1-1/2"
 Weight: 0.2 lbs.
 Packed: 200 pcs/box
 10 pcs/pack



116-A-4C depicted.

STAMPED FLORAL ELEMENTS



IND-136-10C

Mtl: 1/8"
 H: 6-1/4"
 W: 2-1/8"
 Weight: 0.6 lbs.
 Packed: 200 pcs/box
 10 pcs/pack



IND-136-17C

Mtl: 5/16"
 H: 8-7/8"
 W: 1"
 Weight: 0.28 lbs.
 Packed: 100 pcs/box



IND-136-11C

Mtl: 1/8"
 H: 6-1/4"
 W: 2-1/8"
 Weight: 0.6 lbs.
 Packed: 200 pcs/box
 10 pcs/pack



IND-136-18C

Mtl: 5/64"
 H: 11-1/4"
 W: 1-5/8"
 Weight: 0.30 lbs.
 Packed: 100 pcs/box



IND-136-15C

Mtl: 1/8"
 H: 4-3/4"
 W: 2-3/4"
 Weight: 0.2 lbs.
 Packed: 250 pcs/box
 10 pcs/pack



IND-136-16C

Mtl: 1/8"
 H: 4-3/4"
 W: 2-3/4"
 Weight: 0.2 lbs.
 Packed: 250 pcs/box
 10 pcs/pack



13125 & 116-A-5C depicted.

PRESSED SHEET METAL ELEMENTS



IND-136-5C

Mtl: .02"
Dia.: 2-9/16"
H: 1-1/4"
Weight: 0.05 lbs.
Packed: 200 pcs/box
10 pcs/box



IND-137-7C

Mtl: .02"
H: 5"
W: 2-3/8"
Weight: 0.05 lbs.
Packed: 400 pcs/box
20 pcs/box



IND-136-6C

Mtl: .02"
Dia.: 2-1/8"
H: 1-5/8"
Weight: 0.05 lbs.
Packed: 200 pcs/box
10 pcs/box



IND-137-8C

Mtl: .02"
H: 3-1/2"
W: 2"
Weight: 0.05 lbs.
Packed: 400 pcs/box
20 pcs/box



IND-136-7C

Mtl: .02"
Dia.: 1-1/2"
H: 1-1/2"
Weight: 0.05 lbs.
Packed: 200 pcs/box
10 pcs/box



IND-136-8C

Mtl: .02"
Dia.: 1-5/8"
H: 3/4"
Weight: 0.05 lbs.
Packed: 250 pcs/box
10 pcs/box

"The difference between something good and something great is attention to detail. Floral elements instantly add intricate elegance to any design."

PRESSED SHEET METAL ELEMENTS



IND-137-9C

Mtl: .02"
H: 2-1/2"
W: 4-1/4"
Weight: 0.05 lbs.
Packed: 400 pcs/box
20 pcs/pack



IND-138-11C

Mtl: .02"
H: 2-3/4"
W: 3"
Weight: 0.03 lbs.
Packed: 300 pcs/box
20 pcs/pack



IND-137-10C

Mtl: .02"
H: 5"
W: 6-7/8"
Weight: 0.01 lbs.
Packed: 200 pcs/box
20 pcs/pack



IND-138-12C

Mtl: .02"
H: 4-1/8"
W: 3-3/4"
Weight: 0.06 lbs.
Packed: 200 pcs/box
20 pcs/pack



IND-138-3C

Mtl: 1/8"
H: 1/2"
W: 3-1/8"
Weight: 0.15 lbs.
Packed: 250 pcs/box
10 pcs/pack



IND-138-13C

Mtl: .02"
H: 7-5/8"
W: 7-1/2"
Weight: 0.07 lbs.
Packed: 200 pcs/box
20 pcs/pack



IND-138-4C

Mtl: 5/64"
H: 3/8"
W: 3-1/2"
Weight: 0.01 lbs.
Packed: 200 pcs/box
10 pcs/pack



IND-139-1C

Mtl: .02"
H: 2-1/2"
W: 1-1/8"
Weight: 0.01 lbs.
Packed: 400 pcs/box
20 pcs/pack



IND-138-10C

Mtl: .0197"
H: 3-3/8"
W: 1-3/4"
Weight: 0.02 lbs.
Packed: 250 pcs/box
10 pcs/pack

PRESSED SHEET METAL ELEMENTS



IND-139-3C

Mtl: .02"
H: 3-1/2"
W: 1-1/4"
Weight: 0.04 lbs.
Packed: 200 pcs/box
10 pcs/pack



IND-604-11C

Mtl: 1/16"
H: 1-7/8"
W: 1-3/8"
Weight: 0.01 lbs.
Packed: 200 pcs/box
20 pcs/pack
Match for 604/6C &
604/7C



IND-139-4C

Mtl: .02"
H: 7-7/8"
W: 2-1/2"
Weight: 0.07 lbs.
Packed: 200 pcs/box
20 pcs/pack



IND-604-12C

Mtl: 1/16"
H: 2"
W: 1-3/8"
Weight: 0.01 lbs.
Packed: 200 pcs/box
20 pcs/pack
Match for 604/6C and
604/7C



IND-139-5C

Mtl: .02"
H: 4-1/8"
W: 1-1/2"
Weight: 0.04 lbs.
Packed: 500 pcs/box
20 pcs/pack



IND-140-1C

Mtl: .02"
H: 2-1/8"
W: 3/4"
Weight: 0.15 lbs.
Packed: 250 pcs/box
10 pcs/pack



IND-139-6C

Mtl: 5/64"
H: 2-3/4"
W: 1-1/8"
Weight: 0.03 lbs.
Packed: 400 pcs/box
20 pcs/pack



IND-140-2C

Mtl: .02"
H: 2-1/2"
W: 1-5/32"
Weight: 0.08 lbs.
Packed: 500 pcs/box
20 pcs/pack

PRESSED SHEET METAL ELEMENTS



IND-140-3C

Mtl: .02"
 H: 3-1/8"
 W: 1-1/2"
 Weight: 0.06 lbs.
 Packed: 300 pcs/box
 20 pcs/pack



IND-140-8C

Mtl: .02"
 H: 3/8"
 Dia.: 1-1/2"
 Weight: 0.01 lbs.
 Packed: 200 pcs/box
 20 pcs/pack



IND-140-5C

Mtl: .02"
 H: 2-3/4"
 W: 2-3/4"
 Weight: 0.01 lbs.
 Packed: 200 pcs/box
 10 pcs/pack



IND-SS1101

Mtl: .02"
 H: 7-1/4"
 W: 2-1/4"
 Weight: 0.01 lbs.
 Packed: 200 pcs/box
 20 pcs/pack



IND-140-6C

Mtl: .02"
 H: 5/8"
 Dia.: 3/4"
 Weight: 0.01 lbs.
 Packed: 200 pcs/box
 10 pcs/pack



IND-SS1102

Mtl: .02"
 H: 9"
 W: 2-5/8"
 Weight: 0.01 lbs.
 Packed: 200 pcs/box
 20 pcs/pack



IND-140-7C

Mtl: .02"
 H: 1/2"
 Dia.: 1"
 Weight: 0.01 lbs.
 Packed: 200 pcs/box
 20 pcs/pack



IND-SS1103

Mtl: .02"
 H: 11-1/2"
 W: 2-1/8"
 Weight: 0.01 lbs.
 Packed: 200 pcs/box
 20 pcs/pack

SPHERE AND BASKET

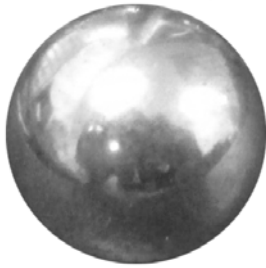

STAMPED SHERE

Item#	Dia.	Wgt	Pk
IND-116F-1C	3/4"	60 lbs.	500/bx
IND-116F-2C	1"	30 lbs.	200/bx
IND-116F-3C	1-3/16"	30 lbs.	100/bx
IND-116F-4C	1-9/16"	45 lbs.	75/bx
IND-116F-5C	2"	65 lbs.	50/bx



FORGED SHERE

Item#	Dia.	Wgt	Pk
IND-117-2C	3/4"	50 lbs.	500/bx
IND-117-4C	1-1/4"	30 lbs.	100/bx
IND-117-5C	1-1/2"	25 lbs.	50/bx



BASKET

Item#	H	W	End	Wgt	Pk
IND-159-1C	3-9/16"	1-3/8"	5/16"	10 lbs.	100/bx
IND-159-3C	5"	2-3/8"	1/2"	35 lbs.	70/bx
IND-159-4C	5"	2-1/2"	9/16"	42 lbs.	60/bx
IND-159-5C	5-3/4"	2-9/16"	5/8"	36 lbs.	40/bx
IND-159-6C	6-1/2"	3-1/8"	3/4"	37.5 lbs.	25/bx
IND-159-7C	7"	3-3/4"	15/16"	54 lbs.	20/bx
IND-158B-7C	ROUND	2-3/4" dia.	1/4"	50 lbs.	100/bx

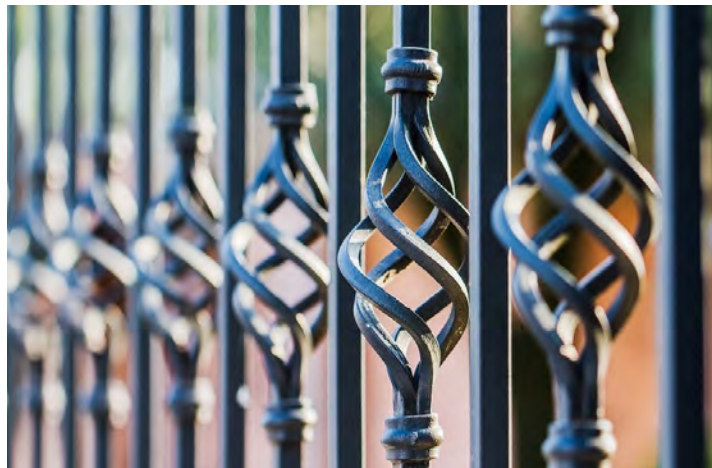

159/3C depicted

DECORATIVE FLAT BAR



IND-BT825M

H: 10" ft.
W: 1" x 5/16"
Weight: 10 lbs.
Packed: 10 pcs/bundle



IND-158-1C

Mtl: 9/16" x 5/32"
Weight: 42 lbs.
Packed: 22 pcs/bundle



IND-BT825F

H: 10 ft.
W: 1" x 5/16"
Weight: 10 lbs.
Packed: 10 pcs/bundle

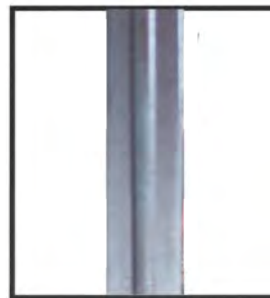

IND-158-3C

Mtl: 9/16" x 5/32"
W: 1" x 5/16"
Weight: 44 lbs.
Packed: 22 pcs/bundle

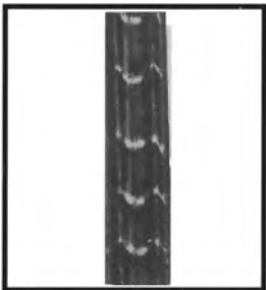

IND-BT1050H

H: 79"
W: 2" x 3/8"
Weight: 20 lbs.
Packed: 10 pcs/bundle

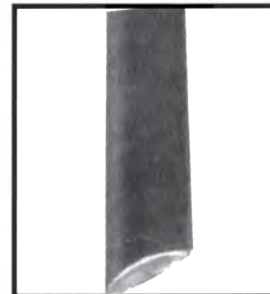

IND-158-6C

H: 10" ft.
W: 1" x 5/16"
Weight: 10 lbs.
Packed: 10 pcs/bundle



IND-114-8C

H: 10"
W: 1-1/2" x 5/16"
Weight: 16.5 lbs.
Packed: 10 pcs/bundle

DECORATIVE ROUND BAR



SQUARE HAMMERED BAR

Item#	Dia.	L	Wgt	Pk
IND-FT12A	1/2"	10 ft.	75 lbs.	10/bdl
IND-FT16A	5/8"	10 ft.	135 lbs.	10/bdl
IND-FT18A	3/4"	10 ft.	175 lbs.	5/bdl



HAMMERED ROUND BAR

Item#	Dia.	L	Wgt	Pk
IND-YT12A	1/2"	10 ft.	60 lbs.	10/bdl
IND-YT16A	5/8"	10 ft.	100 lbs.	10/bdl
IND-YT18A	3/4"	10 ft.	67.5 lbs.	5/bdl



VINEYARD BAR

Item#	Dia.	L	Wgt	Pk
IND-598-11	5/16"	10 ft.	25 lbs.	10/bdl
IND-598-13	1/2"	10 ft.	58 lbs.	10/bdl
IND-598-16	3/4"	10 ft.	64 lbs.	5/bdl



TREE BARK BAR

Item#	Dia.	L	Wgt	Pk
IND-599-1	5/16"	10 ft.	25 lbs.	10/bdl
IND-599-2	3/8"	10 ft.	40 lbs.	10/bdl
IND-599-3	1/2"	10 ft.	70 lbs.	10/bdl
IND-599-5	5/8"	10 ft.	55 lbs.	5/bdl

END PIECES FOR HANDRAILS



IND-126-1C

H: 11"
W: 15"
Weight: 3 lbs.
For Handrail 114-5C



IND-126-2C

H: 11"
W: 15"
Weight: 3 lbs.
For Handrail 114-8C



IND-126-3C

H: 11"
W: 15"
Weight: 3 lbs.
For Handrail 114-9C



IND-126-4C

H: 11"
W: 15"
Weight: 3 lbs.
For Handrail BT840D



IND-126-5C

H: 11"
W: 15"
Weight: 3 lbs.
For Handrail BT850E



IND-126-6C

H: 11"
W: 15"
Weight: 3 lbs.
For Handrail BT1850VF

HOT PIERCED BARS



IND-42-9

Mtl: 5/8" Sq. Bar
Dia.: 3-7/8"
Holes: 5/8"
17 holes
Weight: 8.5 lbs.

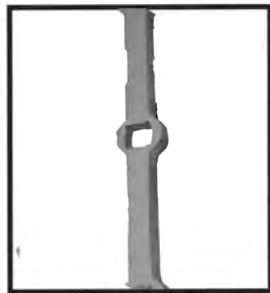

IND-42-10

Mtl: 5/8" Sq. Bar
Dia.: 6-1/4"
Holes: 3/4"
12 holes
Weight: 11 lbs.

END PIECES FOR HANDRAILS



IND-126-11C

H: 5"
W: 12"
Weight: 3 lbs.
For Handrail 114-5C



IND-126-12C

H: 5"
W: 12"
Weight: 3 lbs.
For Handrail 114-8C



IND-126-13C

H: 5"
W: 12"
Weight: 3 lbs.
For Handrail 114-9C



IND-126-14C

H: 5"
W: 12"
Weight: 3 lbs.
For Handrail BT840D



IND-126-15C

H: 5"
W: 12"
Weight: 3 lbs.
For Handrail BT850E



IND-126-16C

H: 5"
W: 12"
Weight: 3 lbs.
For Handrail BT1850VF

INDEX

Item	Page	Item	Page	Item	Page	Item	Page	Item	Page
AL-03023	31	AL-121D	35	AL-204BNBSH	28	AL-251-58D	35	AL-4RNT	36
AL-03038-12	21	AL-122	26	AL-204BNBST	28	AL-252-12	22	AL-5-12	22
AL-03038-58	21	AL-124	25	AL-21-12	25	AL-252-34	22	AL-552	27
AL-03038SH-12	21	AL-130	26	AL-21-34	25	AL-252-58	22	AL-560	26
AL-03039-12	21	AL-13-12	20	AL-215-12D	35	AL-258	24	AL-564	26
AL-03039-58	21	AL-134	28	AL-215-34D	35	AL-26-12	22	AL-5R	36
AL-03039SH-12	21	AL-135	28	AL-21-58	25	AL-26SH-12	22	AL-5RNT	36
AL-03068	21	AL-138	28	AL-216	31	AL-270	27	AL-61	29
AL-03068SH	21	AL-142	28	AL-217B-12D	35	AL-27-12	22	AL-62	29
AL-03068SHWT	21	AL-142D	36	AL-217B-34D	35	AL-275-12	22	AL-63	29
AL-03700	31	AL-143D	36	AL-217B-58D	35	AL-275-34	22	AL-709F	31
AL-1000L	27	AL-144D	36	AL-21SF-12	20	AL-275-58	22	AL-717	29
AL-1000R	27	AL-145D	36	AL-21SFSH-12	20	AL-2T-12	20	AL-718	29
AL-101	23	AL-146	28	AL-21SFSHNT-12	20	AL-2T-34	20	AL-762L	27
AL-102	23	AL-147D	36	AL-21SFSHNT-12B	20	AL-2T-34NT	20	AL-762R	27
AL-103-12	23	AL-148	25	AL-21SFSHNT-12W	20	AL-2T-58	20	AL-8-12	20
AL-103-58	23	AL-151	25	AL-224	28	AL-2TSH-12	20	AL-8-12NT	20
AL-105	23	AL-154	25	AL-23-12	20	AL-2TSH-12B	20	AL-8-34	20
AL-106	23	AL-156	24	AL-23-34	20	AL-2TSH-12W	20	AL-8-34NT	20
AL-107-12	20	AL-158	25	AL-23-58	20	AL-3702	28	AL-8-34SH	20
AL-107-34	20	AL-176	31	AL-238	31	AL-3703	28	AL-8-58	20
AL-107-58	20	AL-181	24	AL-23SH-12	20	AL-3705	28	AL-8SH-12	20
AL-109	24	AL-182	24	AL-244-12	21	AL-3706	28	AL-8SH-12B	20
AL-110	23	AL-183	24	AL-244-34	21	AL-3711	28	AL-8SH-12W	20
AL-113	23	AL-187-12	21	AL-244-58	21	AL-3712	28	AL-9Z	35
AL-115B	24	AL-187-34	21	AL-245-12	21	AL-3T-12	20	AL-B100	36
AL-117	31	AL-187-58	21	AL-245-34	21	AL-3T-34	20	AL-B112	36
AL-118D	35	AL-190S	24	AL-245-58	21	AL-3T-58	20	AL-B200	36
AL-119	26	AL-192-12	21	AL-245SH-12	21	AL-3TSH-12	20	AL-B212	36
AL-119D	35	AL-192-34	21	AL-247	27	AL-3TSH-12B	20	AL-B300	36
AL-120	26	AL-192-58	21	AL-251-12D	35	AL-3TSH-12W	20	AL-B34	36
AL-120D	35	AL-196-12	21	AL-251-1D	35	AL-442L	33	AL-BH3A	34
AL-12-12	20	AL-204BNB	33	AL-251-34D	35	AL-4R	36	AL-BH93R	34

INDEX

Item	Page	Item	Page	Item	Page	Item	Page	Item	Page
AL-CE1-12	22	CL-100	18	CL-7009	3	CL-853H-58	4	CL-BH3HRB	13
AL-M1	32	CL-145	15	CL-7056	12	CL-853Y-34	4	CL-HK8127	10
AL-M11	33	CL-22	16	CL-731-1	4	CL-8587	8	CL-HK8347	10
AL-M11SH	31	CL-23A	16	CL-731-12	4	CL-88-12SM	4	CL-HK8587	10
AL-M12	33	CL-32	16	CL-731-34	4	CL-8832	3	CL-N0 to N9	18
AL-M13	33	CL-34	16	CL-731-58	4	CL-8832H	3	CL-SHBB	9
AL-M13SH	33	CL-35	16	CL-74X	16	CL-8832Y	3	CL-SHDD	9
AL-M14	33	CL-431	3	CL-80C	17	CL-88-34	4	CL-SHKK2	9
AL-M1SH	32	CL-431H	3	CL-81	17	CL-88-34SM	4	CL-SHRR	9
AL-M2	32	CL-431Y	3	CL-8117	8	CL-88-58	4	DUC-6154	38
AL-M2S	32	CL-440	15	CL-8127	8	CL-89BXL	15	DUC-6505	38
AL-M2SH	32	CL-5A	12	CL-82	17	CL-8X	5	DUC-6528D	39
AL-M3	32	CL-5LT	12	CL-825	3	CL-900	12	DUC-6528S	39
AL-M3SH	32	CL-612-12	8	CL-826	3	CL-901	12	DUC-6529D	38
AL-M4	32	CL-612-58	8	CL-831	3	CL-902	12	DUC-6529S	38
AL-M4SH	32	CL-65	16	CL-831H	3	CL-9050	11	DUC-6531S	38
AL-M5	32	CL-651-12	3	CL-831Y	3	CL-9050DF	11	DUC-6532S	38
AL-M5SH	32	CL-660-12	8	CL-8333	17	CL-9052	11	DUC-6533	38
AL-M6	32	CL-660-34	8	CL-8347	8	CL-9052DF	11	DUC-6535	38
AL-M6SH	32	CL-660-58	8	CL-85	17	CL-9053	11	DUC-9508	39
AL-M7	32	CL-661	6	CL-8518-12	8	CL-9054	11	DUC-9579	39
AL-M7SH	32	CL-662	4	CL-8518-58	8	CL-9054DF	11	DUC-9960	39
AL-M8	32	CL-668-12	2	CL-8521-12	8	CL-9503	10	DUC-9961	39
AL-M8SH	32	CL-668-34	2	CL-8526	8	CL-950358	10	DUC-B1	37
AL-MS13	33	CL-668-58	2	CL-8526H	8	CL-9536	7	DUC-B112	37
AL-MS14	33	CL-670	3	CL-8526Y	8	CL-9537	7	DUC-B2	37
AL-SH1	36	CL-670CF	6	CL-8526Z	8	CL-9538	7	DUC-B3	37
AL-SH112	36	CL-670H	3	CL-8527-12	8	CL-9XS-12	3	DUC-B34	37
AL-SH114	36	CL-670Y	3	CL-8527-34	8	CL-A2	17	DUC-B4	37
AL-SH2	36	CL-679XL	16	CL-8527-58	8	CL-A3	15	DUC-BH2305	37
AL-SHLL	35	CL-681	11	CL-853-12	4	CL-A to Z	18	DUC-BH2306	37
AL-SHMM	35	CL-681DF	11	CL-853-34	4	CL-BH3A	13	DUC-BH2381	37
AL-SHRR	35	CL-6LT	12	CL-853-58	4	CL-BH3B	13	DUC-BH2382	37

INDEX

Item	Page	Item	Page	Item	Page	Item	Page	Item	Page
DUC-RE100CC	41	DUC-SHR2	40	HD-13MSCSOR	57	HD-BS6	68	HD-CS5	68
DUC-RE125CC	41	DUC-SHR3	40	HD-13MSCSPB	57	HD-BS8	68	HD-CS6	68
DUC-RE4429B	41	DUC-SHR5	40	HD-13MSCSSC	57	HD-BSH112	68	HD-CS8	68
DUC-RE4429C	41	DUC-SHR60	40	HD-13MSFAB	57	HD-BSH12	68	HD-DC1107	57
DUC-RE4429E	41	DUC-SHR61	40	HD-13MSFOR	57	HD-BSH2	68	HD-DC1107W	57
DUC-RE4429L	42	DUC-TB136	37	HD-13MSFPB	57	HD-BSH212	68	HD-DC1108	57
DUC-RE4429N	41	DUC-TB196	37	HD-13MSFSC	57	HD-BSH3	68	HD-DC1108W	57
DUC-RE4429S	41	FIT-E4512	70	HD-ANI11	61	HD-BSH4	68	HD-DC1601	57
DUC-RE4429T	42	FIT-E4514	70	HD-ANI1112	61	HD-BSH5	68	HD-DC1601B	57
DUC-RE4429V	42	FIT-E4520	70	HD-ANI1114	61	HD-BSH6	68	HD-DS12	54
DUC-RE4441C	41	FIT-E4530	70	HD-ANI12	61	HD-BSH8	68	HD-DS9	54
DUC-RE4441E	41	FIT-E4540	70	HD-BC1212	54	HD-BVG3	54	HD-FRH112	70
DUC-RE4441N	41	FIT-E9010	70	HD-BC1812	54	HD-BVG4	54	HD-FRH112NH	70
DUC-RE4441S	41	FIT-E9012	70	HD-BC2458	54	HD-BVG6	54	HD-FRH114	70
DUC-RE4441V	42	FIT-E9014	70	HD-BCBRK	54	HD-BVGSP6	54	HD-FRH114NH	70
DUC-REC401LM	18	FIT-E9020	70	HD-BCL12	54	HD-BWF12	66	HD-FRH2	70
DUC-REC401RM	18	FIT-E9030	70	HD-BGHJ	55	HD-BWF34	66	HD-FSH41	65
DUC-REC421LM	18	FIT-E9040	70	HD-BGHJ34	55	HD-BWF58	66	HD-FSH4112	65
DUC-REC421RM	18	FIT-EC10	70	HD-BGHJ58	55	HD-BWM12	66	HD-FSH4114	65
DUC-REC441LM	18	FIT-EC112	70	HD-BGHJZ	55	HD-BWM34	66	HD-FSH42	65
DUC-REC441RM	18	FIT-EC114	70	HD-BH212	66	HD-BWM58	66	HD-GC2000	58
DUC-REL400L	18	FIT-EC20	70	HD-BH212R	66	HD-BXC20	54	HD-GC3000	58
DUC-REL400R	18	FIT-EC30	70	HD-BH300	66	HD-BXHDS34	55	HD-HB2	43
DUC-REL420L	18	FIT-EC40	70	HD-BH300R	66	HD-CS1	68	HD-HB3	43
DUC-REL420R	18	HD-10LSCSAB	57	HD-BH302	66	HD-CS112	68	HD-HB5ADJ	44
DUC-REL440L	18	HD-10LSCSOR	57	HD-BHDS12	55	HD-CS114	68	HD-HB5C	43
DUC-REL440R	18	HD-10LSCSPB	57	HD-BS112	68	HD-CS2	68	HD-HB5NS	43
DUC-SH362	40	HD-10LSCSSC	57	HD-BS12	68	HD-CS212	68	HD-HB5NSNP	43
DUC-SH363	40	HD-10LSFAB	57	HD-BS2	68	HD-CS214	68	HD-HB5REC	44
DUC-SH398	40	HD-10LSFORB	57	HD-BS212	68	HD-CS3	68	HD-HB7	43
DUC-SHEE	40	HD-10LSFPB	57	HD-BS3	68	HD-CS312	68	HD-HB7ADJ	44
DUC-SHGG	40	HD-10LSFSC	57	HD-BS4	68	HD-CS34	68	HD-HB7NS	43
DUC-SHMM	40	HD-13MSCSAB	57	HD-BS5	68	HD-CS4	68	HD-HB7NSNP	43

INDEX

Item	Page	Item	Page	Item	Page	Item	Page	Item	Page
HD-HB7REC	44	HD-LUGGZ	55	HD-SHX52	61	HD-TRR4	67	HD-WT210	64
HD-HB9	43	HD-MB3	65	HD-SHX53	61	HD-VDC107	57	HD-WT220	64
HD-HB9NP	43	HD-MB4	65	HD-SHX54	61	HD-VDC107W	57	HD-WT303B	64
HD-HHB	44	HD-MB6	65	HD-SOWL11	60	HD-WGFR11R	59	HD-WT304B	64
HD-HHD33	43	HD-MB8	65	HD-SOWL115	60	HD-WGFR7R	59	HD-WT305B	64
HD-HHD33S	43	HD-NR3	54	HD-SOWL12	60	HD-WGFR9R	59	HD-WT306B	64
HD-HHD44	43	HD-NR6	54	HD-SOWL125	60	HD-WGFRPBD	59	HD-WT308B	64
HD-HHD55	43	HD-OTC	56	HD-SOWL13	60	HD-WSLG	54	HD-WT310B	64
HD-HHD66	43	HD-OTC4	56	HD-SOWL515	60	HD-WT101	62	HD-WT5RB	64
HD-HHP	44	HD-OTCH	56	HD-SOWL52	60	HD-WT101XL	62	HD-WT6RB	64
HD-HHSP	44	HD-RR12	54	HD-SOWL53	60	HD-WT102	62	HD-WT7RB	64
HD-HHW	44	HD-RR3	54	HD-SOWL54	60	HD-WT102XL	62	HD-WT8RB	64
HD-HHZ	44	HD-RR3D	54	HD-SOWL55	60	HD-WT103	62	HD-WVG3	56
HD-HSD22	43	HD-RR6	54	HD-SOWL56	60	HD-WT104	62	HD-WVG4	56
HD-HSD3134	43	HD-RR6D	54	HD-ST14112	60	HD-WT104S	62	HD-WVG4N	56
HD-HSD33	43	HD-SA123	60	HD-ST142	60	HD-WT104XL	62	HD-WVG6	56
HD-HSD35225T	43	HD-SA38178	60	HD-ST143	60	HD-WT105	62	HD-WVGSP3	56
HD-HSD3535	43	HD-SA383	60	HD-TADPT	61	HD-WT106	62	HD-WVGSP4	56
HD-HSD44	43	HD-SA516112	60	HD-TOTB	59	HD-WT107	62	HD-WVGSP6	56
HD-HSP312B	44	HD-SA516212	60	HD-TOWD516	61	HD-WT108	63	IND-1013-1	94
HD-HSP312M	44	HD-SD112	65	HD-TR10	67	HD-WT109	63	IND-1013-2	94
HD-HSP412M	44	HD-SD158	65	HD-TR312	67	HD-WT110	64	IND-105-1C	78
HD-HSP4B	44	HD-SD178	65	HD-TR314	67	HD-WT113	64	IND-105-1LC	78
HD-HSP4M	44	HD-SD335	65	HD-TR4	67	HD-WT114	64	IND-105-2C	78
HD-LBAR	55	HD-SD36	65	HD-TR412	67	HD-WT115	64	IND-105-2LC	78
HD-LBARNH	55	HD-SHX1	61	HD-TR414	67	HD-WT116	64	IND-108-A-1	78
HD-LFG	55	HD-SHX115	61	HD-TR5	67	HD-WT118	64	IND-108-A-2	78
HD-LNHG	55	HD-SHX12	61	HD-TR512	67	HD-WT124	64	IND-109-3C	79
HD-LS38L	60	HD-SHX13	61	HD-TR514	67	HD-WT125	64	IND-114-5C	114
HD-LS38S	60	HD-SHX32	61	HD-TR6	67	HD-WT202	63	IND-114-8C	114
HD-LS516L	60	HD-SHX33	61	HD-TR7	67	HD-WT204S	63	IND-116A-3C	107
HD-LS516S	60	HD-SHX34	61	HD-TR8	67	HD-WT204XL	63	IND-116A-4C	107
HD-LUGGBXL	55	HD-SHX51	61	HD-TRR312	67	HD-WT209	63	IND-116A-5C	107

INDEX

Item	Page	Item	Page	Item	Page	Item	Page	Item	Page
IND-116F-1C	113	IND-126-5C	116	IND-136-4C	107	IND-148-1C	81	IND-30022	100
IND-116F-2C	113	IND-126-6C	116	IND-136-5C	109	IND-148-2C	81	IND-30024	100
IND-116F-3C	113	IND-12703	79	IND-136-6C	109	IND-149-1C	81	IND-30026	101
IND-116F-4C	113	IND-12704	77	IND-136-7C	109	IND-15-1C	94	IND-30028	101
IND-116F-5C	113	IND-12704DB	77	IND-136-8C	109	IND-154-2C	81	IND-30029	101
IND-117-2C	113	IND-12705	77	IND-137-10C	110	IND-155-1C	81	IND-30030	101
IND-117-4C	113	IND-12707	80	IND-137-7C	109	IND-155-2C	81	IND-30031	101
IND-117-6C	113	IND-12710D	80	IND-137-8C	109	IND-155-3C	81	IND-30033	101
IND-12006	77	IND-12710S	80	IND-137-9C	110	IND-155-4C	81	IND-30034	10
IND-12008	77	IND-12905	77	IND-138-10C	110	IND-155-6C	81	IND-30035	101
IND-120-1C	104	IND-12908	78	IND-138-11C	110	IND-158-1	114	IND-30036	102
IND-12026	77	IND-13026	95	IND-138-12C	110	IND-158-3C	114	IND-30037	102
IND-12027	76	IND-13027	95	IND-138-13C	110	IND-158-6C	114	IND-30038	102
IND-120-2C	104	IND-13028	95	IND-138-3C	110	IND-158B-7C	113	IND-30039	102
IND-12040	76	IND-13029	95	IND-138-4C	110	IND-159-1C	113	IND-30040	102
IND-12041	76	IND-13049	95	IND-139-1C	110	IND-159-3C	113	IND-31040	105
IND-12042	76	IND-13054	95	IND-139-3C	111	IND-159-4C	113	IND-32179	102
IND-12043	76	IND-13065	99	IND-139-4C	111	IND-159-5C	113	IND-33016	103
IND-12065	77	IND-13113	99	IND-139-5C	111	IND-159-6C	113	IND-33017	103
IND-12068	78	IND-13114	99	IND-139-6C	111	IND-159-7C	113	IND-33018	103
IND-122A-1C	104	IND-13118	99	IND-14003	82	IND-17-1C	94	IND-33019	103
IND-124-2	104	IND-13120	99	IND-14008	82	IND-17-2C	94	IND-35-1C	85
IND-125-1C	104	IND-13124	95	IND-14016	82	IND-21011	100	IND-35-2C	85
IND-126-11C	116	IND-13125	95	IND-140-1C	111	IND-21016	100	IND-36-1C	85
IND-126-12C	116	IND-136-10C	108	IND-140-2C	111	IND-21017	100	IND-36-2C	85
IND-126-13C	116	IND-136-11C	108	IND-140-3C	112	IND-21025	96	IND-37-3C	85
IND-126-14C	116	IND-136-15C	108	IND-14048	82	IND-21027	96	IND-37-4C	85
IND-126-15C	116	IND-136-16C	108	IND-14049	82	IND-24-2C	94	IND-4140-L	106
IND-126-16C	116	IND-136-17C	108	IND-140-5C	112	IND-24-3C	94	IND-4140-R	106
IND-126-1C	116	IND-136-18C	108	IND-140-6C	112	IND-26-C-1C	94	IND-42-10	116
IND-126-2C	116	IND-136-1C	107	IND-140-7C	112	IND-30013	100	IND-42-9	116
IND-126-3C	116	IND-136-2C	107	IND-140-8C	112	IND-30014	100	IND-44-12C	83
IND-126-4C	116	IND-136-3C	107	IND-140H-3C	105	IND-30021	100	IND-47-10C	83

INDEX

Item	Page	Item	Page	Item	Page	Item	Page	Item	Page
IND-47-11C	83	IND-51208	97	IND-61006	90	IND-63201	67	IND-663-8C	106
IND-47-7C	83	IND-51209	98	IND-61007	90	IND-633-2C	105	IND-678-1C	98
IND-48-1C	71	IND-51214	98	IND-61008	90	IND-64022	89	IND-678-2C	98
IND-48-1LC	71	IND-51216	98	IND-61034	91	IND-64-B-2C	74	IND-70-D-1C	76
IND-48-2C	71	IND-51-3C	73	IND-61035	91	IND-64-F-1	82	IND-70-D-5C	83
IND-48-2LC	71	IND-52-2C	73	IND-61039	91	IND-64-F-3C	74	IND-80-A-10C	86
IND-48-3C	71	IND-52-3C	73	IND-61040	91	IND-64-F-3LC	74	IND-80-A-11C	86
IND-48-3LC	71	IND-52A-4SC	74	IND-61041	91	IND-64-F-5C	74	IND-80-A-12C	86
IND-48-3SC	71	IND-52A-4SLC	74	IND-61042	91	IND-64-F-5LC	75	IND-80-A-13C	86
IND-48-4C	71	IND-53-1C	73	IND-61048	91	IND-64-F-9C	75	IND-80-A-15C	86
IND-48-4LC	71	IND-53-25C	82	IND-61049	91	IND-64-F-9DC	75	IND-80-A-17C	87
IND-49-3C	72	IND-53-347LC	73	IND-61051	91	IND-64-H-10C	83	IND-80-A-1C	86
IND-499-1	80	IND-53-3C	73	IND-61052	91	IND-64-I-2C	75	IND-80-A-22C	87
IND-499-2	80	IND-541-2C	76	IND-61121	88	IND-64-I-2LC	75	IND-80-A-23C	87
IND-50-25C	82	IND-576-2C	79	IND-61122	88	IND-64-I-3C	75	IND-80-A-24C	87
IND-50-5C	72	IND-576-4C	79	IND-61135	88	IND-64-I-3LC	75	IND-80-A-30C	87
IND-50-5LC	72	IND-598-11	115	IND-61136	88	IND-64-L-3C	79	IND-80-A-33C	87
IND-50-6C	72	IND-598-13	115	IND-61157	88	IND-64-L-4C	79	IND-80-A-3C	86
IND-50-6LC	72	IND-598-16	115	IND-61158	88	IND-64-R-3C	79	IND-80-A-9C	86
IND-50-7C	72	IND-599-1	115	IND-62001	89	IND-64-R-4C	79	IND-84-7C	87
IND-50-7LC	72	IND-599-2	115	IND-62002	89	IND-65-847LC	73	IND-90-T1	84
IND-50-8C	72	IND-599-3	115	IND-62003	89	IND-65-8C	73	IND-90-T2	84
IND-50-8LC	73	IND-599-5	115	IND-62004	89	IND-661-1C	105	IND-90-T3	84
IND-51006	96	IND-60-3C	74	IND-62005	89	IND-661-2C	105	IND-90-T4	84
IND-51007	96	IND-604-11C	111	IND-62006	89	IND-661-3C	105	IND-90-T5	84
IND-51011	96	IND-604-12C	111	IND-62007	89	IND-661-4C	105	IND-90-T6	84
IND-51012	96	IND-604-6C	80	IND-62008	89	IND-663-1C	105	IND-90-T7	84
IND-51020	96	IND-604-7C	80	IND-62-1C	99	IND-663-2C	105	IND-93-4C	88
IND-51021	96	IND-61001	90	IND-63001	67	IND-663-3C	106	IND-94-3C	88
IND-51030	97	IND-61002	90	IND-63006	67	IND-663-4C	106	IND-94-C-11	93
IND-51201	97	IND-61003	90	IND-63008	67	IND-663-5C	106	IND-94-C-12	93
IND-51202	97	IND-61004	90	IND-63102	67	IND-663-6C	106	IND-94-E-1C	93
IND-51207	97	IND-61005	90	IND-63104	67	IND-663-7C	106	IND-94-E-2C	93

INDEX

Item	Page	Item	Page	Item	Page	Item	Page	Item	Page
IND-94-E-3C	93	LCK-15-605R	52	LCK-EZS1115	49	LCK-MLK403	45	LPT-CY938026D	46
IND-94-E-4C	93	LCK-18200D	51	LCK-EZST10B	49	LCK-MLK405	45	LPT-CY938026DS	46
IND-94-E-5C	92	LCK-18200SL	51	LCK-EZST3	49	LCK-MLK411P	45	LPT-CY93803	46
IND-94-E-6C	92	LCK-18200SR	51	LCK-EZST32D	49	LCK-MLLB9300	46	LPT-CY93803S	46
IND-94-F-3C	92	LCK-18500	51	LCK-EZST5	49	LCK-MLLB9300-L	46	LPT-CY93805	46
IND-94-F-4C	92	LCK-45100L	51	LCK-EZT6113	49	LCK-NK4000LSCL	51	LPT-GL26D	48
IND-94-F-5C	92	LCK-45100R	51	LCK-EZT61132D	49	LCK-NK4000LSCR	51	LPT-GL3	48
IND-94-F-6C	92	LCK-A13-115	53	LCK-EZT6115	49	LCK-RCY92523	46	LPT-GL5	48
IND-98-1C	80	LCK-A13-215	53	LCK-EZT63310B	49	LCK-SC3	50	LPT-K924226D	46
IND-FT12A	115	LCK-DC3	50	LCK-EZT6333	49	LCK-SC32D	50	LPT-K92423	46
IND-FT16A	115	LCK-DC32D	50	LCK-EZT63332D	49	LCK-SC3L	50	LPT-K92425	46
IND-FT18A	115	LCK-DC3-L	50	LCK-EZT6335	49	LCK-SC3S	50	LPT-LH937011P	46
IND-SS1101	112	LCK-DC5	50	LCK-EZT6453	49	LCK-SC5	50	LPT-LH937026D	46
IND-SS1102	112	LCK-DC5-L	50	LCK-EZT64532D	49	LCK-SC5L	50	LPT-LH93703	46
IND-SS1103	112	LCK-EZDTLK-363	48	LCK-EZT6553	49	LCK-SLH20026D	47	LPT-LH93705	46
IND-YT12A	115	LCK-EZDTLK-365	48	LCK-KK9301	48	LCK-SLH2003	47	LPT-MK983026D	46
IND-YT16A	115	LCK-EZDTLK-3632D	48	LCK-LHM3	48	LCK-SLH53610B	47	LPT-MK98303	46
IND-YT18A	115	LCK-EZD21110B	49	LCK-LHM363	48	LCK-SLH53626D	47	LPT-MK98305	46
LCK-13-105	53	LCK-EZD2113	49	LCK-LHEsM365	48	LCK-SLH5363	47	LPT-MLBTT26D	46
LCK-13-115	53	LCK-EZD21132D	49	LCK-LHM5	48	LCK-SLH55610	46	LPT-MLBTT3	46
LCK-13-134	53	LCK-EZD2115	49	LCK-LSIPBD	50	LCK-SLH55626	46	LPT-MLBTT5	46
LCK-13-205	53	LCK-EZDT10B	49	LCK-LSIPBS	50	LCK-SLH5563	46	LPT-SCY968010B	47
LCK-13-215	53	LCK-EZDT3	49	LCK-MLH111P	45	LCK-SLH556SGL10	46	LPT-SCY968026D	47
LCK-15-125	52	LCK-EZDT32D	49	LCK-MLH1126D	45	LCK-SLH556SGL26D	46	LPT-SCY96803	47
LCK-15-150R	52	LCK-EZDT5	49	LCK-MLH113	45	LCK-SLH556SGL3	46	LPT-SCY96805	47
LCK-15-150S	52	LCK-EZLHK3	48	LCK-MLH115	45	LCK-SLLB9600	46	LPT-SDT96353	47
LCK-15-176	52	LCK-EZLHK32	48	LCK-MLH233	45	LCK-TCY938511P	46	LPT-SDT96355	47
LCK-15-225	52	LCK-EZLHK363	48	LCK-MLH235	45	LCK-TCY938526D	46	LPT-T6333-L	49
LCK-15-225NG	52	LCK-EZLHK365	48	LCK-MLK211P	46	LCK-TCY93853	46	LPT-TSCY968510B	47
LCK-15-250R	52	LCK-EZLHK5	48	LCK-MLK2226D	46	LCK-TCY93855	46	LPT-TSCY968526D	47
LCK-15-250S	52	LCK-EZS11110B	49	LCK-MLK223	46	LPT-BPH9355	46	LPT-TSCY96853	47
LCK-15-276	52	LCK-EZS1113	49	LCK-MLK225	46	LPT-CY938011P	46	LPT-TSCY96855	47
LCK-15-605L	52	LCK-EZS11132D	49	LCK-MLK4026D	45	LPT-CY938011PS	46	ORI-215-12	1

INDEX

Item	Page	Item	Page	Item	Page	Item	Page	Item	Page
ORI-215-34	1	ORI-657S	5	ORI-CIC198	15	ORI-PB115	7	ORI-S215-12	1
ORI-215-58	1	ORI-671AF	4	ORI-CIC21C	14	ORI-PB117	7	ORI-S215-34	1
ORI-215X	6	ORI-671XL	4	ORI-CIC22C	14	ORI-PB118H	7	ORI-S215-58	1
ORI-217-12	1	ORI-6732T	19	ORI-CIC23C	14	ORI-PB119H	7	ORI-S217-12	1
ORI-217-34	1	ORI-6906X	6	ORI-CIC6701	14	ORI-PB120H	7	ORI-S217-34	1
ORI-217-58	1	ORI-6914	2	ORI-CIC6702	14	ORI-PB121H	7	ORI-S217-58	1
ORI-217B-12	1	ORI-6914X	6	ORI-CIC6711	14	ORI-PB125	7	ORI-S217B-12	1
ORI-217B-34	1	ORI-810S	5	ORI-CIC6714	14	ORI-PB126	7	ORI-S217B-34	1
ORI-217B-58	1	ORI-812S	5	ORI-CIC6716	14	ORI-PB224	7	ORI-S217B-58	1
ORI-218-12	1	ORI-833	11	ORI-CIC6717	15	ORI-PB224112	7	ORI-S218-12	1
ORI-218-34	1	ORI-834S	5	ORI-CSH1	10	ORI-PB7X	6	ORI-S218-34	1
ORI-218-58	1	ORI-835	11	ORI-CSH112	10	ORI-PB7XL	6	ORI-S218-58	1
ORI-219	4	ORI-844	11	ORI-CSH114	10	ORI-RE199	12	ORI-S227-12	1
ORI-227-12	1	ORI-858S	5	ORI-CSH2	10	ORI-RE199L	12	ORI-S227-34	1
ORI-227-34	1	ORI-9H	2	ORI-HK-1	8	ORI-RE199XL	12	ORI-S227-58	1
ORI-227-58	1	ORI-9Y	2	ORI-HK-12	8	ORI-RE201	12	ORI-S251-1	1
ORI-227X	6	ORI-9Z	4	ORI-HK-34	8	ORI-RE201L	12	ORI-S251-12	1
ORI-251-1	1	ORI-BC1	11	ORI-HK-58	8	ORI-RE201XL	12	ORI-S251-34	1
ORI-251-12	1	ORI-BC112	11	ORI-L649H	2	ORI-RE6928	12	ORI-S251-58	1
ORI-251-34	1	ORI-BC12	11	ORI-L649Y	2	ORI-RE6928L	12	ORI-S260-12	1
ORI-251-58	1	ORI-BC134	11	ORI-L649Z	2	ORI-RE6928XL	12	ORI-S260-34	1
ORI-260-12	1	ORI-BH93R	13	ORI-L655	2	ORI-REC401L	18	ORI-S260-58	1
ORI-260-34	1	ORI-CIC141	7	ORI-L655H	2	ORI-REC401R	18	ORI-SH352	10
ORI-260-58	1	ORI-CIC142	7	ORI-L655Y	2	ORI-REC421L	18	ORI-SH353	10
ORI-270-12	2	ORI-CIC143	7	ORI-L656H	2	ORI-REC421R	18	ORI-SH354	10
ORI-270-34	2	ORI-CIC144	7	ORI-L656Y	2	ORI-REC441L	18	ORI-SH356	10
ORI-270-58	2	ORI-CIC145	7	ORI-L659H	2	ORI-REC441R	18	ORI-SH357	10
ORI-271-1	4	ORI-CIC146	7	ORI-L659Y	2	ORI-REL400L	18	ORI-SH653	13
ORI-272-1	4	ORI-CIC147	7	ORI-L659Z	2	ORI-REL400R	18	ORI-SH654	13
ORI-273-1	4	ORI-CIC148	7	ORI-P6000	19	ORI-REL420L	18	ORI-SHCC	9
ORI-413X	6	ORI-CIC149	7	ORI-P6002	19	ORI-REL420R	18	ORI-SHDD	9
ORI-414X	6	ORI-CIC150	7	ORI-P6031	19	ORI-REL440L	18	ORI-SHDD34	9
ORI-657P	19	ORI-CIC197	15	ORI-PB114	7	ORI-REL440R	18	ORI-SHEE	9

INDEX/CHARTS

Item	Page	Item	Page
ORI-SHHH	9	PLS-CAPR12W	69
ORI-SHLL	9	PLS-CAPR1W	69
ORI-SHMM	9	PLS-CAPR2	69
PLS-CAP1	69	PLS-CAPR2W	69
PLS-CAP112	69	PLS-CAPR3	69
PLS-CAP112W	69	PLS-CAPR34	69
PLS-CAP114	69	PLS-CAPR34W	69
PLS-CAP114W	69	PLS-CAPR3W	69
PLS-CAP12	69	PLS-CAPR58	69
PLS-CAP12W	69	PLS-CAPR58W	69
PLS-CAP1NW	69	PLS-P21512	69
PLS-CAP1W	69	PLS-P21534	69
PLS-CAP1X112	69	PLS-P21558	69
PLS-CAP1X112W	69	PLS-P215B12	69
PLS-CAP1X2	69	PLS-P217B12	69
PLS-CAP1X2W	69	PLS-P217B34	69
PLS-CAP2	69	PLS-P217B58	69
PLS-CAP2NW	69	PLS-P227B12	69
PLS-CAP2W	69	PLS-P227B34	69
PLS-CAP3	69	PLS-P227B58	69
PLS-CAP34	69		
PLS-CAP34W	69		
PLS-CAP34X112	69		
PLS-CAP34X112W	69		
PLS-CAP3RW	69		
PLS-CAP58	69		
PLS-CAP58W	69		
PLS-CAPR1	69		
PLS-CAPR112	69		
PLS-CAPR112W	69		
PLS-CAPR114	69		
PLS-CAPR114W	69		
PLS-CAPR12	69		

B & S Gauge	Inch (Decimal)	Millimeter (mm)	Inch (Fraction)	B & S Gauge	Inch (Decimal)	Millimeter (mm)	Inch (Fraction)
1	0.289	7.348	.	17	0.045	1.149	.
2	0.258	6.543	.	18	0.040	1.024	.
.	0.250	6.350	1/4	19	0.036	0.912	.
.	0.234	5.953	15/64	20	0.032	0.812	.
3	0.229	5.827	.	.	0.031	0.795	1/32
.	0.219	5.556	7/32	21	0.028	0.723	.
4	0.204	5.189	.	22	0.025	0.644	.
.	0.203	5.154	11/64	23	0.023	0.573	.
.	0.188	4.762	3/16	24	0.020	0.511	.
5	0.182	4.621	.	25	0.018	0.455	.
.	0.172	4.366	11/64	26	0.016	0.405	.
6	0.162	4.115	.	.	0.016	0.396	1/64
.	0.156	3.969	5/32	27	0.014	0.360	.
7	0.144	3.664	.	28	0.013	0.321	.
.	0.141	3.572	9/64	29	0.011	0.286	.
8	0.128	3.263	.	30	0.010	0.255	.
.	0.125	3.175	1/8	31	0.0089	0.226	.
9	0.114	2.906	.	32	0.0080	0.200	.
.	0.109	2.778	7/64	33	0.0071	0.180	.
10	0.102	2.588	.	34	0.0063	0.160	.
.	0.094	2.381	3/32	35	0.0056	0.142	.
11	0.091	2.304	.	36	0.0050	0.130	.
12	0.081	2.052	.	37	0.0045	0.114	.
.	0.078	1.984	5/64	38	0.0040	0.100	.
13	0.072	1.828
14	0.064	1.628
.	0.063	1.588	1/16
15	0.057	1.449
16	0.051	1.291
.	0.047	1.191	3/64

MATH CONVERSION CHART – WEIGHT (US)

METRIC CONVERSIONS			
1 gram	=	1000 milligrams	1g = 1000 mg
1 kilogram	=	1000 grams	1 kg = 1000 g
1 tonne (1 megagram)	=	1000 kilograms	1 tonne = 1000 kg (1 Mg)

STANDARD CONVERSIONS			
1 ounce	=	16 drams	1 oz = 16 dr
1 pound	=	16 ounces	1 lb = 16 oz
1 hundredweight	=	100 pounds	1 cwt = 100 lb
1 ton (short)	=	20 hundredweight	1 ton = 20 cwt
1 ton (short)	=	2000 pounds	1 ton = 2000 lb

METRIC -> STANDARD CONVERSIONS			
1 gram	=	0.035274 ounces	1 g = 0.035274 oz
1 kilogram	=	2.20462 pounds	1 kg = 2.20462 lb
1 kilogram	=	35.27396 ounces	1 kg = 35.27396 oz
1 tonne	=	1.10231 ton, short	1 tonne = 1.10231 ton, short

STANDARD -> METRIC CONVERSIONS			
1 ounce	=	28.34952 grams	1 oz = 28.34952 g
1 pound	=	453.59237 grams	1 lb = 453.59237 g
1 pound	=	0.45359 kilograms	1 lb = 0.45359 kg
1 hundredweight	=	50.8023 kilograms	1 cwt = 50.8023 kg